

Faster Charging Comes Home





Smart EV Charger

Quick Installation Guide











This guide will help you installing and setting up your Smart EV Charger

Package Contents

-  EV Charger cable
-  Wall-mounted bracket
-  Smart EV Charger
-  Cable lock

Required Equipment

-  Pencil
-  Level
-  Screwdriver 4 mm
-  Allen key
-  Smartphone
-  Stud finder
-  Drill
-  3-5 Screws
-  3-5 Wall anchors



ENERGY STAR® certified Smart EV Charger



Scan QR code for installation video

solaredge

/ INSTALLING

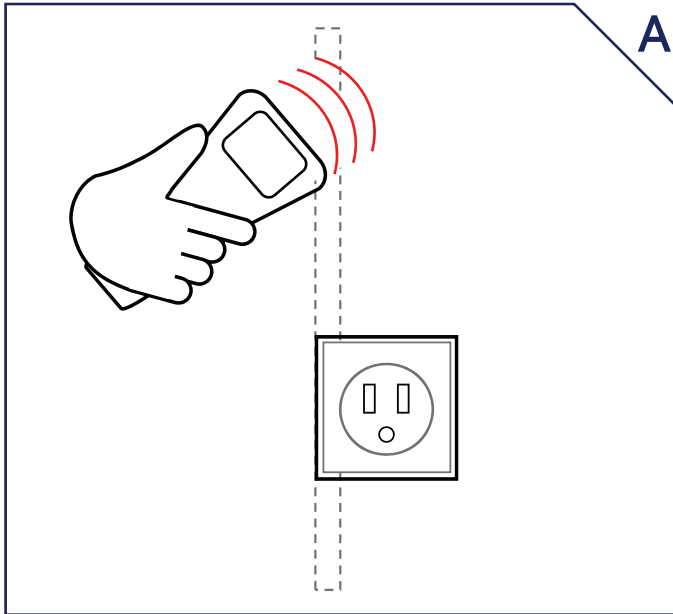

Use a stud finder to locate studs around the power outlet

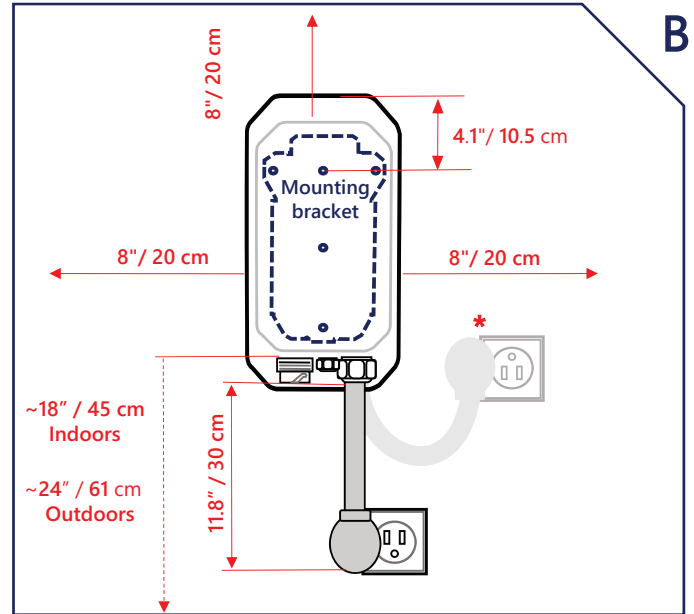

Dimensions: 30.5 cm (H) X 19 cm (W) X 15.4 cm (D)
12" (H) X 7.5" (W) X 6" (D)

* If the socket is installed upside down, move the Smart EV Charger closer to the power outlet, loop the lead and plug-in

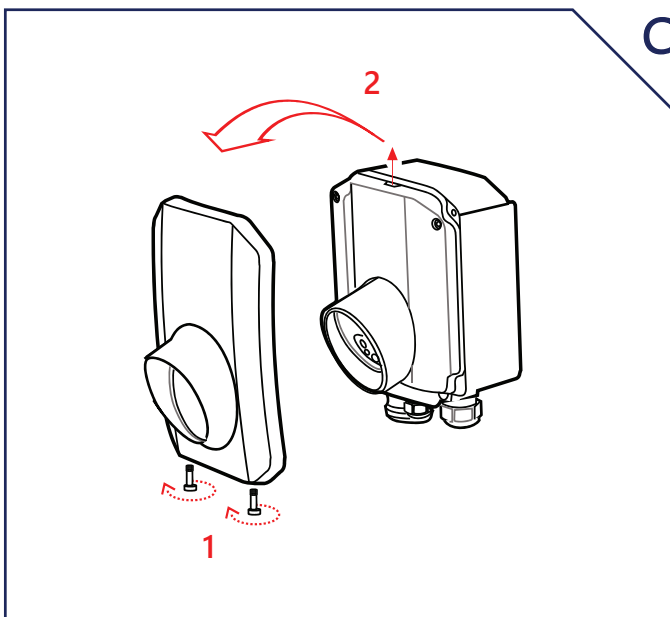

1. Release the two bolts connecting the front cover
2. Remove the front cover from the Smart EV Charger

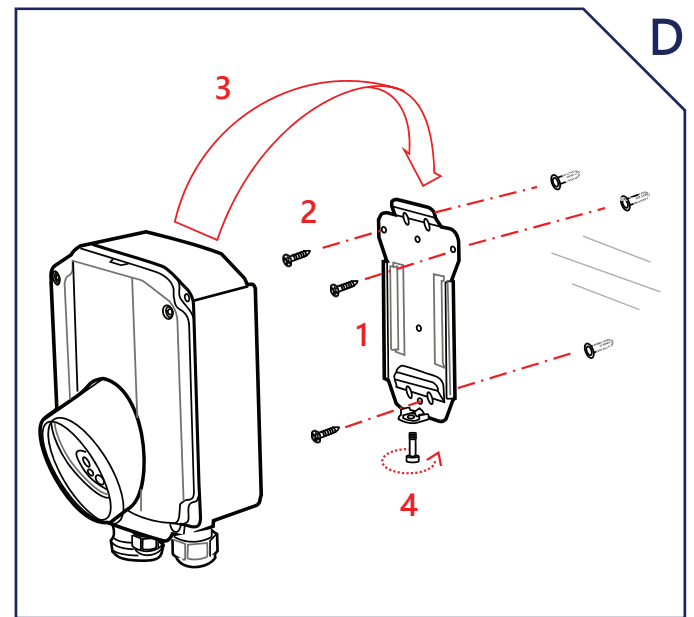

1. Level the bracket on the wall and use it as a template for marking holes. Drill holes in the shown locations (use more holes for greater stability). Insert the wall anchors to the holes. If studs are used, use screws that penetrate studs
2. Fasten the bracket to the wall with screws
3. Slide the Smart EV Charger down over the bracket
4. Secure the bolt

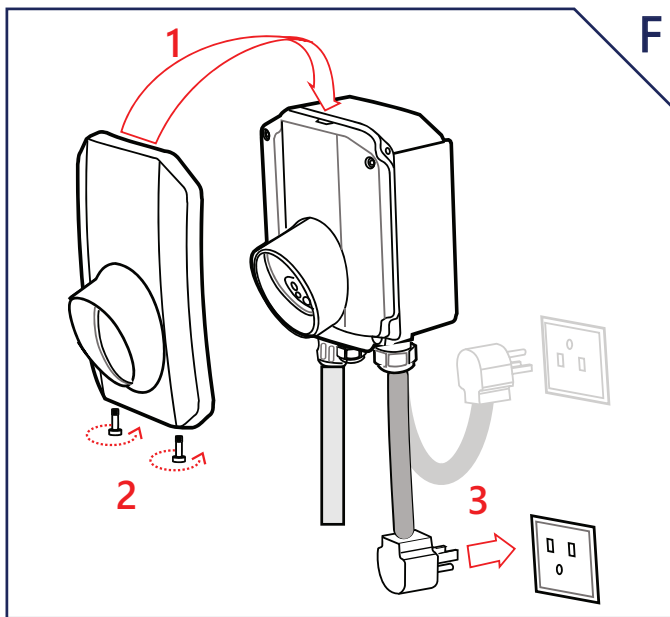
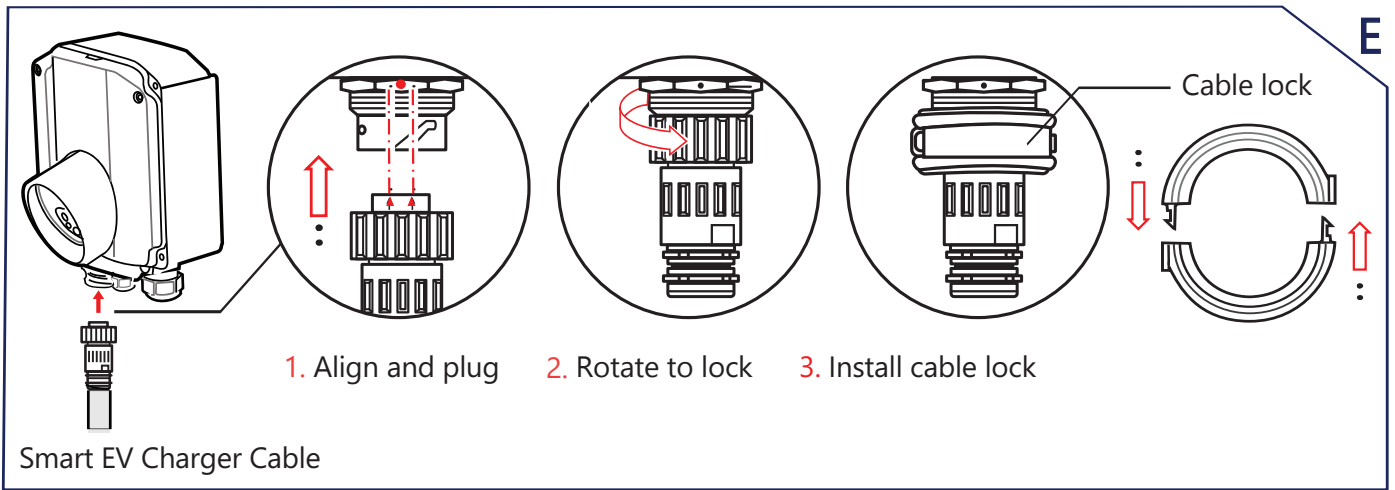

1. Place the front cover onto the Smart EV Charger
2. Secure the two bolts
3. Insert the AC plug into the power outlet

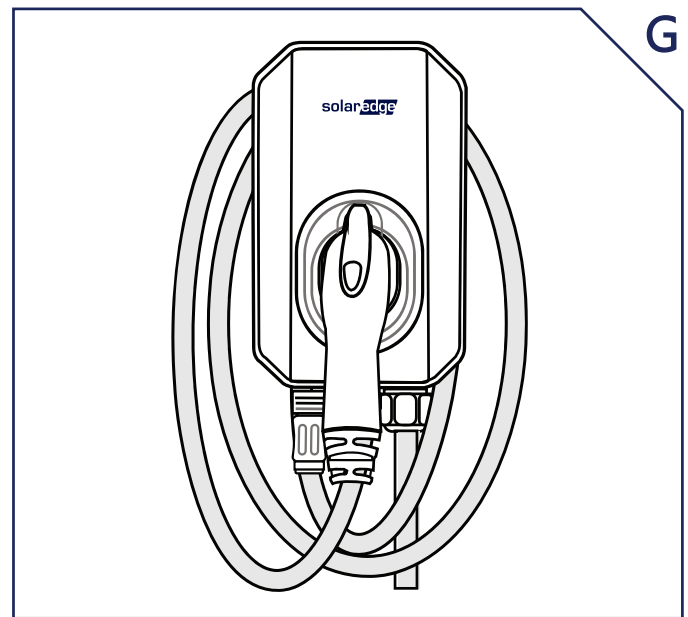

Wind the Smart EV Charger Cable around the Smart EV Charger

/ SETTING UP

mySolarEdge is an app used for scheduling charging and monitoring status of the Smart EV Charger through the Internet.

The Smart EV Charger, can be paired directly with a smartphone and set over Wi-Fi (no internet is required).

To start charging:

1. Scan the QR code to download mySolarEdge to your smartphone
2. Start  mySolarEdge and follow the on-screen instructions
3. Long press the Push Button
4. Scan the QR Code Pairing Label for setting up the Smart EV Charger

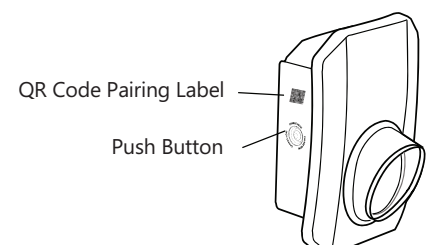

/ CHARGING

Plug the Smart EV Charger cable into the vehicle charging port. The LED Ring Indicator will illuminate orange, indicating that charging is in progress. Once charging is complete, press the Lock Release Button, remove the cable from your vehicle and wind the cable around the Smart EV Charger.

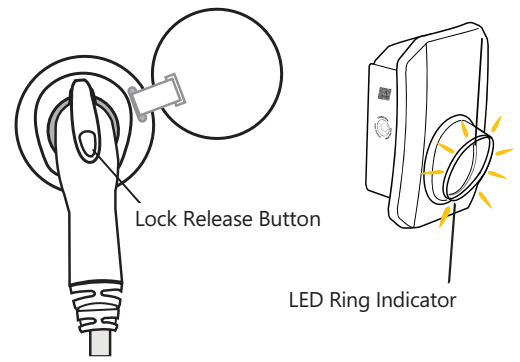

Push Button Functions

- Short press
 - Start charging immediately, even if the Smart EV Charger is in scheduling mode
 - Quickly restart the Smart EV Charger in case of an error
- Long press
 - Turns on the Wi-Fi to enable pairing with a smartphone (refer to mySolarEdge)

LED Ring Indications

Color	Description
OFF	No power
Red ON	Error
Green ON	Charging and connected to Internet
Green blinking	Connected to EV and connected to Internet
Green pulsating ⁽¹⁾	Not connected to EV but connected to Internet
Orange ON	Charging but not connected to Internet
Orange blinking	Connected to EV but not connected to Internet
Orange pulsating ⁽¹⁾	Not connected to EV and not connected to Internet
Purple blinking fast	Smart EV Charger is ready to connect to smartphone for setting up
Purple momentarily ON	Smart EV Charger is connected to smartphone for setting up

⁽¹⁾The light switches on slowly and gradually increases up to maximum and then slowly decreases back to off

Buzzer Indications

Indication	Description
1 short beep	Connected to EV
2 short beeps + 1 long beep	Charging starts
5 short beeps	Error



Scan QR code for installation manual



YOU'RE ALL SET FOR SMART EV CHARGING!

About SolarEdge

SolarEdge is a global leader in smart energy technology. By deploying world-class engineering capabilities and a relentless focus on innovation, we create smart energy products and solutions that power our lives and drive future progress

- SolarEdge
- @SolarEdgePV
- @SolarEdgePV
- SolarEdgePV
- SolarEdge
- info@solaredge.com

solaredge

solaredge.com

© SolarEdge Technologies, Ltd.
All rights reserved.
Rv: 01/2020/V01/ENG EU.
Subject to change without notice.

