



# EV Charging Inverter Activation & Cable Installation Guide





This guide will help you install your EV Charger cable, activate your EV Charging Inverter and configure it to fit your needs

## Package Contents

-  EV Charger cable
-  Wall-mounted holder (screws not included)
-  Cable lock & installation guide

## Required Equipment

-  4 screws
-  Screwdriver
-  Drill

**solar**edge

# / CONNECTING & HANGING

**i**

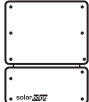
**A.** Make sure inverter is installed 

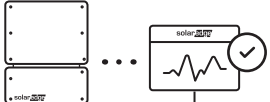
**B.** Make sure inverter is connected to SolarEdge monitoring platform 

## 1 Connect EV Charger Cable to Inverter

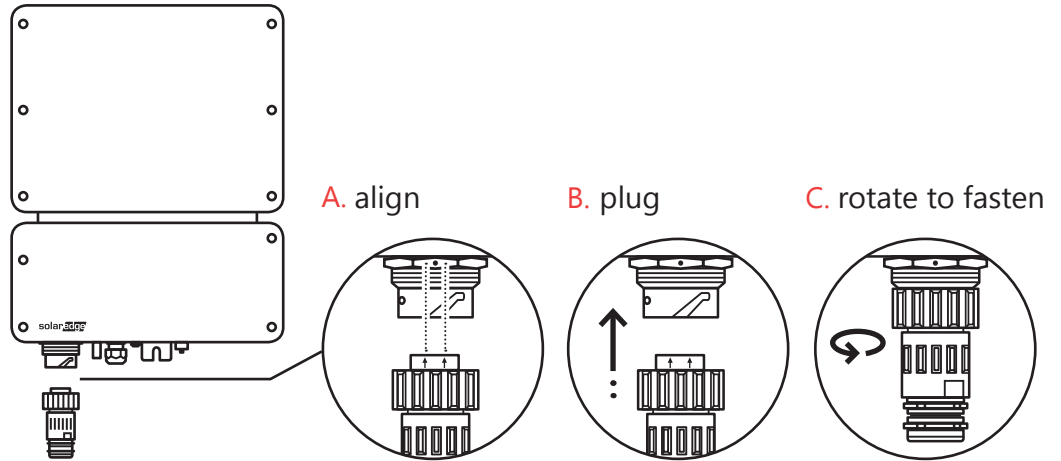

## 2 Determine Mounting Location

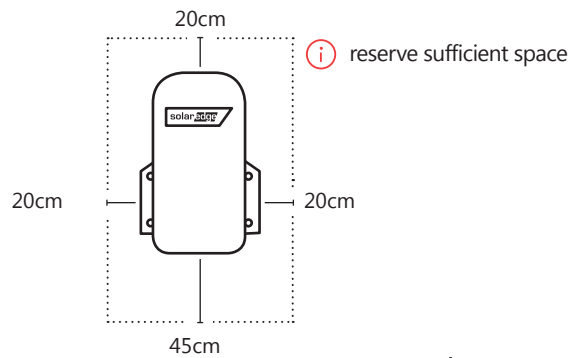

**i** To install the cable lock, refer to the separate installation guide

## 3 Mount Cable Holder

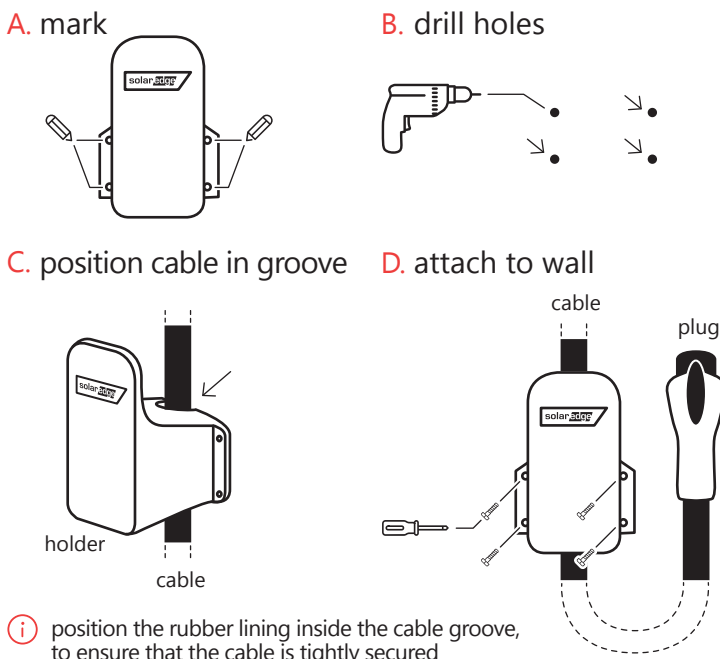

## 4 Hang Cable On Holder

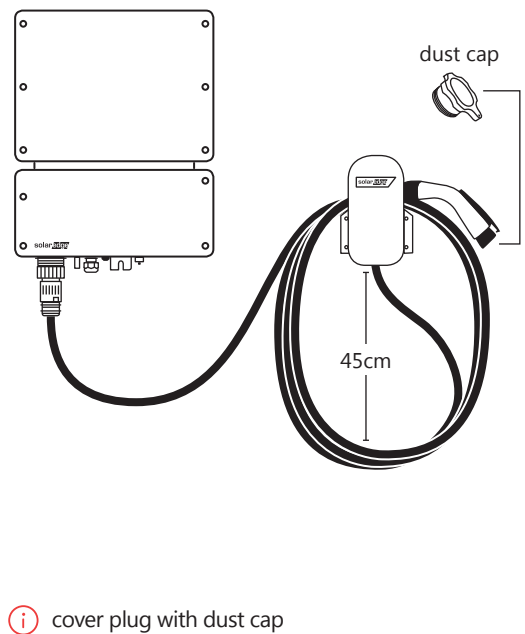

# / ACTIVATING & CONFIGURING



Connection to the SolarEdge Monitoring Platform is required for first time EV charging\*.  
For questions please contact your installer.

## 1

### DOWNLOAD APP & LOG IN



For iPhone



For Android

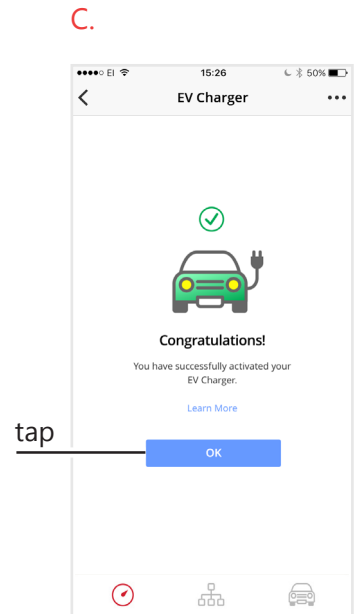
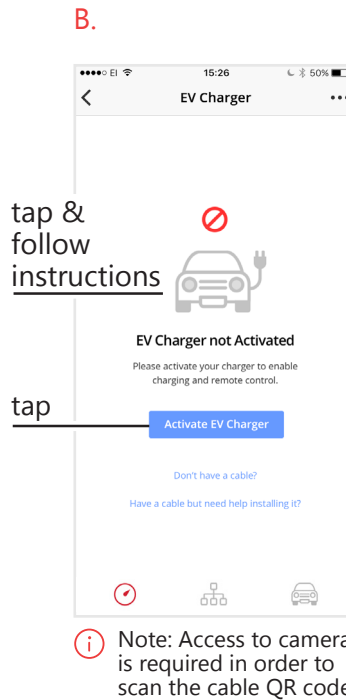
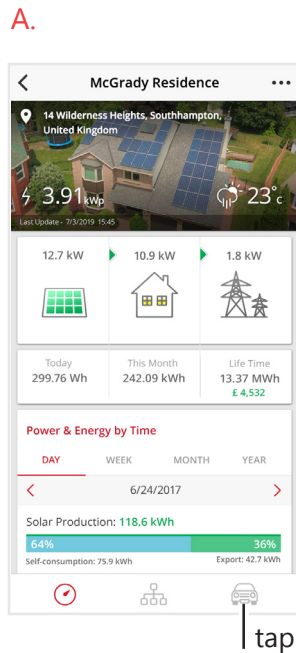

## 2

### CONFIGURE

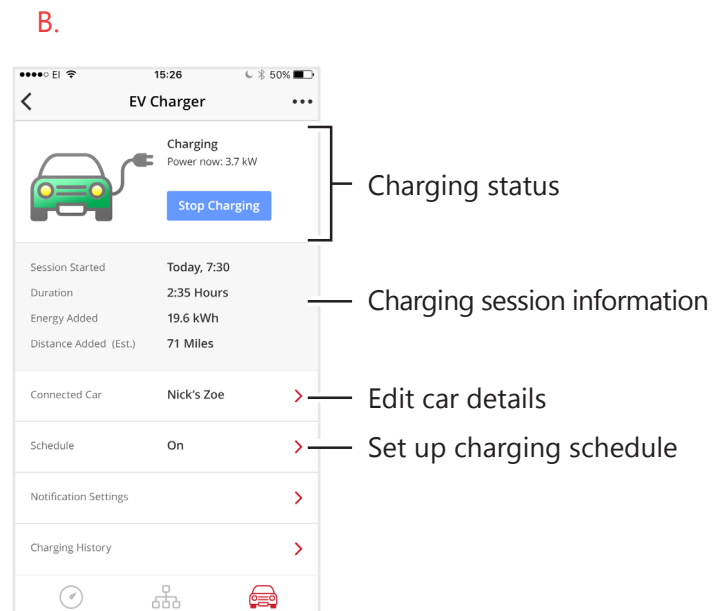
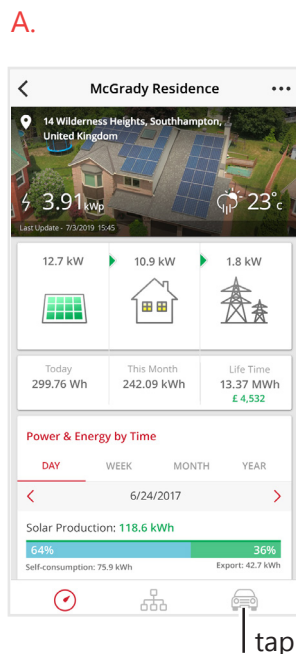

**YOU'RE ALL SET!  
GET READY TO START CHARGING FROM THE SUN**

\*Connection options: Ethernet/Wi-Fi/Cellular (connection with 50MB data plan (purchased from a cellular provider). The SolarEdge data plan is < 50MB and can be used for activation only, not for EV charging configuration and monitoring

# / CHARGING

1

Verify that the green LED at the bottom of the inverter is flickering or blinking, indicating that the EV Charger is ready to charge.

2

Hold the EV Charger plug and disconnect the cable from the holder.

3

Connect the EV Charger plug to the charging socket of the vehicle and push firmly until it clicks into the socket. The inverter will sound 1 short beep and the green LED will start blinking to indicate a proper connection. The charging starts automatically, indicated by 2 short beeps followed by 1 long beep and the green LED is ON.

4

When the charging is complete, the green LED starts blinking.

5

Press the EV Charger plug latch and pull it from the EV charging socket.

6

Wind the EV Charger cable on the holder and connect the EV plug.

 For all LED indications and additional charging configurations, refer to the EV Charging Inverter installation guide and videos: [solaredge.com/products/ev-charger/activation-and-configuration](https://solaredge.com/products/ev-charger/activation-and-configuration)

# / LED

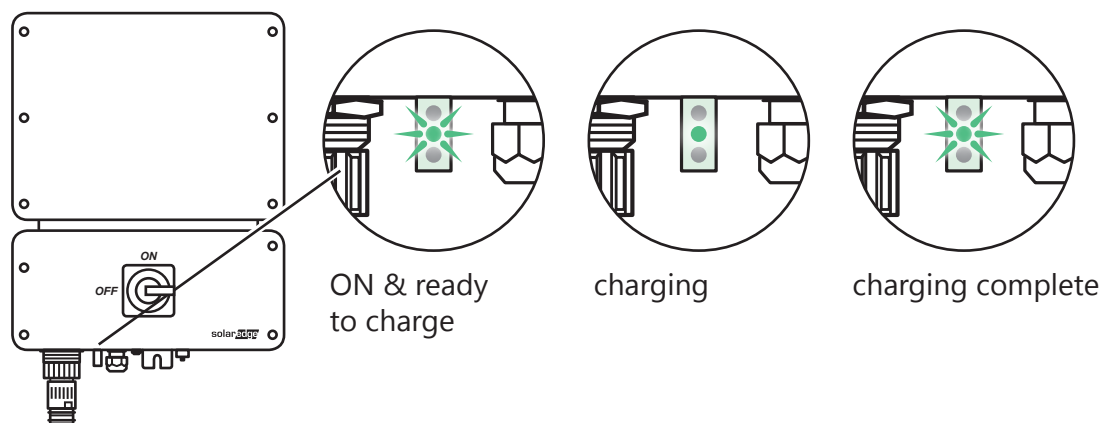

## About SolarEdge

SolarEdge is a global leader in smart energy technology. By deploying world-class engineering capabilities and a relentless focus on innovation, we create smart energy products and solutions that power our lives and drive future progress



 SolarEdge  
 @SolarEdgePV  
 @SolarEdgePV  
 SolarEdgePV  
 SolarEdge  
 [info@solaredge.com](mailto:info@solaredge.com)

**solaredge**  
[solaredge.com](https://solaredge.com)

© SolarEdge Technologies, Ltd.  
All rights reserved.  
Rv: 03/2019/V02/ENG EU.  
Subject to change without notice.