

EL7-I

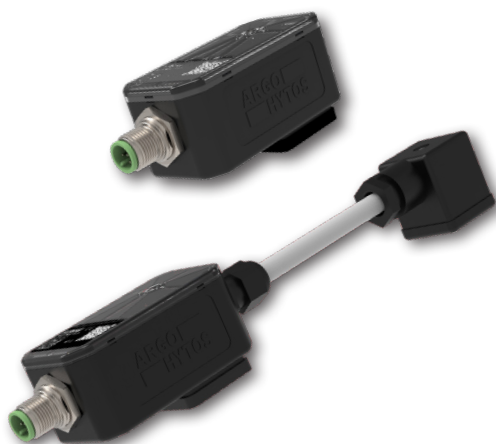

Technical Features

- › Digital electronic control unit in the form of DIN connector plug designed to control of single or double solenoid hydraulic valves
- › Wide range of supply voltage from 9 up to 32 V DC
- › Easy parameter setting via Bluetooth – class 2
- › Android + iOS application for parameter setting and monitoring, also suitable for servicing
- › Controlled by analogue input command signal or by connection to CAN bus line (protocol EN 50325-4 + DS408)
- › Optional type of input command signal
- › Wide setting range of frequency 80 ... 1000 Hz of PWM output control signal to solenoid coil
- › Amplitude and frequency of dither are adjustable separately for each solenoid (at the fixed PWM frequency 15 kHz)
- › Resistant to interferences, electrostatic discharge and quick transients
- › Resistant to mechanical shocks and vibrations
- › Flexible and reliable function of system achieved by using a fast 32-bit ultra-low-power processor
- › The 12-bit A/D converter assures high resolution and accuracy conversion of input command signal

Functional Description

The digital electronic control unit is designed to control single or double solenoid hydraulic valves in an open control loop without feedback. The advantage is a miniature design in the form of DIN connector plug and easy mounting on the valve. The ECU for single solenoid valve is simply mounted on the socket of connector EN 175301-803-A of solenoid coil. The ECU for double solenoid valve is connected to the connector plug of the second coil with a cable. A five-pin connector with the thread M12x1 is used for voltage supply of ECU in the range 9 ... 32 V DC and a transfer of input command signal. Parameter setting, such as selecting the type of input command signal, setting the ramp function or PWM frequency of output control signal, is performed via Bluetooth in the application designed for installation on android and iOS. The application also enables parameter monitoring, which is advantageous especially in installing or servicing the equipment. The coil control with PWM signal reduces energy consumption, coil heating, hysteresis and increases the control accuracy.

Technical Data

Operating supply voltage U_{cc}	V DC	9 ... 32		
Reference voltage U_{ref}	V DC	5		
Max. current at U_{ref}	mA	20		
Type of input command signal (see table page 3)		0 ... 20 mA, 4 ... 20 mA, 0 ... +5 V DC, ± 5 V DC, 0 ... 10 V DC, ± 10 V DC, $U_{cc}/2 \pm 5$ V DC, $U_{cc}/2 \pm 10$ V DC		
Max. output current / 1 coil	A	3		
PWM frequency	Hz	80 ... 1000		
Resolution of A/D converters	bit	12		
Ramp function	s	0 ... 45		
Dither – amplitude *	% from I_{max}	0 ... 30 % from I_{max}		
Dither – frequency *	Hz	60 ... 300		
Linearity	%	1		
Ambient operating temperature	°C (°F)	-40 ... +80 (-40 ... +176)		
Ingress protection code (IP) EN 60529		IP65 / IP67		
Weight	1 solenoid	kg (lbs)	0.06 (0.13)	
	2 solenoids		0.10 (0.22)	
Nominal voltage of coil			12 DC	
			24 DC	
Limit current through the valve coil	PRM2-04	A	(coil 16186100) ... 1.7	(coil 16186200) ... 0.8
	PRM2-06		(coil 16187500) ... 1.6	(coil 16186800) ... 1.0
	PRM6-10		(coil 16195800) ... 1.9	(coil 16196200) ... 1.1
	PRL1-06		-	-
	PRL2-06		-	-

* When dither is activated, the PWM frequency is automatically set to 15 kHz

Performed type tests

1. Electromagnetic interference immunity and electric strength

Standard	Standard name
DIN EN 61000-4-2	Test Standard for Electrostatic Discharge (ESD) Immunity
DIN EN 61000-4-3	Radiated, Radiofrequency, Electromagnetic Field Immunity Test
DIN EN 61000-4-4	Electrical Fast Transient (EFT) / EMC Burst Immunity Test Standard
DIN EN 61000-4-5	Surge Immunity Test
DIN EN 61000-4-6	Immunity to Conducted Disturbances, Induced by Radio Frequency Fields
DIN EN 61000-4-8	Power Frequency Magnetic Field Immunity Test

2. Electromagnetic compatibility (EMC)

EN 61000-6-2	Electromagnetic compatibility (EMC). Part 6-2: Generic standards. Immunity standard for industrial environments
EN 61000-6-4	Electromagnetic compatibility (EMC) - Part 6-4: Generic standards - Emission standard for industrial environments

3. Resistance to mechanical shocks and vibrations

Mechanical shocks and vibrations	Vibrations: sine wave 10 g, max. amplitude 0.75 mm, 10-2000 Hz, Mechanical shocks: 30 g, half sine wave 11 ms
----------------------------------	---

Ordering Code

EL7-I - -	
Electronic control unit EL7-I designed for connector	
Design type Integrated on the valve	
Input command signal analogue digital CANopen	A C
	1 2 3
	Distance between the fixing screws of ECU and connector plug of the second coil (for double solenoid valves only) 96 96 mm (for directional control valve size 04) 105 104.5 mm (for directional control valve size 06) 145 144.5 mm (for directional control valve size 10)
	Type of controlled valve single solenoid valve double solenoid valve valve with bipolar linear motor

Types of integrated electronic control unit

Electronics	Controlled valve
EL7-IA-1	Single solenoid valve with an analogue input command signal
EL7-IC-1	Single solenoid valve and a connection to CAN bus line
EL7-IA-3	Valve with a bipolar linear motor and an analogue input command signal
EL7-IC-3	Valve with a bipolar linear motor and a connection to CAN bus line
EL7-IA-2-96	Double solenoid valve size 04 with an analogue input command signal
EL7-IA-2-105	Double solenoid valve size 06 with an analogue input command signal
EL7-IA-2-145	Double solenoid valve size 10 with an analogue input command signal
EL7-IC-2-96	Double solenoid valve size 04 and a connection to CAN bus line
EL7-IC-2-105	Double solenoid valve size 06 and a connection to CAN bus line
EL7-IC-2-145	Double solenoid valve size 10 and a connection to CAN bus line

Connectors has to be ordered **separately**, see datasheet **K_KM_ha8008**.

Design	Order number
KM5-A-B	41349600
KM5-S-B	31614900

A - angeled
B - black
S - straight

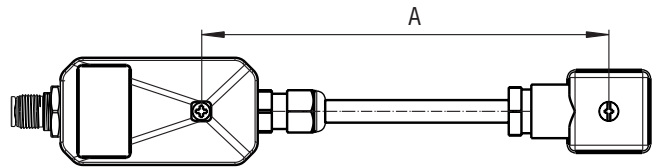

Length of connecting cable (for double solenoid valves only)
defined as a distance between the fixing screws of ECU and connector plug of the second coil (see picture)

	96 mm (3.78 in) - for directional control valve size 04
A	104.5 mm (4.11 in) - for directional control valve size 06
	144.5 mm (5.69 in) - for directional control valve size 10

Dimensions in millimeters (inches)

Type of controlled valve

- 1 - single solenoid valve
- 3 - valve with a bipolar linear motor

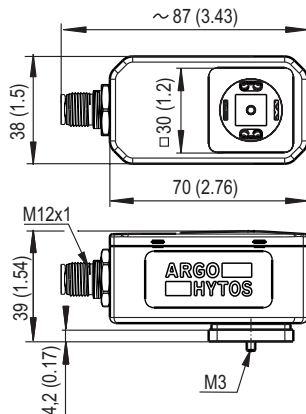

Type of controlled valve

- 2 - double solenoid valve

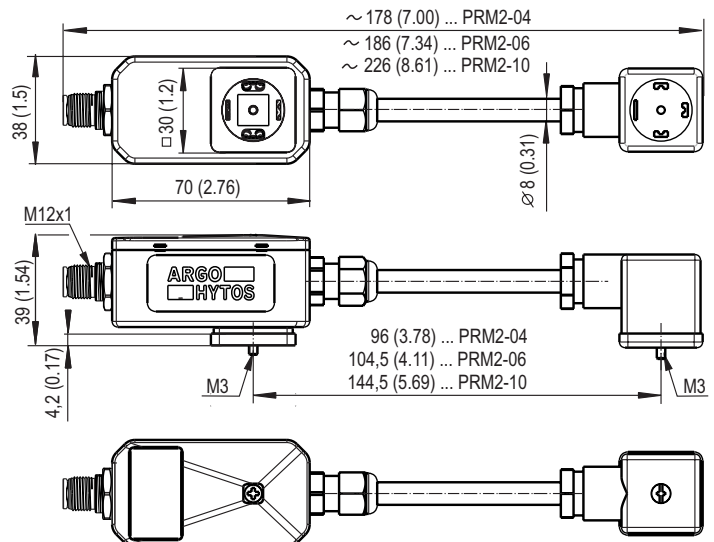

Connection of electronic control unit

Connector connection

Pin No.	Input analogue signal	Connection to CAN bus line
1	Supply voltage +Ucc	Supply voltage +Ucc
2	Supply GND	Supply GND
3	Input command signal	CAN GND
4	Input signal GND	CAN HIGH
5	Output Uref = 5 V DC	CAN LOW

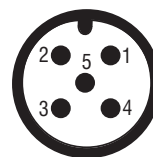

LED mode indication

LED	Meaning
Green (PWR)	A lit LED indicates power (Ucc), flashes when the supply voltage is less than 9 or more than 32 V DC
Blue (BT)	LED flashes – Bluetooth is unpaired / LED is lit - Bluetooth is paired
Red (ERR)	LED is lit – error status (current signal out of specified range, solenoid coil disconnected)

Block diagram EL7

IN type selection of input command signal (and controlled valve)
 +/- polarity inverting of input command signal
 PN insensitivity zone (dead band) setting
 OFFSET position setting of the characteristic
 GAIN gain (amplification) setting

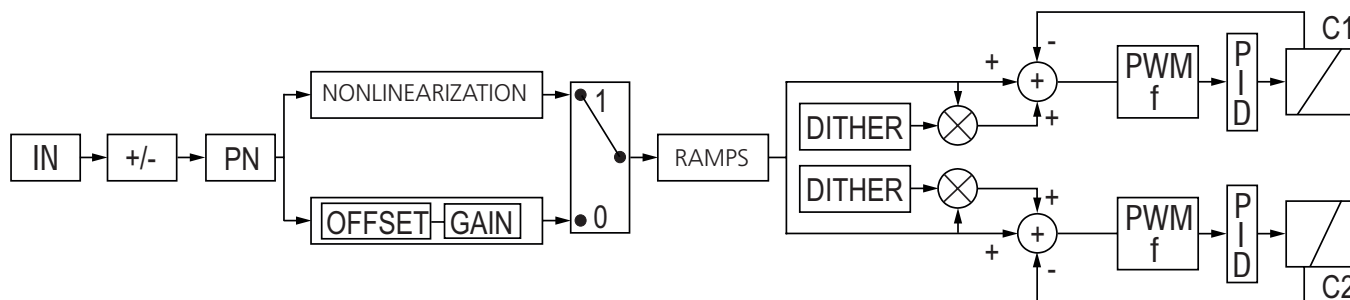

RAMP 0 - 45 s
 DITHER 60 - 300 Hz / 0 - 30 % of the amplitude
 PWM frequency 80 - 1000 Hz / 15 kHz when the dither is used
 PID setting the PID controller parameters
 C1, C2 coils of valve solenoids

Supply voltage	9 ... 32 V DC
Operating temperature	-40 ... +80 °C (-40 ... +176)

Adjustable parameters of electronic control unit

Command signal setting

Valve type	EL7 type	Input command signal
Single solenoid valve with an analogue input signal	EL7-IA-1	0 ... 20 mA 4 ... 20 mA 0 ± 10 mA -10 ... +10 V DC 0 ± 10 V DC Ucc/2 ± 10 V DC Ucc/2 ± 5 V DC 0 ... 5 V DC*
Double solenoid valve with an analogue input signal	EL7-IA-2	10 ± 10 mA 12 ± 8 mA 0 ± 10 mA 5 ± 5 V DC 0 ± 10 V DC Ucc/2 ± 10 V DC Ucc/2 ± 5 V DC 2.5 ± 2.5 V DC*
Valve with bipolar linear motor and an analogue input signal	EL7-IA-3	10 ± 10 mA 12 ± 8 mA 0 ± 10 mA 5 ± 5 V DC 0 ± 10 V DC Ucc/2 ± 10 V DC Ucc/2 ± 5 V DC 2.5 ± 2.5 V DC*
Single solenoid valve with a digital input signal (CAN)	EL7-IC-1	The type of input command signal is not selected. The input signal is generated in a digital form by control unit of machine.
Double solenoid valve with a digital input signal (CAN)	EL7-IC-2	
Valve with bipolar linear motor and a digital input signal (CAN)	EL7-IC-3	

*inputs primarily intended for control using Uref

Polarity inverting of the input command signal

In the case of single solenoid valve the input command signal is inverted. In the case of double solenoid valve or a valve with a bipolar linear motor the inverted input command signal changes the movement direction of piston rod of controlled hydraulic cylinder or rotation direction of shaft of hydraulic motor.

Insensitivity zone (dead band) setting

This function allows setting the width of the area around zero point (in % of the maximum value of input command signal), in which the output control signal for valve coils is equal to zero. The function is used in the practise as a measure against excessive sensitivity and for stability increasing of regulated system.

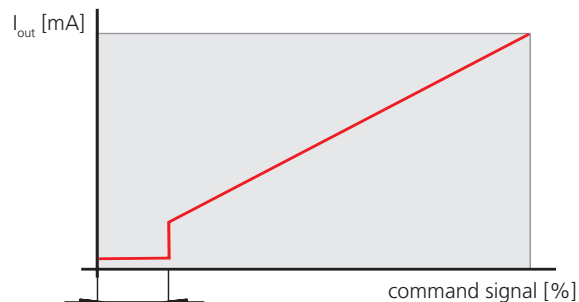

Linearization function

The function can be switched off. When is on, the shape of the characteristic „output control signal as a function of input command signal“ can be modified by entering ten values of input signal.

Gain (amplification) setting

The function allows to set a velocity of rising of the output control signal with increasing input command signal in the range $0 < \text{gain} \leq 4$

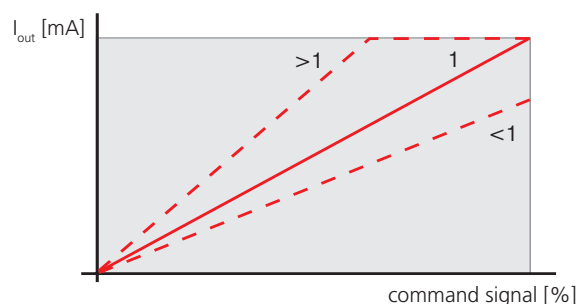

Default position of characteristic (Offset)

The function allows to set the default position of characteristic by moving in the vertical direction. This function can be used to elimination of insensitivity zone around zero point, caused by overlap of spool control edges.

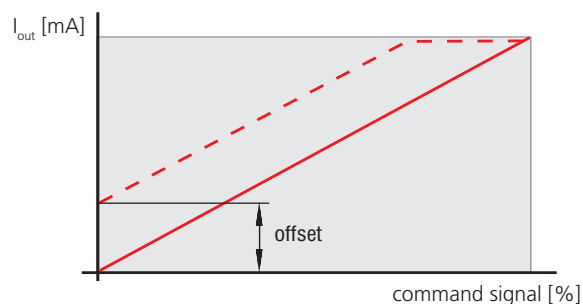

Ramp function

The function allows to define a time in the range from 0 up to 45s, which is needed for increase of input (and output) signal from zero to maximum and vice versa. The setting of ascending and descending part of characteristic reduces the dynamic transients and protects the circuit against mechanical stress.

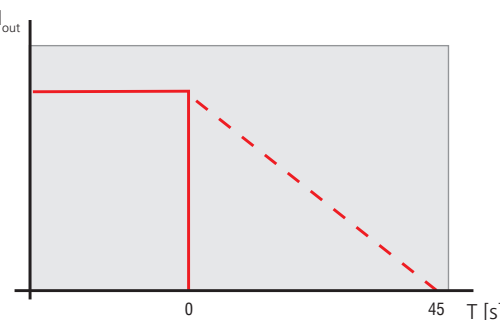
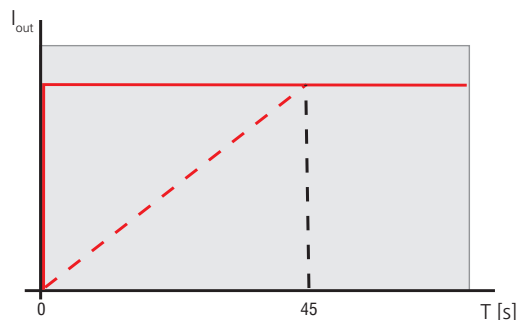

Dither

The function dither significantly reduces the effect of adhesive forces on the solenoid armature and valve spool. The adhesive oil layer counteracts the increasing solenoid force and thus prevents movement in the range of small actuating current. The permanent vibration of the armature, induced by current pulses of high frequency and low amplitude through the coil, significantly reduces the insensitivity zone. The frequency can be set from 60 up to 300 Hz, the amplitude from 0 up to 30% of maximum coil current. When the dither function is switched on, the PWM frequency of output control signal is automatically set to the value 15 kHz.

Frequency setting of PWM output control signal to the valve coils

A pulse width modulated (PWM) signal is used as an output control signal. Its frequency can be set in the range from 80 to 1000 Hz. The PWM signal reduces coil heating and improves the dynamic of valve control.

PID controller

The setting of constant of individual components of PID controller is performed by the manufacturer within the initial setting and final functional test. However, the user can change the set parameters with the help of application.

Coil limit current setting

The function is used as a protection of coil winding from current overloading but can also be used for setting of limited coil power. The maximum current value must not exceed the value indicated on the coil mantle.

Download the application for setting parameters

The application, which is stored in Android Market and Apple Store, can be obtained by reading the QR-code according to the type of your device.



Setting parameters of ECU using the application

	<p>Before getting in to the application itself do not forget to turn on your Bluetooth and Location setting on your smartphone. Right after loading of the application, follow the instructions displayed on the screen of your device and select desired ECU in the list of shown reachable devices.</p>
	<p>You will be asked for password by the application. For default setting use password 1234.</p>

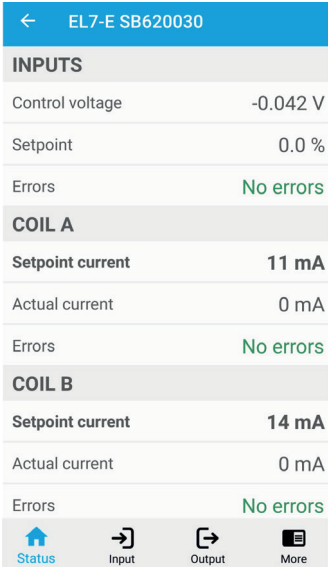
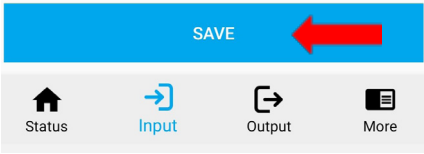
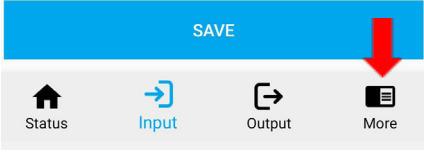
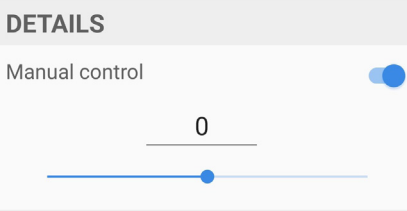
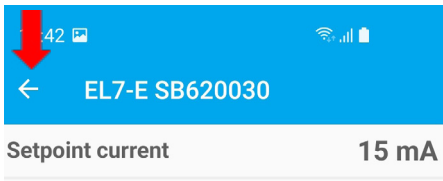
	<p>After logging in you will be displayed actual status page of EL7, including error message status. Use the icons below for switching between themselves.</p>
	<p>Changed settings can be saved in the memory of EL7 after clicking on button „Save“.</p>
	<p>After the click on the button „MORE“ you can personalize your device by setting name, password, update firmware or download system log.</p>
	<p>By checking the box of „Manual control“ the regulated valve will stop responding to the external command signal and will only be controlled by slider in the application. To return to an external control is necessary to untick the option of „Manual control“.</p>
	<p>After setting the required parameters, you can quit the application or start a parametrization of another ECU.</p>