



INSTALLATION MANUAL
VENGEANCE REAR BUMPER
PRODUCT NUMBER: E495X
APPLICATION: 2020 CHEVROLET 2500



IMPORTANT SAFETY GUIDE | Your safety and the safety of others is very important.

In order to help you make informed decisions about safety, we have provided the following warnings, safety precautions, installation instructions, and other important information to alert you to potential hazards that could hurt you or others.

Please do a job safety analysis before each task to identify potential hazards for your situation and remove/protect against them. Use own good judgment and take your time.

Check packaged materials immediately upon arrival to ensure that all listed parts are included and undamaged.

Read and understand all warnings, safety precautions, and instructions before installing this product.

SENSORS FIELD OF VIEW MAY BE ALTERED WITH USE OF THE REPLACEMENT BUMPER.

WARNINGS

- Failure to observe the following warnings and instructions provided in this manual could lead to severe injury and/or death.
- For professional installation only. Careless installation and/or operation can result in serious injury, death, and/or equipment damage. All liability for installation and use rests with the user or consumer.
- Fab Fours, Inc. only approves installing this product according to these written instructions with the hardware provided. Failure to install according to these instructions will invalidate the warranty. This includes, but is not limited to, using alternative installation methods, hardware, or materials.
- This product is for off road use only.

SAFETY PRECAUTIONS

- Always remove jewelry and wear eye protection.
- Always use extreme caution when jacking up a vehicle for work. Set emergency brake and use tire blocks. Locate and use the vehicle manufacturers designated lifting points. Use jack stands.
- Always use appropriate and adequate care in lifting components into place.
- Always ensure components will remain secure during installation and operation.
- Always wear safety glasses when installing this kit. A drilling operation will cause flying metal chips. Flying chips can cause serious eye injury.
- Always use extreme caution when drilling a vehicle. Always disconnect power before welding. Thoroughly inspect the area to be drilled (on both sides of material when possible) prior to drilling, and relocate any objects that may be damaged.
- Always use extreme caution when welding a vehicle. Thoroughly inspect the area to be welded (on both sides of material when possible) prior to welding, and relocate any objects that may be a fire hazard. When welding in a cab, make sure the interior surfaces are covered (e.g., welding blanket) and a fire extinguisher is at hand.
- Always use extreme caution when cutting and trimming during fitting.
- Always tighten all nuts and bolts securely per installation instructions.
- Always route electrical cables carefully. Avoid moving parts, components that become hot, and rough or sharp edges.
- Always insulate and protect all exposed wiring and electrical terminals.
- Perform regular inspections and maintenance on mounts and hardware.

TABLE OF CONTENTS

- 2 SAFETY / DISCLAIMER
- 3 TABLE OF CONTENTS
- 4 A MESSAGE FROM THE OWNER
- 5 GETTING STARTED
- 6 PROVIDED MATERIAL
- 7 DISASSEMBLY
- 11 INSTALLATION
- 15 CONTACT

A MESSAGE FROM THE OWNER



Fab Fours' was born out of a passion for customizing vehicles and a love of the outdoors. Our engineering team uses the latest 3D design software to turn new product ideas into reality. In our factory, designs come to life with the combination of cutting edge technology for metal cutting and forming and an American workforce that puts its' heart and pride into every product.

From design and manufacturing, to quality and delivery, Fab Fours' mission is to be the market leader for steel truck and jeep accessories. We make sure a quality product is delivered on time, more than expected, better than expected to our customers.

Enjoy your new Fab Fours product. Welcome to the family!

Ereg Higgs

FOUNDER, FAB FOURS

GETTING STARTED

Before you begin the installation process of your new Fab Fours product, we suggest laying out all materials and parts on a pad or protective surface.

Failure to fully account for all components before beginning installation may leave vehicle immobile until part is acquired. Refer to the next pages as an inventory check.

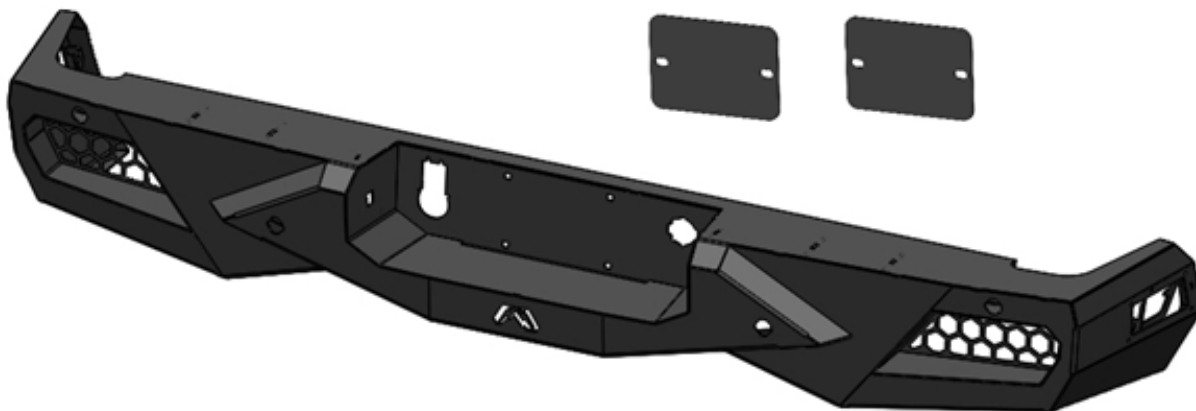

PROVIDED MATERIALS



EPOXY

61632
QTY: 2

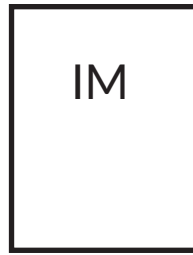

IM

E495X-IM



HW
KIT

50210-HW

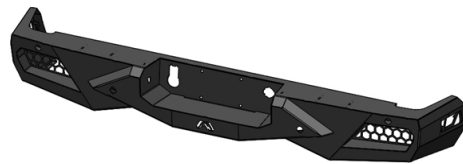

22072



22074



22074

HARDWARE KIT | 50210

FAB FOURS IDENTIFICATION	COMPONENT DESCRIPTION	QTY
50210-HW	Plastic License Plate Nut	4
50210-HW	#8 SAE Flat Washer, Stainless Steel	12
50210-HW	#8-32 3/4" Button Head Cap Screw, Stainless Steel	6
50210-HW	#8-32 Nylock Hex Nut, Stainless Steel	6
50210-HW	7/16" Yellow Zinc Lock Washer, Grade 8	4
50210-HW	7/16" Yellow Zinc Flat Washer, Grade 8	8
50210-HW	7/16"-14, Yellow Zinc Hex Nut, Grade 8	4
50210HW	7/16"-14, Yellow Zinc Hex Head Bolt, Grade 8	4
50210-HW	1 3/8" Rubber Grommet	4
50210-HW	3/4" Plastic Plug	4

TOOLS REQUIRED

- Plastic panel pry tool
- 7mm Socket wrench
- 13mm Socket wrench
- 18mm socket wrench
- 15mm socket wrench
- 3/32 Allenw wrench
- 11/32 Socket wrench
- 11/16 Socket wrench
- Flat head screw driver
- 5/8 Socket wrench

ASSISTANCE

We recommend two people perform the installation as items are heavy and may need to be held in place while installing.

ORGANIZATION

Disassemble the vehicle where you can catalog and store everything. We suggest labeling and bagging all the OEM bolts when removing from the vehicle. Failure to keep track of parts could lead to an inability to properly reinstall components.

DISASSEMBLY

1. From under the truck unplug all wire harnesses including sensor, keyless entry, trailer plug and camera. (Figure 1&2)

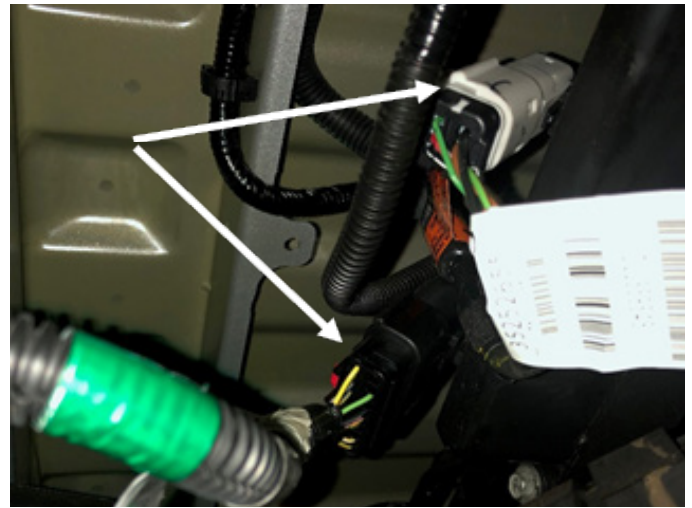

Figure 1



Figure 2

2. Use a 15mm socket wrench to remove the outside support bracket bolt on the driver and passenger sides. (Figure 3)



Figure 3

3. Use a 13mm socket wrench to remove the two bolts from behind the license plate. (Figure 4)



Figure 4

4. Use an 18mm socket wrench to remove the two (2) nuts from the mounting plate on both the driver and passenger side. With assistance, remove the bumper from the OEM truck. (Figure 5)

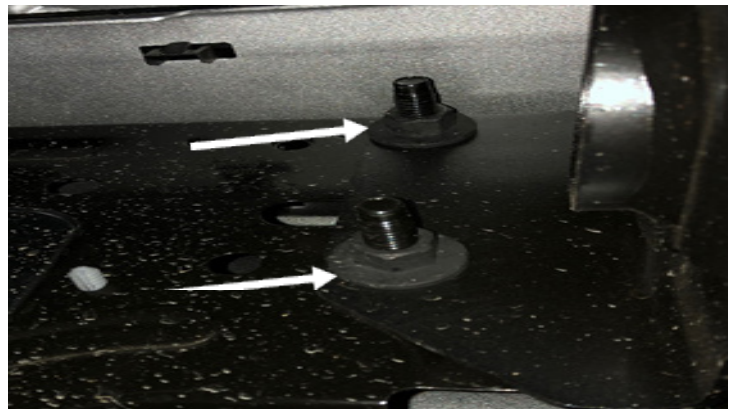

Figure 5

5. With the bumper, press in the two clips on the trailer plug and push out to remove it from the bumper. (Figure 6)

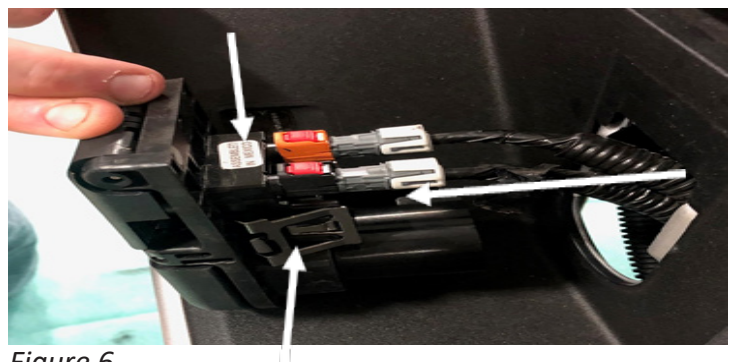

Figure 6

6. Remove the spare tire lock by pressing the clips in and pushing out. (Figure 7)



Figure 7

7. If equipped, remove the blind spot sensors from the OEM bumper using a 7mm socket wrench to remove the two bolts. (Figure 8)



Figure 8

8. Use a 7mm socket wrench to remove the sensor from its plastic casing. (Figure 9)



Figure 9

9. Use a 7mm socket wrench to remove the two license plate lights from the OEM bumper. To unplug the lights, turn the connector counterclockwise. (Figure 10)



Figure 10

10. To remove the four (4) sensors: Carefully spread the housing clips and push the sensor out of the housing (Figure 11). With the sensor removed, press the four (4) tabs in and push the housing out of the bumper. (Figure 12)

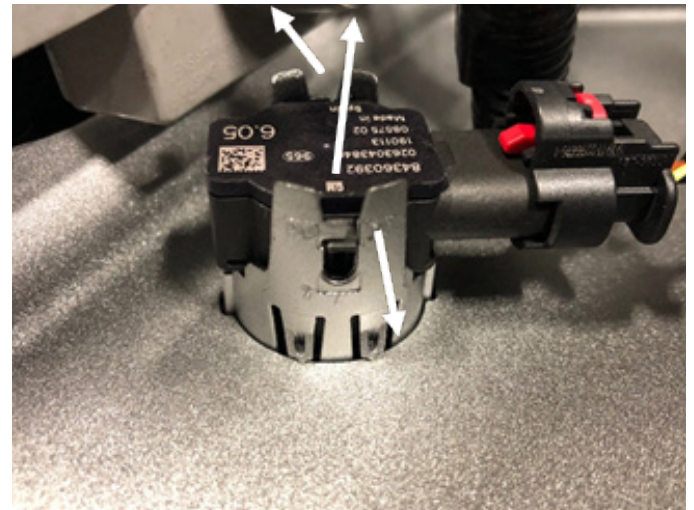

Figure 11

NOTE: Label each sensor housing to insure it is placed in the correct place when installed into the Fab Fours bumper.

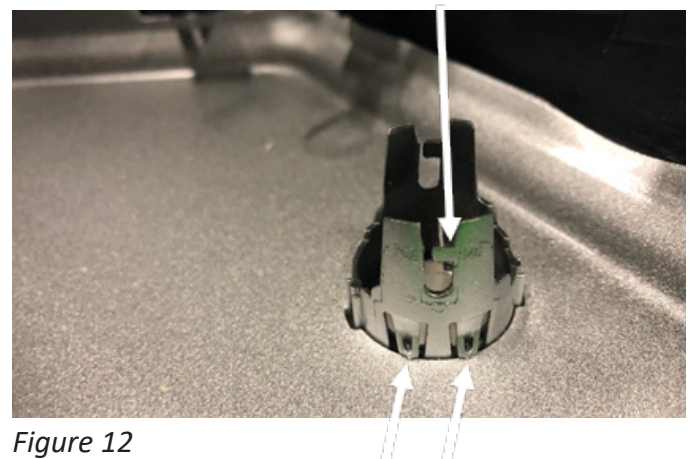

Figure 12

INSTALLATION

11. Remove the keyless entry sensor from behind the license plate by pressing in the three (3) clips and pushing it out. (Figure 13)

12. Remove the sensor harness from the bumper by unclipping it and set it aside for later use.

13. Install the keyless entry sensor to the license plate bracket using zip ties. The sensors can now be plugged in. (Figure 14)

14. Use a 3/32 allen wrench and 11/32 socket wrench to install the blind side sensors with a #8-32 bolt, flat washers and nylock nut (50210-HW). ***NOTE: If not equipped with Blind side sensors use the cover plates (22074) to cover the sensor holes.*** (Figure 15)

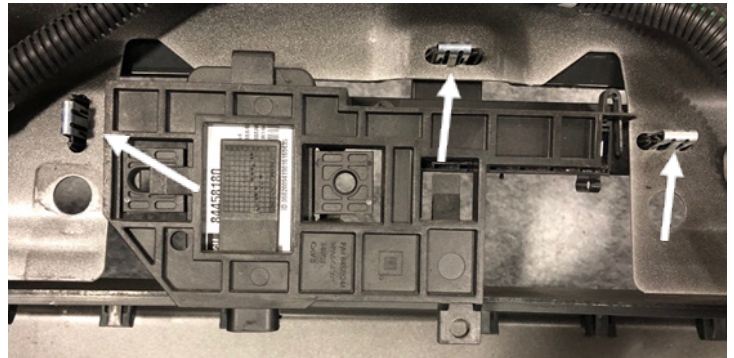

Figure 13



Figure 14



Figure 15

15. Use a 3/32 allen wrench and 11/32 socket wrench to install the license plate lights with a #8-32 bolt, flat washers and nylock nut (50210-HW). (Figure 16)

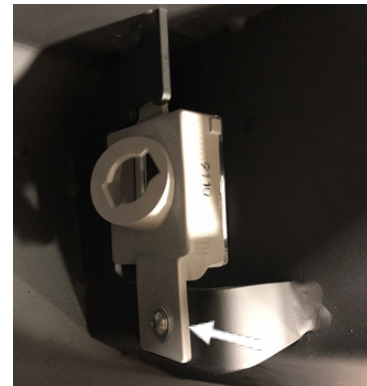

Figure 16

16. Install the spare tire access key by pushing it through the bumper and engaging the clips to hold it in place. (Figure 17)



Figure 17

17. Install the trailer plug by pushing it through the bumper and use a flat screwdriver to engage the clips on either side. (Figure 18)



Figure 18

18. Install the sensor housings into the same locations as OEM and use epoxy (61632) to lock the housing in place. Once the epoxy is dry push the sensors into the housing. Feed the harness behind the mounting plates and plug the license plate lights and blind side sensors in. (Figure 19)



Figure 19

19. If your truck is not equipped with sensors, use the rubber grommets and plugs to fill the sensor holes (50210-HW). (Figure 20)

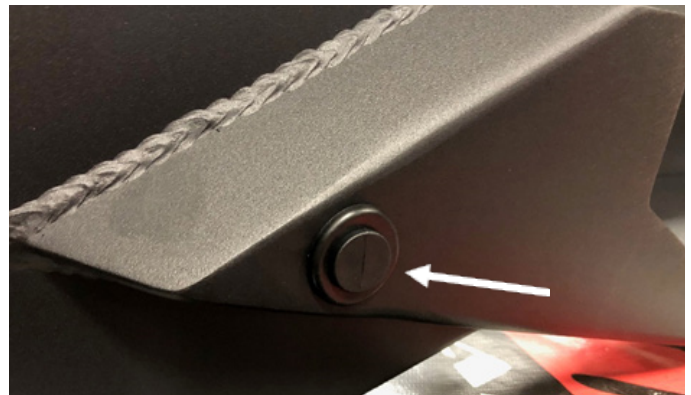

Figure 20

20. With assistance, hold the bumper up to the mounts and use a 11/16 and 5/8 socket wrench to install the bumper with the 7/16" bolts, flat and lock washers with nuts (50210-HW). (Figure 21)



Figure 21

21. Plug in all the sensor harnesses and install the four plastic license plate nuts by pushing them into the bumper (50210-HW). (Figure 22)



Figure 22

CONTACT INFORMATION

**FAB FOURS INC.
2213 INDUSTRIAL PARK ROAD
LANCASTER, SC 29720**

**PHONE: (866) 385-1905
FAX: 866-574-1423
EMAIL: SUPPORT@FABFOURS.COM
WWW.FABFOURS.COM**



**“IF YOU’RE LOOKING FOR MORE OF THE SAME,
THEN YOU’VE COME TO THE WRONG PLACE.”**

- GREG HIGGS

