



Alliant Power Application Guide



LIMITED WARRANTY POLICY

The following limited warranty applies to US and Canadian customers only.

Alliant Power warrants our products to be free from defects in material or workmanship in accordance with the following:

The warranty period commences the day the product is delivered to the original consumer purchaser. Alliant Power warrants that it will credit or replace, free of charge, any product which, under normal conditions of use and service, proves to be defective in material or workmanship and which is within the warranty period below.

Warranty Coverage

The Alliant Power Limited Warranty **COVERS** and therefore **INCLUDES**:

- Defective parts in material and workmanship
- Labor costs for removal & reinstallation of affected parts*
- Unlimited miles/kilometers on installed parts within the first 13 months after commencement of part warranty period

Warranty Exclusions

The Alliant Power Limited Warranty **DOES NOT COVER** and therefore **EXCLUDES**:

- Labor costs incurred in diagnosis of defects or any other consequential expenses
- Failures caused by fuel or oil contamination, fire damage, misuse, negligence, modification, abuse, improper application, installation, or operation
- Failures caused by unauthorized service or use of unauthorized parts

This warranty is in lieu of all other express and implied warranties, including the implied warranties of merchantability and fitness for a particular purpose. Alliant Power does not assume any responsibility for incidental or consequential damages. This warranty sets out your exclusive remedies with respect to the products covered by it. No attempt to alter, modify, or amend this warranty shall be allowed.

Some countries, states, provinces, and other jurisdictions do not allow limitations on how long implied warranties last, or the exclusion or limitation of incidental or consequential damages, so the above limitations or exclusions may not apply to you. This warranty gives you specific legal rights, and you may also have other rights which vary from country to country or state to state or province to province or jurisdiction to jurisdiction.

***Note:** Removal and reinstallation labor reimbursement is issued in accordance with the most recent version of the Alliant Power warranty repair flat rate labor schedule.

For Additional Information Visit alliantpower.com

TABLE OF CONTENTS

FORD

7.3 L Power Stroke	4
6.0 L and 4.5 L Power Stroke.....	14
6.4 L Power Stroke	28
6.7 L Power Stroke	35



NAVISTAR

T444E.....	38
VT365, VT275, MaxxForce 5.....	45
MaxxForce 7	55
DT466E, I530E, DT466 / 530, HT530	60
Perkins 1300 Series EDi, Detroit Diesel Series 40E, AGCO 9675	66
DT466 / 570, HT570, MaxxForce DT / 9 / 10	68

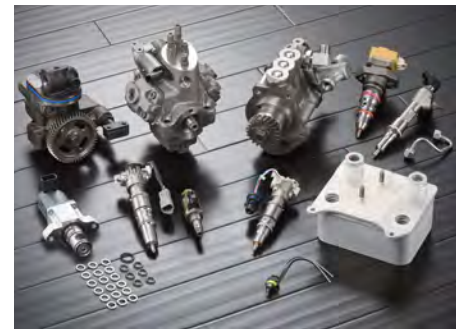

GM

6.5 L.....	78
6.6 L Duramax.....	81



DODGE/CUMMINS

Engines with PT Pumps	88
5.9 L	89
6.7 L	93



SPRINTER/JEEP

2.7 L and 3.0 L	96
-----------------------	----



TOOLS

Ford / Navistar	100
-----------------------	-----

INDEX

OEM Part Number Cross Reference.....	101
Alliant Power Part Number Index.....	108

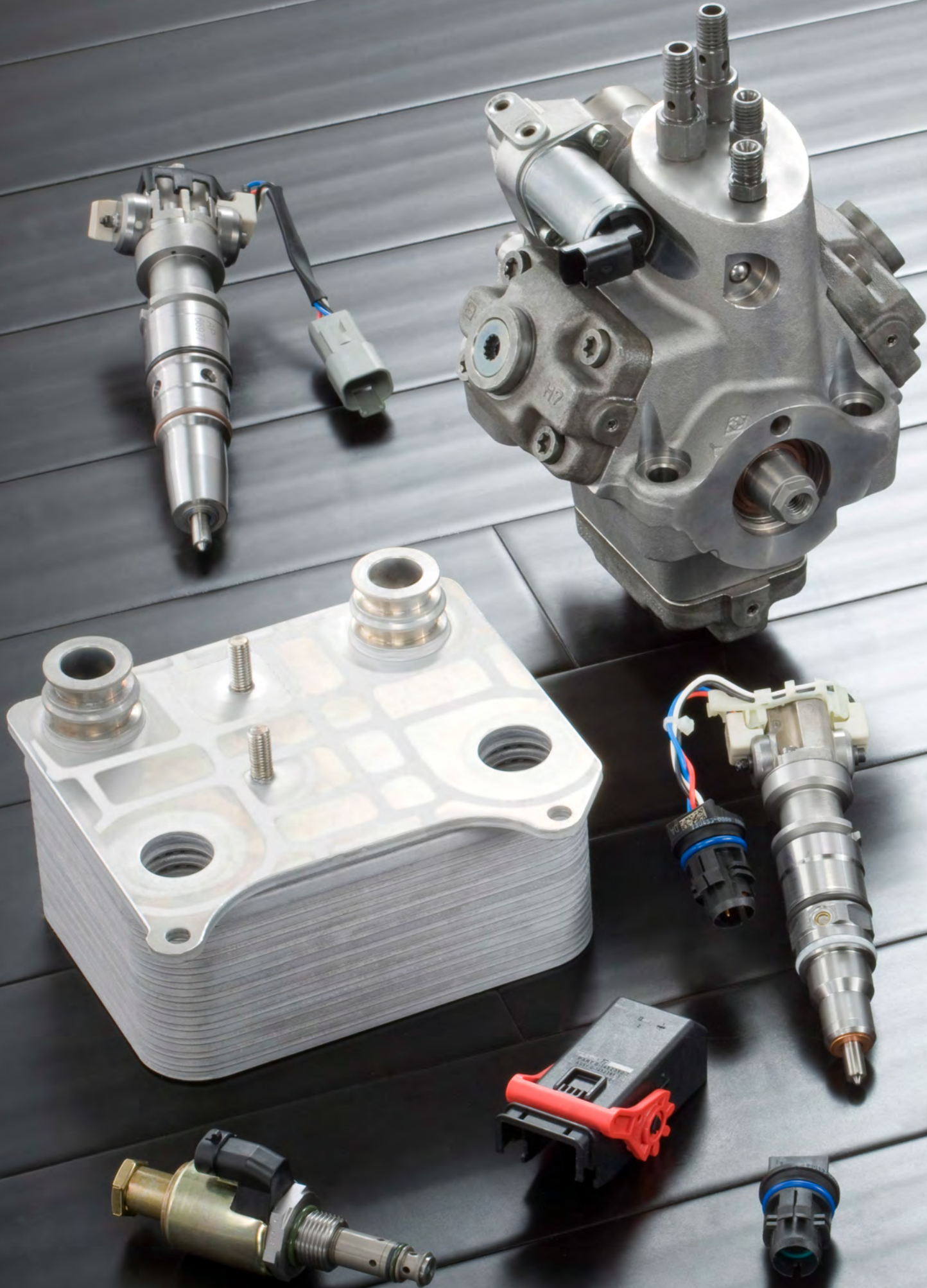

FORD



7.3 L POWER STROKE

Injectors

AP63800AA



HEUI Injector*

OEM Part Numbers: F81Z9E527DRM, F4TZ9VE527AARM, F7TZ9E527ARM

Year Range:	Application:
1994–1998	F Series
1994–1996	F Series (California)
1994–1996	E Series

AP63801AB



HEUI Injector*

OEM Part Numbers: F81Z9E527BRM, F7TZ9E527BRM, F61Z9VE527BRM

Notes: Prime (Split Shot) Injector. Engines built BEFORE 12/07/1998.

Year Range:	Application:
1999	F Series
1997–1999	F Series (California)
1997–1998	E Series

AP63803AD

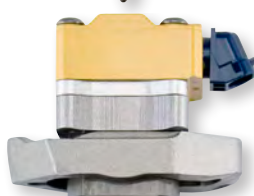

HEUI Injector*

OEM Part Numbers: F81Z9E527CRM, 5C3Z9VE527BRM

Notes: Prime (Split Shot) Injector. Engines built AFTER 12/07/1998.

Year Range:	Application:
1999–2003	F Series, E Series

AP63804AE



HEUI Injector*

OEM Part Numbers: F81Z9E527EARM, XC3Z9E527AARM, F61Z9VE527ERM, 5C3Z9VE527ARM

Notes: Long Lead (LL or blue harness connector) Injector. Engines built AFTER 12/07/1998. Used in #8 cylinder to eliminate "cackle" (Per Ford Bulletins 00–10–1, 00–22–1, and 01–14–6).

Year Range:	Application:	ESN Range:
1999–2003	F Series	661,496 to 896,812
1999–2003	E Series	661,974 to 896,812

Modules

AP63406



Glow Plug Control Module (GPCM)

OEM Part Numbers: YC3Z12B533AA, DY876

Notes: Field data indicates Glow Plug Control Modules (GPCMs) were used on some 2000 to 2003 vehicles.

Year Range:	Application:
2000–2003	F–250 / F–550, Excursion, E Series

* Indicates products with a core charge.

7.3 L POWER STROKE

Modules *continued*

Remanufactured Injector Drive Module (IDM)*

OEM Part Number: F7TZ12B599AC

Year Range: 1994½–1998
Application: F Series, E Series

AP65110

Remanufactured Injector Drive Module (IDM)*

OEM Part Number: XC3Z12B599AA

Year Range: 1999–2003
Application: F Series, Excursion, E Series

AP65120



Fuel System Components

Fuel Transfer Pump—Mechanical

OEM Part Numbers: F6TZ9350A, YC3Z9350CA

Notes: Includes two banjo gaskets.

Year Range: 1994–1998
Application: F Series, E Series

APM61067

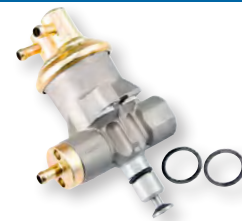

Fuel Transfer Pump—Electronic (Bosch)

OEM Part Numbers: F81Z9C407AC, 0 580 464 074

Year Range: 1999–2003
Application: F Series, Excursion, E Series

69136



Fuel Filter Heater Element

OEM Part Number: F5TZ9J294A

Notes: Field data indicates both elements (AP63409 and AP63410) were used for MY 1998 vehicles. Be sure to verify which element is in place.

Year Range: 1994–1998
Application: F Series, E Series

AP63409



Fuel Filter Heater Element

OEM Part Number: F81Z9J294AA

Notes: Field data indicates both elements (AP63409 and AP63410) were used for MY 1998 vehicles. Be sure to verify which element is in place.

Year Range: 1998–2003
Application: F Series, Excursion, E Series

AP63410



7.3 L POWER STROKE

Engine Components

AP63404



Exhaust Back Pressure (EBP) Tube

OEM Part Number: 1C3Z9D477AA

Year Range:
1999½–2003

Application:
F Series, Excursion, E Series

AP63411



HEUI Injector Sleeve-Brass

OEM Part Number: F4TZ9F538A

Year Range:
1994–2003

Application:
F Series, Excursion, E Series

AP63452

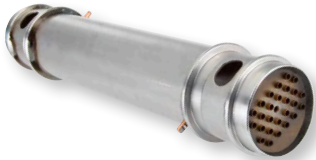

Engine Oil Cooler

OEM Part Number: 1C3Z6A642AA

Notes: Requires AP0004 Engine Oil Cooler O-ring and Gasket Kit for installation.

Year Range:
1994–2003

Application:
F Series, Excursion, E Series

AP63501

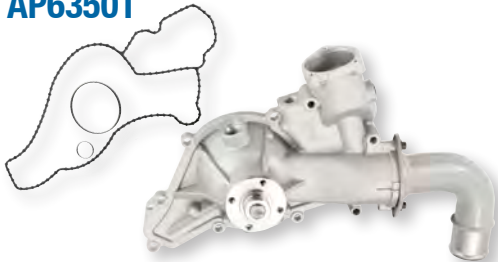

Water Pump

OEM Part Numbers: F81Z8501CRM / ARM, F6TZ8501AARM, 2C3Z8V501BA

Notes: Includes mounting gasket. May require heater hose adapter fitting for installation. See Technical Bulletin APTB 04/06.

Year Range:
1994–1995
1996–2003

Application:
F Series, E Series
F Series, Excursion, E Series

HP004X



Remanufactured High-Pressure Oil Pump (Bosch)

OEM Part Number: F4TZ9A543BRM

Notes: Includes mounting gasket.

Year Range:
1994–1995

Application:
F Series, E Series

HP005X

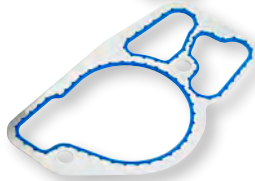

Remanufactured High-Pressure Oil Pump (Bosch)

OEM Part Number: F6TZ9A543ARM

Notes: Includes mounting gasket.

Year Range:
1996–1997

Application:
F Series, E Series

7.3 L POWER STROKE

Engine Components *continued*

Remanufactured High-Pressure Oil Pump (Bosch)

OEM Part Number: F81Z9A543BRM

Notes: Includes mounting gasket.

Year Range:
1998–1999½

Application:
F Series, E Series



HP007X

Remanufactured High-Pressure Oil Pump (Bosch)

OEM Part Number: F81Z9A543CRM

Notes: Includes mounting gasket.

Year Range:
1999½–2003

Application:
F Series, Excursion, E Series



HP008X

Sensors

Camshaft Position (CMP) Sensor

OEM Part Numbers: F7TZ12K073A / B

Year Range:
1997–2003
2000–2003
2000–2003
1997–2003

Application:
F–250 / F–550
F–650 / F–750
Excursion
E Series

ESN Range:
375,549 to 2,030,402
1,026,248 to End
896,813 to 2,030,402
375,549 to 2,030,402



AP63400

Engine Oil Pressure (EOP) Sensor

OEM Part Numbers: F81Z9278AA, SW5267

Year Range:
1994–2003

Application:
F Series, Excursion, E Series



AP63435

Engine Oil Temperature (EOT) Sensor

OEM Part Numbers: F5AZ12A648AB, DY961, DY1144

Year Range:
1994–2003

Application:
F Series, Excursion, E Series

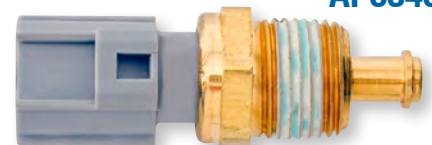

AP63436

7.3 L POWER STROKE

Sensors *continued*

AP63429

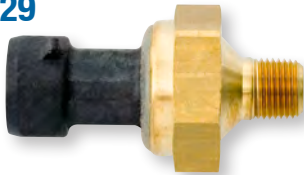

Exhaust Back Pressure (EBP) Sensor

OEM Part Numbers: 1C3Z9J460AA, DPFE1

Year Range:
1994–1997

Application:
F Series, E Series

AP63403

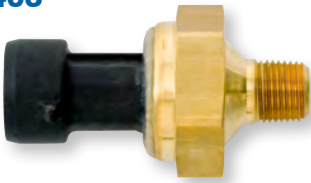

Exhaust Back Pressure (EBP) Sensor

OEM Part Numbers: 4C3Z9J460A, DPFE3

Year Range:
1997–2002
2000–2002
2000–2002
1995–2003

Application:
F–250 / F–550
F–650 / F–750
Excursion
E Series

ESN Range:
501 to 2,030,402
1,026,248 to End
896,813 to 2,030,402
35,651 to 2,030,402

AP63418

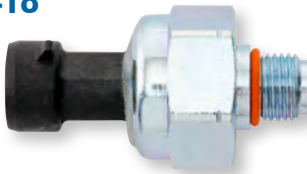

Injection Control Pressure (ICP) Sensor

OEM Part Number: F6TZ9F838A

Year Range:
1999–2002
2000–2002
2000–2002
1995–2003

Application:
F–250 / F–550
F–650 / F–750
Excursion
E Series

ESN Range:
661,974 to 2,030,402
1,026,248 to End
896,813 to 2,030,402
35,651 to 2,030,402

Actuators

AP63401



Injection Pressure Regulator (IPR) Valve

OEM Part Numbers: F4TZ9C968C / CB, 2C3Z9C968BA

Notes: With edge filter.

Year Range:
1994–1995½

Application:
F Series, E Series

ESN Range:
0 to 187,099

AP63402



Injection Pressure Regulator (IPR) Valve

OEM Part Numbers: F81Z9C968AA / AB

Notes: Without edge filter.

Year Range:
1995½–2003

Application:
F Series, Excursion, E Series

ESN Range:
187,100 to End

AP63405



Glow Plug Relay

OEM Part Numbers: F81Z12B533AC, F7TZ12B533A / CA, DY861

Year Range:
1994–2003
2000–2002
2000–2002
1995–2003

Application:
F–250 / F–550
F–650 / F–750
Excursion
E Series

7.3 L POWER STROKE

Electrical Harness and Repair

Valve Cover Harness Connector Repair Kit

Notes: Repairs AP0016 Valve Cover Gasket Connector Pigtail.

Year Range:
1998–2003

Application:
F Series, Excursion, E Series

AP0009



Valve Cover Harness Connector Repair Kit

Notes: Repairs AP0015 Valve Cover Gasket Connector Pigtail.

Year Range:
1994–1997

Application:
F Series, E Series

AP0010



Valve Cover Gasket Connector Pigtail

Year Range:
1994–1997

Application:
F Series, E Series

AP0015



Valve Cover Gasket Connector Pigtail

Year Range:
1998–2003

Application:
F Series, Excursion, E Series

AP0016

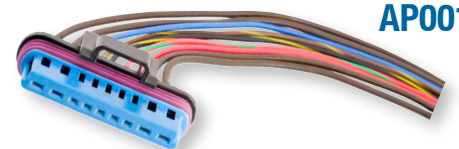

Injection Control Pressure/Exhaust Back Pressure (ICP/EBP) Sensor Connector Pigtail

OEM Part Number: 5C3Z12224A

Notes: Fits AP63418 Injection Control Pressure (ICP) Sensor as well as AP63403 and AP63429 Exhaust Back Pressure (EBP) Sensors.

Year Range:
1994–2003

Application:
F Series, Excursion, E Series

AP0021



2 Wire Pigtail

Notes: Fits AP63401 and AP63402 Injection Pressure Regulator (IPR) Valves and all HEUI A Injectors.

Year Range:
1994–1995½
1995½–2003

Application:
F Series, E Series
F Series, Excursion, E Series

ESN Range:
0 to 187,099
187,100 to End

AP0068



7.3 L POWER STROKE

Electrical Harness and Repair *continued*

AP63413



Internal Injector Harness

OEM Part Number: F81Z9D930AB

Notes: Use with AP0014 Valve Cover Gasket Kit.

Year Range:
1998–2003

Application:
F Series, Excursion, E Series

AP63414



Internal Injector Harness

OEM Part Number: F4TZ9D930K

Notes: Use with AP0013 Valve Cover Gasket Kit.

Year Range:
1994–1997

Application:
F Series, E Series

Seal and Gasket Kits

AP0001



HEUI Injector Seal Kit

OEM Part Number: F8TZ9229AA

Year Range:
1994–2003

Application:
F Series, Excursion, E Series

AP0003

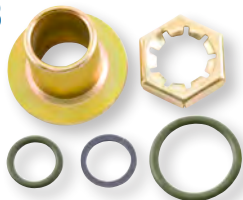

Injection Pressure Regulator (IPR) Valve Seal Kit

OEM Part Number: F6TZ9C977AN

Year Range:
1994–2003

Application:
F Series, Excursion, E Series

AP0004

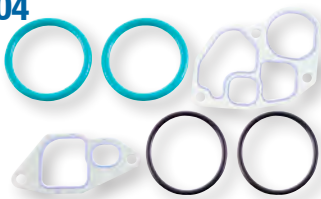

Engine Oil Cooler O-ring and Gasket Kit

OEM Part Numbers: F4TZ6A636A, F7TZ6A636AAA, 1C3Z6C610BA, 1C3Z6K649BA

Year Range:
1994–2003

Application:
F Series, Excursion, E Series

AP0008



Fuel Filter Drain Valve Kit

OEM Part Numbers: F6TZ9157BA and F5TZ9151A

Year Range:
1994–1997

Application:
F Series, E Series

7.3 L POWER STROKE

Seal and Gasket Kits *continued*

Fuel Filter Drain Valve Kit

OEM Part Number: F81Z9C065AA

Notes: Includes grommets.

Year Range:
1998–2003

Application:
F Series, Excursion, E Series



High-Pressure Oil Pump Seal Kit

OEM Part Number: 2C3Z9G804AB

Year Range:
1994–2003

Application:
F Series, Excursion, E Series



Valve Cover Gasket Kit

OEM Part Number: F4TZ6584A

Notes: Use with AP63414 Internal Injector Harness. Package of two.

Year Range:
1994–1997

Application:
F Series, E Series

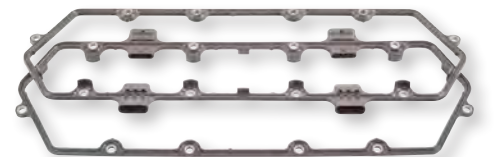

Valve Cover Gasket Kit

OEM Part Number: F81Z6584AA

Notes: Use with AP63413 Internal Injector Harness. Package of two.

Year Range:
1998–2003

Application:
F Series, Excursion, E Series

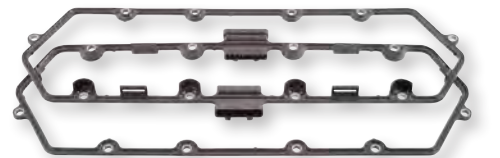

Turbo Installation Kit

OEM Part Number: F81Z6N653BA

Year Range:
1999–2003

Application:
F Series, Excursion, E Series

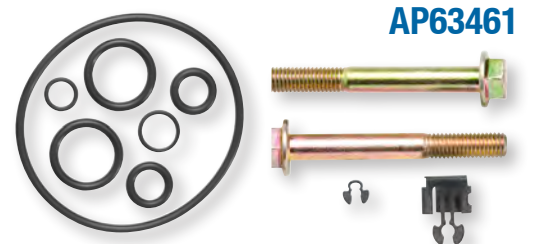

Engine Accessories

Belt Tensioner

OEM Part Numbers: F8UZ6B209CA, BT50

Year Range:
1998–2003
2000–2003

Application:
F Series, E Series
Excursion



7.3 L POWER STROKE

Engine Accessories *continued*

AP63433



Vacuum Pump–Electronic

OEM Part Numbers: 6C3Z2A451A, 6C3A2A451BA, F81Z2A451BA, 4C3Z2A451BA, BRPV-7

Year Range:
1998–2003

Application:
F Series, Excursion, E Series

AP63700



Vacuum Pump–Mechanical

OEM Part Numbers: F6TZ2A451AA, BRPV-6

Year Range:
1998–2002
2000–2002
1996–2002
2002

Application:
F-250 / F-450
F-550
E-350
E-450 / E-550

AP83000



Starter

OEM Part Numbers: F4TZ11002A, F5TU11000AA / AB / AD

Year Range:
1994–2003

Application:
F Series, Excursion, E Series

Filters

PFF829B



Spin–on Fuel Filter/Water Separator (Racor)

OEM Part Number: FD3375

Notes: Only fits 7.3 L IDI Diesel.

Year Range:
1988–1994

Application:
F Series, E Series

PFRK20567



Fuel Filter Bowl/Drain Assembly (Racor)

Notes: Use with PFF829B Spin–on Fuel Filter/Water Separator (Racor). Only fits 7.3 L IDI Diesel.

Year Range:
1988–1994

Application:
F Series, E Series

PFF4595



Fuel Filter Element Service Kit (Racor)

OEM Part Number: FD4495

Year Range:
1994–1998

Application:
F Series, E Series

7.3 L POWER STROKE

Filters *continued*

Fuel Filter Top Cover (Racor)

Year Range:
1994–1998

Application:
F Series, E Series



RK31019

Fuel Filter Element Service Kit (Racor)

OEM Part Number: FD4596

Year Range:
1998½–2003

Application:
F Series, Excursion, E Series



PFF4596

Fuel Filter Top Cover (Racor)

Year Range:
1998½–2003

Application:
F Series, Excursion, E Series



RK31449

Fuel Filter Housing Assembly

OEM Part Numbers: F6TZ9155AB, FG1054

Notes: Includes PFF4595 Fuel Filter Element Service Kit (Racor), RK31019 Fuel Filter Top Cover (Racor), and AP63409 Fuel Filter Heater Element. Field data indicates both housings (AP63424 and AP63425) were used for MY 1998 vehicles. Be sure to verify which housing is in place.

Year Range:
1994–1998

Application:
F Series



AP63424

Fuel Filter Housing Assembly

OEM Part Numbers: F81Z9155AC, FG1057

Notes: Includes PFF4596 Fuel Filter Element Service Kit (Racor), RK31449 Fuel Filter Top Cover (Racor), and AP63410 Fuel Filter Heater Element. Field data indicates both housings (AP63424 and AP63425) were used for MY 1998 vehicles. Be sure to verify which housing is in place.

Year Range:
1998½–2003

Application:
F Series, Excursion, E Series



AP63425

6.0 L AND 4.5 L POWER STROKE

Injectors

AP60900



Remanufactured G2.8 Injector*

OEM Part Numbers: 3C3Z9E527EBRM / EARM / AE / ABRM / ECRM

Notes: Engines built BEFORE 09/22/2003.

Year Range:
 2003–09/21/2003 F–250 / F–550, Excursion
 2003–09/21/2003 F–250 / F–550, Excursion
 2003–09/21/2003 F–650 / F–750

ESN Range:
 0 to 137,745 (Alabama built)
 6,000,000 to 6,155,636 (Indiana built)
 0 to 112,360 (Alabama built)

AP60901



U.S. Patent No.
8,756,813

Remanufactured G2.8 Injector*

OEM Part Numbers: 4C3Z9E527AA / BRM

Notes: Engines built ON or AFTER 09/22/2003.

Year Range:
 09/22/2003–2007 F–250 / F–550, Excursion
 2005–2007 F–650 / F–750
 2004–2010 E Series
 2006–2010 4.5 L LCF

Modules

AP63406



Glow Plug Control Module (GPCM)

OEM Part Numbers: YC3Z12B533AA, DY876

Year Range:
 2003–2007 F–250 / F–550, Excursion
 2004–2010 E Series

* Indicates products with a core charge.

6.0 L AND 4.5 L POWER STROKE

Modules *continued*

Remanufactured Fuel Injection Control Module (FICM)*

OEM Part Numbers: 4C3Z12B599ABRM / AB

Notes: Pre-programmed. Engines built BEFORE 09/22/2003.

Year Range: 2003–09/21/2003
Application: F–250 / F–550, Excursion

Remanufactured Fuel Injection Control Module (FICM)*

OEM Part Numbers: 4C3Z12B599ABRM / AB

Notes: Pre-programmed. Engines built ON or AFTER 09/22/2003.

Year Range: 09/22/2003–2004
Application: F–250 / F–550
 09/22/2003–01/31/2005
Application: Excursion

Remanufactured Fuel Injection Control Module (FICM)*

OEM Part Numbers: 4C3Z12B599ABRM / AB

Notes: Pre-programmed.

Year Range: 2005–2007
Application: F–250 / F–550
 02/01/2005–2005
Application: Excursion
 2004–2010
Application: E Series



AP65122

AP65123

AP65124

Engine Components

Oil Cooler/Exhaust Gas Recirculation (EGR) Cooler Kit

Notes: Includes AP63451 Engine Oil Cooler Kit and AP63446 Exhaust Gas Recirculation (EGR) Cooler Kit.

Year Range: 2004–2007
Application: F Series, Excursion
 2004–2010
Application: E Series

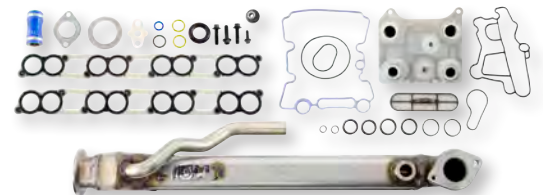

AP63445

Exhaust Gas Recirculation (EGR) Cooler Kit

OEM Part Numbers: 4C3Z9P456AF / AC / AH / AJ

Notes: Includes AP63447 Exhaust Gas Recirculation (EGR) Cooler Intake Gasket Kit.

Year Range: 2004–2007
Application: F Series, Excursion
 2004–2010
Application: E Series

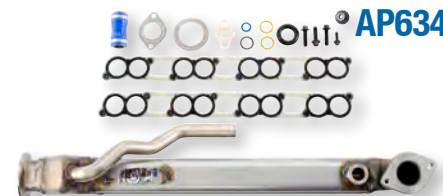

AP63446

6.0 L AND 4.5 L POWER STROKE

Engine Components *continued*

AP63451

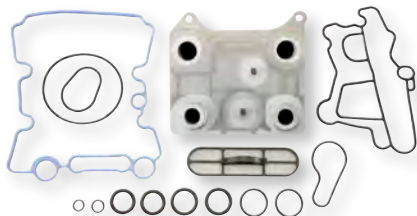

Engine Oil Cooler Kit

OEM Part Number: 3C3Z6A642CA

Notes: Includes AP0039 Engine Oil Cooler Gasket Kit.

Year Range:

2003–2007

2004–2010

2006–2010

Application:

F Series, Excursion

E Series

4.5 L LCF

AP63454

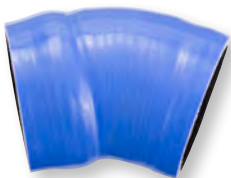

Turbo Hose–Short

OEM Part Number: 6C3Z6C640A

Year Range:

2003–2004

Application:

F Series, Excursion

AP63455



Turbo Hose–Long

OEM Part Number: 6C3Z6C640C

Year Range:

2004½–2007

Application:

F Series, Excursion

AP63502

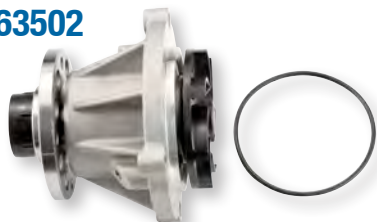

Water Pump

OEM Part Numbers: 3C3Z8501A, PW480

Notes: Includes mounting gasket. F–650 / F–750 use AP63583 Water Pump Navistar VT365.

Year Range:

2003–07/19/2004

2004–07/19/2004

Application:

F–250 / F–550, Excursion

E Series

AP63503

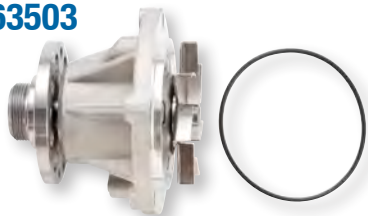

Water Pump

OEM Part Numbers: 4C3Z8501AC, PW491

Notes: Includes mounting gasket. F–650 / F–750 use AP63583 Water Pump Navistar VT365.

Year Range:

07/20/2004–2007

07/20/2004–2010

2006–2010

Application:

F–250 / F–550, Excursion

E Series

4.5 L LCF

6.0 L AND 4.5 L POWER STROKE

Engine Components *continued*

Remanufactured High-Pressure Oil Pump*

OEM Part Numbers: 5C4Z9A543A / B, 5C3Z9A543C, 5C3Z9A543ARM

Notes: Includes seal kit.

Year Range:
2004½–2007
2004½–2010

Application:
F Series, Excursion
E Series



AP63661

Remanufactured High-Pressure Oil Pump*

OEM Part Number: 6E7Z9A543BRM

Year Range:
2006–2007

Application:
4.5 L LCF

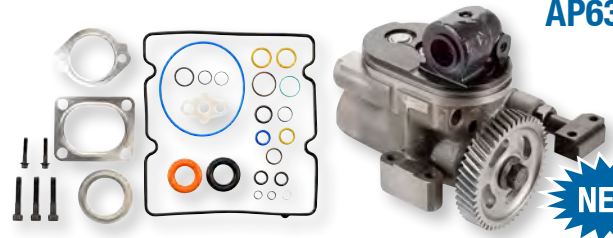

AP63662

Remanufactured High-Pressure Oil Pump*

OEM Part Number: 8E7Z9A543CRM

Year Range:
2008–2010

Application:
4.5 L LCF

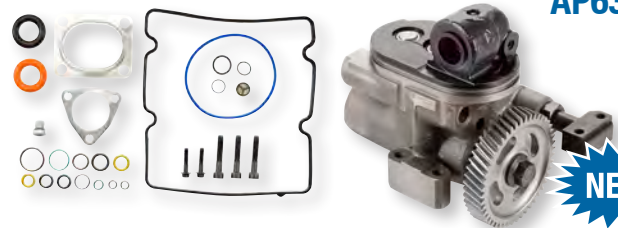

AP63663

Remanufactured High-Pressure Oil Pump (Bosch)

OEM Part Numbers: 3C3Z9A543AARM, 4C3Z9A543AARM

Notes: Includes seal kit.

Year Range:
2003–2004

Application:
F Series, Excursion



HP032X

* Indicates products with a core charge.

6.0 L AND 4.5 L POWER STROKE

Sensors

AP63412



Crankshaft Position (CKP) Sensor

OEM Part Numbers: 3C3Z6C315AA, DY985

Year Range:	Application:
2003–2007	F Series, Excursion
2004–2010	E Series
2006–2010	4.5 L LCF

AP63415



Camshaft Position (CMP) Sensor

OEM Part Numbers: 3C3Z12K073AA, 8C3Z12K073A, DU88

Year Range:	Application:
2003–2007	F Series, Excursion
2004–2010	E Series
2006–2010	4.5 L LCF

AP63435



Engine Oil Pressure (EOP) Sensor

OEM Part Numbers: F81Z9278AA, SW5267

Year Range:	Application:
2003–2007	F Series, Excursion
2004–2010	E Series
2006–2010	4.5 L LCF

AP63437

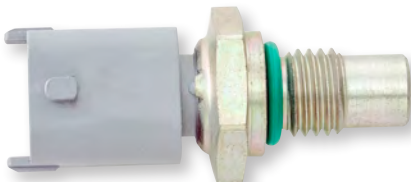

Engine Oil/Coolant/Fuel Temperature (EOT/ECT/FT) Sensor

OEM Part Numbers: 3C3Z10884AA, SW6052

Year Range:	Application:
2003–2007	F Series, Excursion
2004–2010	E Series
2006–2010	4.5 L LCF

AP63403

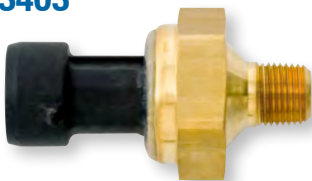

Exhaust Back Pressure (EBP) Sensor

OEM Part Numbers: 4C3Z9J460A, DPFE3

Year Range:	Application:	ESN Range:
2003–2004	F Series, Excursion	6,000,000 to 6,344,942
2004	E Series	0 to 149,760

AP63408



Exhaust Back Pressure (EBP) Sensor

OEM Part Numbers: 5C3Z9J460A / B, DPFE6

Year Range:	Application:	ESN Range:
2005–2007	F–250 / F–550, Excursion	6,344,943 to End
2003–2007	F–650 / F–750	
2004–2010	E Series	149,761 to End

6.0 L AND 4.5 L POWER STROKE

Sensors *continued*

Injection Control Pressure (ICP) Sensor

OEM Part Number: 3C3Z9F838EA

Notes: Mounts below turbo.

Year Range:
2003–2004

Application:
F Series, Excursion

AP63407



Injection Control Pressure (ICP) Sensor

OEM Part Numbers: 4C3Z9F838A / AB

Notes: Mounts on passenger side valve cover.

Year Range:
2004–2007
2004–2010
2006–2010

Application:
F Series, Excursion
E Series
4.5 L LCF

AP63460

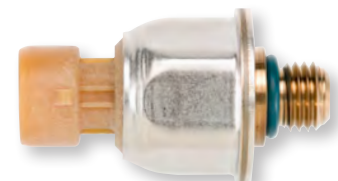

Intake Manifold Air Temperature (IAT) Sensor

OEM Part Numbers: 3C3Z12A697AA, DY984

Year Range:
2003–2010
2006

Application:
F Series, Excursion, E Series
4.5 L LCF

AP63462

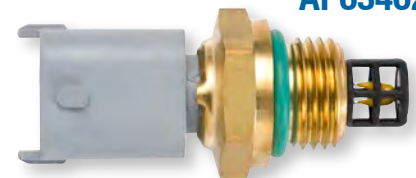

Intake Manifold Air Temperature (IAT) Sensor

OEM Part Numbers: 8C3Z12A697B, DY1112

Year Range:
2007–2010

Application:
4.5 L LCF

AP63463

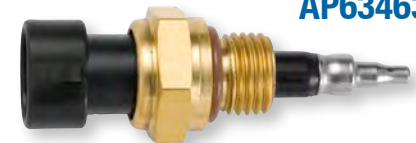

**Visit alliantpower.com
to Find Your Nearest
Service Dealer**

6.0 L AND 4.5 L POWER STROKE

Actuators

AP63416



Injection Pressure Regulator (IPR) Valve

OEM Part Numbers: 3C3Z9C968AA, CM5054

Notes: Without edge filter.

Year Range:
2003–2004

Application:
F Series, Excursion

AP63417



Injection Pressure Regulator (IPR) Valve

OEM Part Numbers: 5C3Z9C968CA, CM5126

Notes: With edge filter.

Year Range:
2005–2007
2004–2010
2006–2010

Application:
F Series, Excursion
E Series
4.5 L LCF

AP63438



Exhaust Gas Recirculation (EGR) Valve*

OEM Part Numbers: 4C3Z9F452A, CX2056, CX2467RM

Year Range:
2003–2004

Application:
F Series, Excursion

AP63439



Exhaust Gas Recirculation (EGR) Valve*

OEM Part Numbers: 5C3Z9F452AA, CX2020, CX2466RM

Year Range:
2004½–2007
2004½–2010

Application:
F–250 / F–550, Excursion
E Series

Electrical Harness and Repair

AP0021



Injection Control Pressure/Exhaust Back Pressure (ICP/EBP) Sensor Connector Pigtail

OEM Part Number: 5C3Z12224A

Notes: Fits AP63407 and AP63460 Injection Control Pressure (ICP) Sensors as well as AP63403 and AP63408 Exhaust Back Pressure (EBP) Sensors.

Year Range:
2003–2007
2004–2010
2006–2010

Application:
F Series, Excursion
E Series
4.5 L LCF

* Indicates products with a core charge.

6.0 L AND 4.5 L POWER STROKE

Electrical Harness and Repair *continued*

2 Wire Pigtail

AP0056

Notes: Fits AP63437 Engine Oil/Coolant/Fuel Temperature (EOT/ECT/FT) Sensor.

Year Range:	Application:
2003–2007	F Series, Excursion
2004–2010	E Series
2006–2010	4.5 L LCF



Injector Harness Connector

AP0030

Year Range:	Application:
2003–2007	F Series, Excursion
2004–2010	E Series
2006–2010	4.5 L LCF



G2.8 Injector Connector

AP0040

Notes: See Technical Bulletin APTB 03/14 for installation instructions.

Year Range:	Application:
2003–2007	F Series, Excursion
2004–2010	E Series
2006–2010	4.5 L LCF



Fuel Injection Control Module (FICM) Connector

AP0018

Notes: Field data shows identification marks 1456315–6, 1437287–7, or X–3.

Year Range:	Application:
2003–2007	F Series, Excursion
2004–2010	E Series
2006–2010	4.5 L LCF

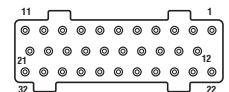

Fuel Injection Control Module (FICM) Connector

AP0019

Notes: Field data shows identification marks 1456315–2, 1437287–6, or X–2.

Year Range:	Application:
2003–2007	F Series, Excursion
2004–2010	E Series
2006–2010	4.5 L LCF

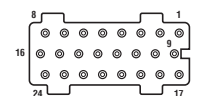

Fuel Injection Control Module (FICM) Connector

AP0020

Notes: Field data shows identification marks 1456316–1, 1437287–5, or X–1.

Year Range:	Application:
2003–2007	F Series, Excursion
2004–2010	E Series
2006–2010	4.5 L LCF

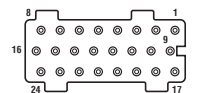

6.0 L AND 4.5 L POWER STROKE

Electrical Harness and Repair *continued*

AP0031



Fuel Injection Control Module (FICM) Connector Pigtail

Notes: Replaces AP0018 Fuel Injection Control Module (FICM) Connector. Field data shows identification marks 1456315-6, 1437287-7, or X-3.

Year Range:
2003-2007
2004-2010

Application:
F Series, Excursion
E Series

AP0032



Fuel Injection Control Module (FICM) Connector Pigtail

Notes: Replaces AP0019 Fuel Injection Control Module (FICM) Connector. Field data shows identification marks 1456315-2, 1437287-6, or X-2.

Year Range:
2003-2007
2004-2010

Application:
F Series, Excursion
E Series

AP0033



Fuel Injection Control Module (FICM) Connector Pigtail

Notes: Replaces AP0020 Fuel Injection Control Module (FICM) Connector. Field data shows identification marks 1456316-1, 1437287-5, or X-1.

Year Range:
2003-2007
2004-2010

Application:
F Series, Excursion
E Series

AP0068



2 Wire Pigtail

Notes: Fits AP63416 and AP63417 Injection Pressure Regulator (IPR) Valves and the VGT Solenoid.

Year Range:
2003-2007
2004-2010
2006-2010

Application:
F Series, Excursion
E Series
4.5 L LCF

Seal and Gasket Kits

AP0002



G2.8 Injector Seal Kit

OEM Part Numbers: 3C3Z9229AA, CM5055

Notes: Includes high-pressure oil seal.

Year Range:
2003-2007
2004-2010
2006-2010

Application:
F Series, Excursion
E Series
4.5 L LCF

6.0 L AND 4.5 L POWER STROKE

Seal and Gasket Kits *continued*

Exhaust Gas Recirculation (EGR) Valve O-ring Kit

OEM Part Number: 3C3Z9P455AB

Year Range: 2003–2007
2004–2010

Application: F Series, Excursion
E Series



AP0005

Valve Cover Gasket

OEM Part Number: 3C3Z6584BA

Year Range: 2003–2007
2004–2010

Application: F Series, Excursion
E Series

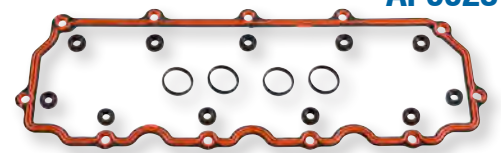

AP0023

Stand Pipe and Front Port Plug Seal Kit

OEM Part Numbers: W302209, W301386, and W301390

Notes: Reseals one side.

Year Range: 2003–2007
2004–2010
2006–2010

Application: F Series, Excursion
E Series
4.5 L LCF



AP0028

Injection Pressure Regulator (IPR) Valve Seal Kit

OEM Part Number: 3C3Z9H529A

Year Range: 2003–2007
2004–2010
2006–2010

Application: F Series, Excursion
E Series
4.5 L LCF



AP0035

Engine Oil Cooler Gasket Kit

Year Range: 2003–2007
2004–2010
2006–2010

Application: F Series, Excursion
E Series
4.5 L LCF

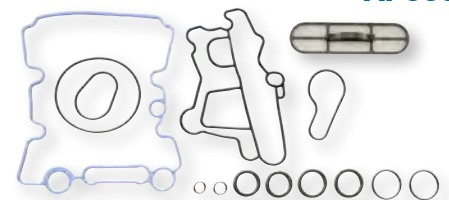

AP0039

6.0 L AND 4.5 L POWER STROKE

Seal and Gasket Kits *continued*

AP0043

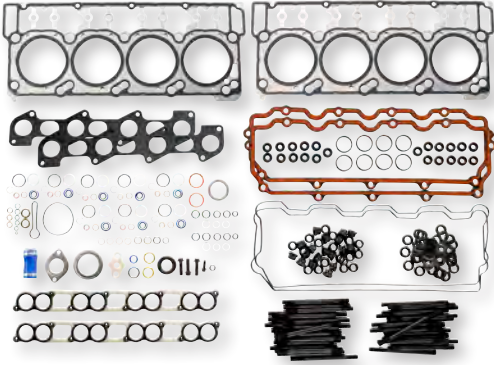

Head Gasket Kit

Notes: 18 mm dowels.

Year Range:

2003–2006
2004–2006

Application:

F Series, Excursion
E Series

Kit Contents:

- 2 Cylinder Head Gaskets with 18 mm Dowels
- 2 Exhaust Manifold Gaskets
- 2 Rocker Housing Gaskets
- 1 Secondary Fuel Filter Seal Kit
- 4 Fuel Inlet Copper Washers
- 2 Valve Cover Gaskets
- 8 Injector Seal Kits
- 1 Exhaust Gas Recirculation (EGR) Cooler Intake Gasket Kit
- 1 Exhaust Gas Recirculation (EGR) Valve O-ring Kit
- 1 Head Stud Kit
- 2 Stand Pipe and Front Port Plug Seal Kits

AP0044

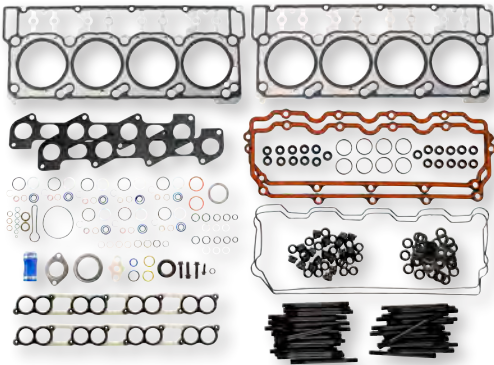

Head Gasket Kit

Notes: 20 mm dowels.

Year Range:

2006–2007
2006–2010

Application:

F Series, Excursion
E Series

Kit Contents:

- 2 Cylinder Head Gaskets with 20 mm Dowels
- 2 Exhaust Manifold Gaskets
- 2 Rocker Housing Gaskets
- 1 Secondary Fuel Filter Seal Kit
- 4 Fuel Inlet Copper Washers
- 2 Valve Cover Gaskets
- 8 Injector Seal Kits
- 1 Exhaust Gas Recirculation (EGR) Cooler Intake Gasket Kit
- 1 Exhaust Gas Recirculation (EGR) Valve O-ring Kit
- 1 Head Stud Kit
- 2 Stand Pipe and Front Port Plug Seal Kits

AP0070



High-Pressure Oil Rail Seal Kit

Notes: AP0069 High-Pressure Oil Rail Socket required for installation.

Year Range:

2003–2007
2004–2010
2006–2010

Application:

F Series, Excursion
E Series
4.5 L LCF

6.0 L AND 4.5 L POWER STROKE

Seal and Gasket Kits *continued*

Exhaust Gas Recirculation (EGR) Cooler Intake Gasket Kit

AP63447

OEM Part Number: 3C3Z9433BE

Year Range:
2003–2007
2004–2010

Application:
F Series, Excursion
E Series



Engine Accessories

Fan Clutch

AP63430

OEM Part Numbers: 4C3Z8A616AA, YB632

Year Range:
2003–2007
2004–2010

Application:
F–250 / F–550, Excursion
E Series



Belt Tensioner

AP63432

OEM Part Number: 3C2Z6B209BA

Notes: Dual alternator configurations.

Year Range:
2003–2007
2004–2010

Application:
F–250 / F–550, Excursion
E Series



Belt Tensioner

AP63448

OEM Part Number: 3C2Z6B209AA

Year Range:
2003–2007
2004–2010

Application:
F–250 / F–550, Excursion
E Series



Vacuum Pump–Electronic

AP63433

OEM Part Numbers: 6C3Z2A451A, 6C3A2A451BA, F81Z2A451BA, 4C3Z2A451BA, BRPV–7

Year Range:
2003–2007

Application:
F–250 / F–550, Excursion



Vacuum Pump–Mechanical

AP63703

OEM Part Numbers: 4C2Z2A451AA, BRPV–1

Year Range:
2004–2010

Application:
E Series



6.0 L AND 4.5 L POWER STROKE

Engine Accessories *continued*

AP83006



Starter

OEM Part Numbers: 3C3Z11002AA, 3C3U11000AB

Year Range:
2003–2007
2004–2010

Application:
F–250 / F–550, Excursion
E Series

Filters

AP63426



Horizontal Fuel Conditioning Module (HFCM)

OEM Part Numbers: 3C3Z9C407AB, 6C3Z9C407AA, 6C3Z9G282AA, PFB93, PFB101

Notes: Field data indicates that some vehicles built BEFORE 09/15/2003 may have three plug connections and would require a new wiring harness (6C3Z9F759A) for installation.

Year Range:
2003–2007

Application:
F–250 / F–550

AP63431



Vertical Fuel Conditioning Module (VFCM)

OEM Part Numbers: 6C2Z9G282AA, PFB98, 9C2Z9G282A, 6C3Z9G282C

Year Range:
2004–2010

Application:
E Series

PFF31795



Fuel Filter Housing Cap (Racor)

OEM Part Number: 3C3Z9G270AA

Year Range:
2003–2007
2004–2010
2006–2010

Application:
F–250 / F–550, Excursion
E Series
4.5 L LCF

PFF4606



Fuel Filter Element Service Kit (Racor)

OEM Part Number: FD4606

Notes: Primary and secondary.

Year Range:
2004–2010

Application:
E Series

6.0 L AND 4.5 L POWER STROKE

Filters continued

Fuel Filter Element Service Kit (Racor)

OEM Part Number: FD4604

Notes: Primary and secondary.

Year Range:	Application:
2003–2007	F–250 / F–550, Excursion
2006–2010	4.5 L LCF



Oil Filter Element Service Kit (Racor)

OEM Part Number: FL2016

Year Range:	Application:
2003–2007	F Series, Excursion
2004–2010	E Series



Oil Filter Cap (Racor)

OEM Part Number: 3C3Z6766CA

Year Range:	Application:
2003–2007	F Series, Excursion
2006–2010	4.5 L LCF



Oil Filter Cap (Racor)

OEM Part Number: 4C2Z6766BA

Year Range:	Application:
2004–2010	E Series



6.4 L POWER STROKE

Injectors

AP64900



Remanufactured Piezo Injector*

OEM Part Numbers: 8C3Z9E527A, 8C3Z9E527DRM

Notes: Includes injection line.

Year Range:
2008–2010

Application:
F–250 / F–550

Modules

AP63406



Glow Plug Control Module (GPCM)

OEM Part Numbers: YC3Z12B533AA, DY876

Year Range:
2008–2010

Application:
F–250 / F–550

Engine Components

AP63472



Coolant Pump

OEM Part Number: 7C3Z8B552A

Year Range:
2008–2010

Application:
F–250 / F–550

AP63504



Water Pump

OEM Part Numbers: 8C3Z8501B, PW482

Notes: Includes mounting gasket.

Year Range:
2008–2010

Application:
F–250 / F–550

* Indicates products with a core charge.

6.4 L POWER STROKE

Engine Components *continued*

Remanufactured High-Pressure Fuel Pump (HPFP) Kit*

OEM Part Numbers: 8C3Z9A543DRM, 8C3Z9A543B

Notes: Includes pump and installation kit.

Year Range:
2008–2010

Application:
F–250 / F–550



AP63640



Sensors

Crankshaft Position (CKP) Sensor

OEM Part Numbers: 3C3Z6C315AA, DY985

Year Range:
2008–2010

Application:
F Series



AP63412

Camshaft Position (CMP) Sensor

OEM Part Numbers: 3C3Z12K073AA, 8C3Z12K073A, DU88

Year Range:
2008–2010

Application:
F Series



AP63415

Fuel Rail Pressure Sensor

OEM Part Number: 8C3Z9G756A

Notes: Includes gasket.

Year Range:
2008–2010

Application:
F Series



AP63422

Exhaust Back Pressure (EBP) Sensor

OEM Part Numbers: 8C3Z9J460A, DPFE8

Year Range:
2008–2010

Application:
F Series

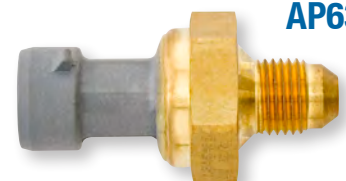

AP63423

6.4 L POWER STROKE

Sensors *continued*

AP63435



Engine Oil Pressure (EOP) Sensor

OEM Part Numbers: F81Z9278AA, SW5267

Year Range:
2008–2010

Application:
F Series

AP63437

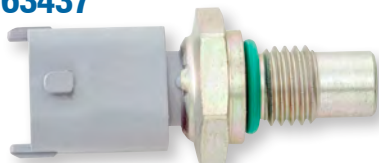

Engine Oil/Coolant/Fuel Temperature (EOT/ECT/FT) Sensor

OEM Part Numbers: 3C3Z10884AA, SW6052

Year Range:
2008–2010

Application:
F Series

AP63463

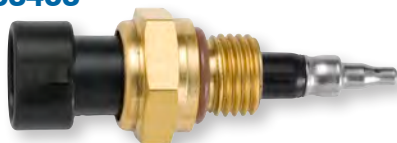

Intake Manifold Air Temperature (IAT) Sensor

OEM Part Numbers: 8C3Z12A697B, DY1112

Year Range:
2008–2010

Application:
F Series

AP63470

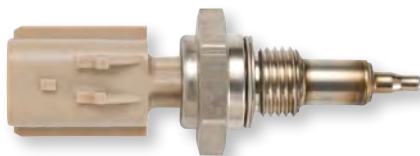

Exhaust Gas Recirculation (EGR) Temperature Sensor–Inlet

OEM Part Number: 8C3Z12B591A

Year Range:
2008–2010

Application:
F Series

AP63471



Exhaust Gas Recirculation (EGR) Temperature Sensor–Outlet

OEM Part Number: 8C3Z12B591E

Year Range:
2008–2010

Application:
F–250 / F–550

AP63473



Diesel Particulate Filter Pressure (DPFP) Sensor

OEM Part Numbers: 8C3Z9J460D, DPFE17

Year Range:
2008–2010

Application:
F–250 / F–550

6.4 L POWER STROKE

Sensors *continued*

Mass Air Flow/Intake Manifold Air Temperature (MAF/IAT) Sensor*

OEM Part Numbers: 7C3Z12B579A, AFLS179

Year Range: 2008–2010
Application: F–250 / F–550



AP63475

Manifold Absolute Pressure (MAP) Sensor

OEM Part Numbers: 8C349F479AA, 8C3Z9F479A, CX2161

Year Range: 2008–2010
Application: F Series

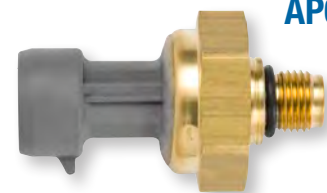

AP63476

Actuators

Exhaust Gas Recirculation (EGR) Valve

OEM Part Number: 8C3Z9D475D

Year Range: 2008–2010
Application: F Series

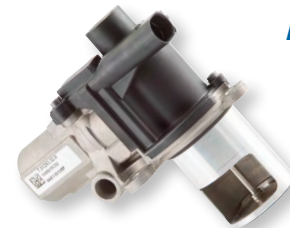

AP63456

Electrical Harness and Repair

Exhaust Back Pressure (EBP) Sensor Connector Pigtail

OEM Part Number: 5C3Z12224A

Notes: Fits AP63423 Exhaust Back Pressure (EBP) Sensor.

Year Range: 2008–2010
Application: F Series



AP0021

2 Wire Pigtail

Notes: Fits AP63437 Engine Oil/Coolant/Fuel Temperature (EOT/ECT/FT) Sensor.

Year Range: 2008–2010
Application: F Series



AP0056

* Indicates products with a core charge.

6.4 L POWER STROKE

Electrical Harness and Repair *continued*

AP0076



Engine Harness Connector Cover

Year Range:
2008–2010

Application:
F Series

Seal and Gasket Kits

AP0027



Injection Line and O-ring Kit

OEM Part Number: 8C3Z9229A

Year Range:
2008–2010

Application:
F Series

AP0042



Exhaust Gas Recirculation (EGR) Valve O-ring

OEM Part Number: 8C3Z9D476A

Year Range:
2008–2010

Application:
F Series

AP0064

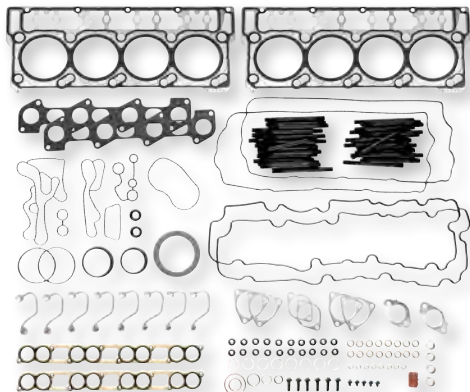

Head Gasket Kit

Year Range:
2008–2010

Application:
F Series

Kit Contents:

- 2 Cylinder Head Gaskets
- 2 Exhaust Manifold Gaskets
- 2 Rocker Housing Gaskets
- 2 Valve Cover Gaskets
- 8 Injector Seal Kits with Injection Lines
- 1 Intake Exhaust Gas Recirculation (EGR) Gasket Kit
- 1 Turbo Gasket Kit
- 1 Oil Cooler Gasket Kit
- 1 Head Stud Kit

6.4 L POWER STROKE

Seal and Gasket Kits *continued*

High-Pressure Fuel Pump (HPFP) Installation Kit

Notes: Installation kit only. If pump is needed see AP63640 Remanufactured High-Pressure Fuel Pump (HPFP) Kit.

Year Range: 2008–2010
Application: F-250 / F-550

AP0071



Engine Accessories

Starter

OEM Part Numbers: 7C3Z11002AA, SA965

Year Range: 2008–2010
Application: F Series

AP83007



Filters

Horizontal Fuel Conditioning Module (HFCM)

OEM Part Numbers: 8C3Z9G282A, PFB95

Year Range: 2008–2010
Application: F-250 / F-550

AP63450



Fuel Filter Element Service Kit (Racor)

OEM Part Numbers: FD4609, PFF5550

Notes: Primary and secondary.

Year Range: 2008–2010
Application: F-250 / F-550

PFF4617



6.4 L POWER STROKE

Filters continued

PFL2016



Oil Filter Element Service Kit (Racor)

OEM Part Number: FL2016

Year Range:
2008–2010

Application:
F Series

RK31821



Oil Filter Cap (Racor)

OEM Part Number: 3C3Z6766CA

Year Range:
2008–2010

Application:
F Series

***For Additional Information
such as OEM Cross Reference
and Product Instructions
Please Visit alliantpower.com***

6.7 L POWER STROKE

Electrical Harness and Repair

2 Wire Pigtail

Notes: Fits the VGT Solenoid.

Year Range:
2011–2012

Application:
F–250 / F–550



AP0068

Filters

Fuel Filter Element Service Kit

OEM Part Number: BC3Z9N184B

Notes: Primary and secondary.

Year Range:
2011–2014

Application:
F–250 / F–550



AP61004

***Visit alliantpower.com
for Additional Information
Such as Technical Bulletins and
New Product Announcements***

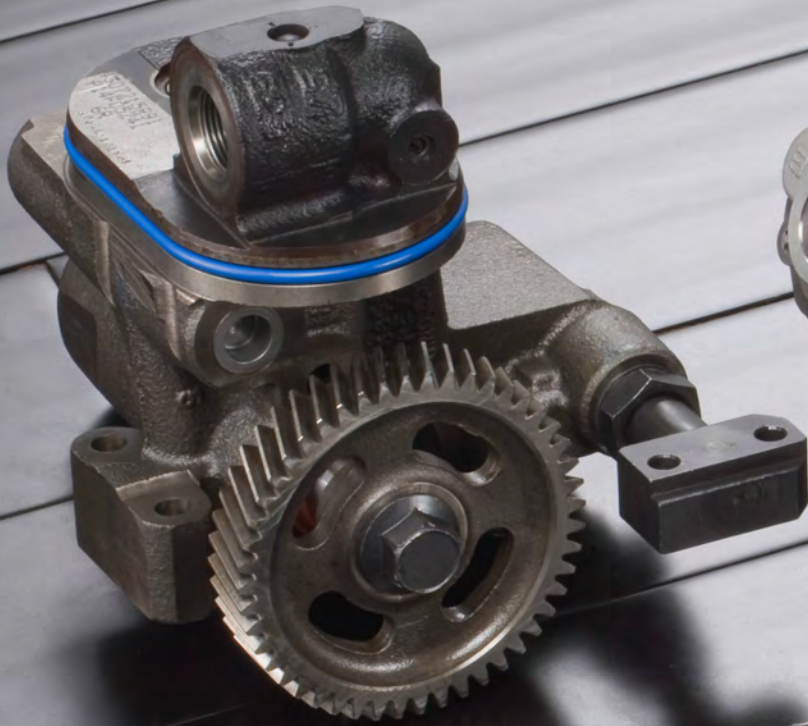

NAVISTAR



T444E

Injectors

AP63800AA



HEUI Injector*

OEM Part Numbers: 1816187C3, 1818259C2, 1821752C1, 1821836C3, 1822800C95, 1822801C91

Year Range: 1994–1996	Application: T444E	ESN Range: 500 to 460,194
---------------------------------	------------------------------	-------------------------------------

AP63801AB



HEUI Injector*

OEM Part Numbers: 1822803C1, 1823561C1, 1824582C94, 1824583C97, 1825125C1, 1825126C1

Notes: Prime (Split Shot) Injector.

Year Range: 1997–1999	Application: T444E	ESN Range: 460,195 to 843,989
---------------------------------	------------------------------	---

AP63802AC



HEUI Injector*

OEM Part Numbers: 1824474C2, 1822890C1, 1824472C1, 1824473C2, 1824455C94, 1824456C96

Year Range: 1994–1996	Application: T444E: High Output 210 HP (HT) to 230 HP
---------------------------------	---

AP63803AD



HEUI Injector*

OEM Part Numbers: 1823751C91, 1831487C92, 1831488C1, 1831489C12, 1831550C14, 1831551C13

Notes: Prime (Split Shot) Injector. Recommend replacing AD Injector in #8 cylinder location with AE Injector to eliminate "cackle." This became standard production in 2002.

Year Range: 1999–2003	Application: T444E	ESN Range: 843,990 to 5,999,999
---------------------------------	------------------------------	---

AP63804AE



HEUI Injector*

OEM Part Numbers: 1833639C1, 1833640C1, 1833644C1, 1833645C1, 1833646C92, 1833647C91

Notes: Long Lead (LL or blue harness connector) Injector. Used in #8 cylinder location to eliminate "cackle."

Year Range: 2002–2003	Application: T444E	ESN Range: 1,313,828 to 5,999,999
---------------------------------	------------------------------	---

* Indicates products with a core charge.

Fuel System Components

Fuel Transfer Pump—Mechanical

OEM Part Numbers: 1824415C93, 1826794C93

Notes: Includes two banjo gaskets.

Year Range: 1994–2003
Application: T444E

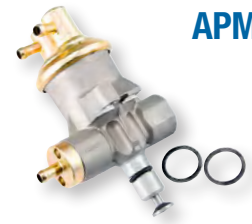

APM61067

Fuel Filter Heater Element

OEM Part Number: 1825186C91

Year Range: 1994–1998
Application: T444E



AP63409

Fuel Filter Heater Element

OEM Part Number: 1831196C92

Year Range: 1999–2003
Application: T444E



AP63410

Engine Components

HEUI Injector Sleeve—Brass

OEM Part Number: 1814376C1

Year Range: 1994–2003
Application: T444E



AP63411

Engine Oil Cooler

OEM Part Number: 1815904C2

Notes: Requires AP0004 Engine Oil Cooler O-ring and Gasket Kit for installation.

Year Range: 1994–2003
Application: T444E



AP63452

Water Pump

OEM Part Numbers: 1831676C92, 1889249C91

Notes: Includes mounting gasket and plugs.

Year Range: 1994–2003
Application: T444E

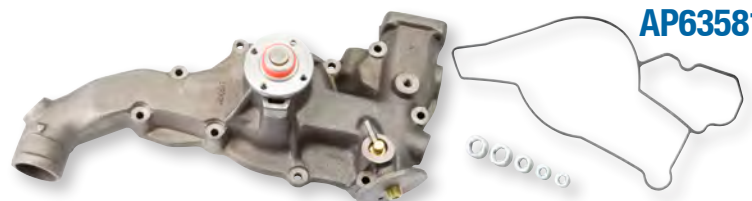

AP63581

T444E

Engine Components *continued*

HP004X



Remanufactured High-Pressure Oil Pump (Bosch)

OEM Part Numbers: 1825247C91, 1825260C91, 1825271C93, 2503701C91

Notes: Includes mounting gasket.

Year Range: See ESN	Application: T444E	ESN Range: 5,500 to 216,543
-------------------------------	------------------------------	---------------------------------------

HP005X



Remanufactured High-Pressure Oil Pump (Bosch)

OEM Part Numbers: 1825248C91, 1825259C91, 2503703C91

Notes: Includes mounting gasket.

Year Range: See ESN	Application: T444E	ESN Range: 216,544 to 661,894
-------------------------------	------------------------------	---

HP007X



Remanufactured High-Pressure Oil Pump (Bosch)

OEM Part Numbers: 1830857C91, 2503704C91

Notes: Includes mounting gasket.

Year Range: See ESN	Application: T444E	ESN Range: 661,895 to 843,989
-------------------------------	------------------------------	---

HP008X



Remanufactured High-Pressure Oil Pump (Bosch)

OEM Part Numbers: 1831449C91, 2589446C91

Notes: Includes mounting gasket.

Year Range: See ESN	Application: T444E	ESN Range: 843,990 to End
-------------------------------	------------------------------	-------------------------------------

Sensors

AP63400

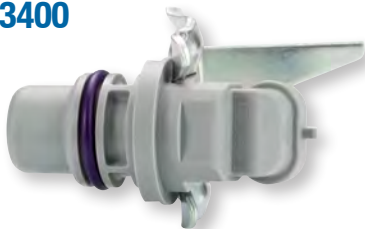

Camshaft Position (CMP) Sensor

OEM Part Numbers: 1825899C93, 1876735C91

Year Range: 1997-2003	Application: T444E
---------------------------------	------------------------------

Sensors continued

Exhaust Back Pressure (EBP) Sensor

OEM Part Number: 1850353C1

Year Range: 1997–2002
Application: T444E

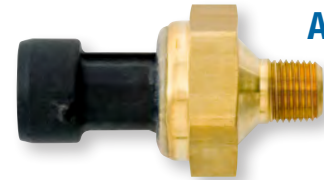

AP63403

Injection Control Pressure (ICP) Sensor

OEM Part Number: 1807329C92

Year Range: 1994–2003
Application: T444E

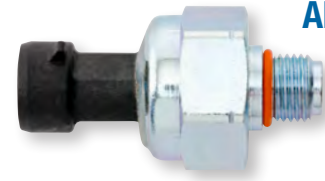

AP63418

Actuators

Injection Pressure Regulator (IPR) Valve

OEM Part Numbers: 1824982C91, 1833798C91, 1841279C91

Notes: With edge filter.

Year Range: See ESN
Application: T444E
ESN Range: 5,500 to 216,543



AP63401

Injection Pressure Regulator (IPR) Valve

OEM Part Numbers: 1829856C91, 1836412C91, 1841086C91, 1841217C91

Notes: Without edge filter.

Year Range: See ESN
Application: T444E
ESN Range: 216,544 to End



AP63402

Glow Plug Relay

OEM Part Numbers: 1826634C94, 1831646C1

Year Range: 1994–2003
Application: T444E



AP63405

T444E

Electrical Harness and Repair

AP0009



Valve Cover Harness Connector Repair Kit

Notes: Repairs AP0016 Valve Cover Gasket Connector Pigtail.

Year Range:
1998–2003

Application:
T444E

AP0010



Valve Cover Harness Connector Repair Kit

Notes: Repairs AP0015 Valve Cover Gasket Connector Pigtail.

Year Range:
1994–1997

Application:
T444E

AP0015



Valve Cover Gasket Connector Pigtail

Year Range:
1994–1997

Application:
T444E

AP0016



Valve Cover Gasket Connector Pigtail

Year Range:
1998–2003

Application:
T444E

AP0021



Injection Control Pressure/Exhaust Back Pressure (ICP/EBP) Sensor Connector Pigtail

Notes: Fits AP63418 Injection Control Pressure (ICP) Sensor and AP63403 Exhaust Back Pressure (EBP) Sensor.

Year Range:
1994–2003

Application:
T444E

AP0068



2 Wire Pigtail

Notes: Fits AP63401 and AP63402 Injection Pressure Regulator (IPR) Valves and all HEUI A Injectors.

Year Range:
1994–2003

Application:
T444E

Electrical Harness and Repair *continued*

Internal Injector Harness

OEM Part Number: 1830844C93

Notes: Use with AP0014 Valve Cover Gasket Kit.

Year Range: 1998–2003
Application: T444E

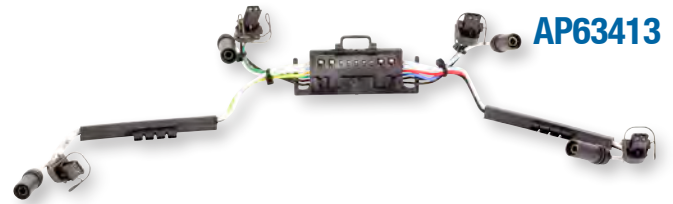

Internal Injector Harness

OEM Part Number: 1815923C92

Notes: Use with AP0013 Valve Cover Gasket Kit.

Year Range: 1994–1997
Application: T444E



Seal and Gasket Kits

HEUI Injector Seal Kit

OEM Part Number: 1833564C92

Year Range: 1994–2003
Application: T444E



Injection Pressure Regulator (IPR) Valve Seal Kit

OEM Part Number: 1825806C91

Year Range: 1994–2003
Application: T444E

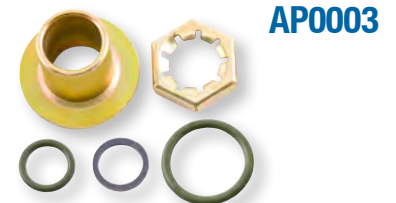

Engine Oil Cooler O-ring and Gasket Kit

Year Range: 1994–2003
Application: T444E

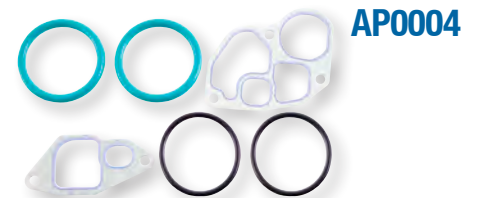

High-Pressure Oil Pump Seal Kit

Year Range: 1994–2003
Application: T444E



T444E

Seal and Gasket Kits *continued*

AP0013

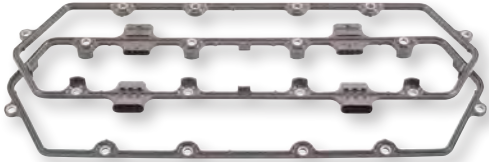

Valve Cover Gasket Kit

OEM Part Number: 1818350C2

Notes: Use with AP63414 Internal Injector Harness. Package of two.

Year Range:
1994–1997

Application:
T444E

AP0014

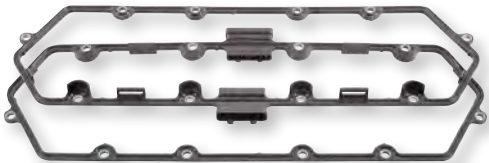

Valve Cover Gasket Kit

OEM Part Number: 1826703C1

Notes: Use with AP63413 Internal Injector Harness. Package of two.

Year Range:
1998–2003

Application:
T444E

AP63461

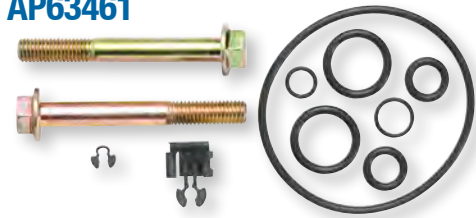

Turbo Installation Kit

OEM Part Number: 1831658C91

Year Range:
1999–2003

Application:
T444E

Filters

PFF4595



Fuel Filter Element Service Kit (Racor)

OEM Part Number: 1822631C91

Year Range:
1994–2003

Application:
T444E

RK31019



Fuel Filter Top Cover (Racor)

Year Range:
1994–2003

Application:
T444E

VT365, VT275, MAXXFORCE 5

Injectors

Remanufactured G2.8 Injector*

OEM Part Numbers: 1843089C91, 1843481C95, 1845879C91, 1878281C92, 1878282C91

Year Range: 2002½–2003
Application: VT365

Remanufactured G2.8 Injector*

OEM Part Numbers: 1844751C2, 1845150C92, 1846692C92, 1877748C1, 1878284C91, 1878285C91, 1879998C91

Year Range: 2004–2006
2006
2007–2010
Application: VT365
VT275
MaxxForce 5

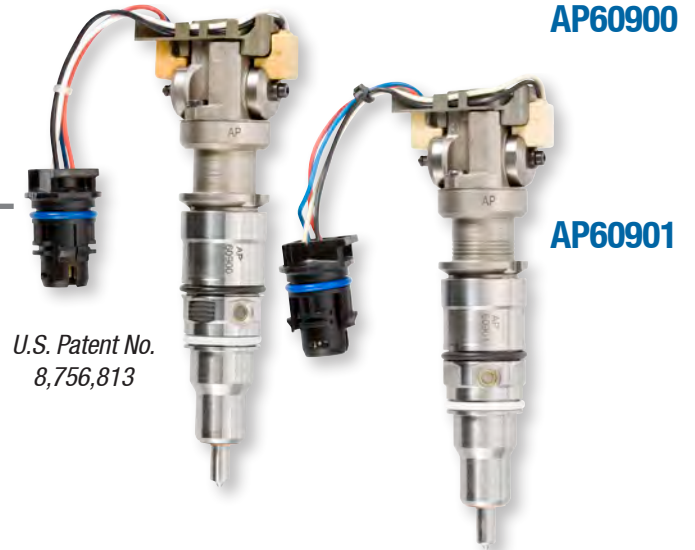

Fuel System Components

Fuel Filter Heater Element

OEM Part Number: 1831196C92

Year Range: 2003–2007
Application: VT365

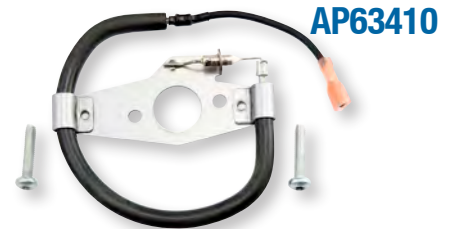

Engine Components

Oil Cooler/Exhaust Gas Recirculation (EGR) Cooler Kit

Notes: Includes AP63451 Engine Oil Cooler Kit and AP63446 Exhaust Gas Recirculation (EGR) Cooler Kit.

Year Range: 2004–2007
Application: VT365

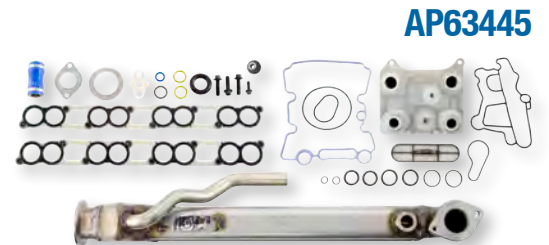

* Indicates products with a core charge.

VT365, VT275, MAXXFORCE 5

Engine Components *continued*

AP63446



Exhaust Gas Recirculation (EGR) Cooler Kit

OEM Part Number: 1845145C99

Notes: Includes AP63447 Exhaust Gas Recirculation (EGR) Cooler Intake Gasket Kit.

Year Range:
2004–2007

Application:
VT365

AP63451

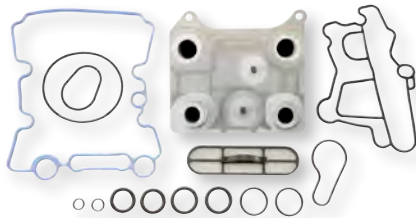

Engine Oil Cooler Kit

OEM Part Number: 1886511C93

Notes: Includes AP0039 Engine Oil Cooler Gasket Kit.

Year Range:
2003–2007
2006
2007–2010

Application:
VT365
VT275
MaxxForce 5

AP63583



Water Pump

OEM Part Number: 1845002C91

Notes: Includes mounting gasket.

Year Range:
2002–2007

Application:
VT365

AP63503



Water Pump

OEM Part Number: 5010118R91

Notes: Includes mounting gasket.

Year Range:
2006
2007–2010

Application:
VT275
MaxxForce 5

AP63661



Remanufactured High-Pressure Oil Pump*

OEM Part Numbers: 1882919C92, 1878865C91

Notes: Includes seal kit.

Year Range:
2004½–2007

Application:
VT365

* Indicates products with a core charge.

VT365, VT275, MAXXFORCE 5

Engine Components *continued*

Remanufactured High-Pressure Oil Pump*

OEM Part Numbers: 4307325R91, 1884357C92

Year Range: 2006
Application: VT275

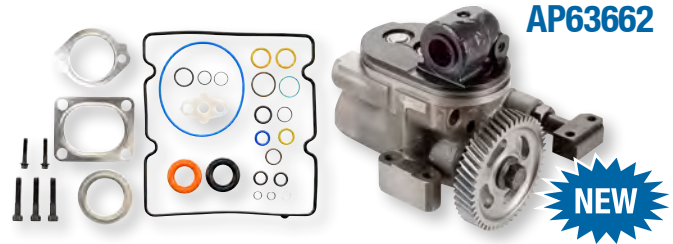

Remanufactured High-Pressure Oil Pump*

OEM Part Numbers: 4307327R91, 1880313C94

Year Range: 2007-2010
Application: MaxxForce 5

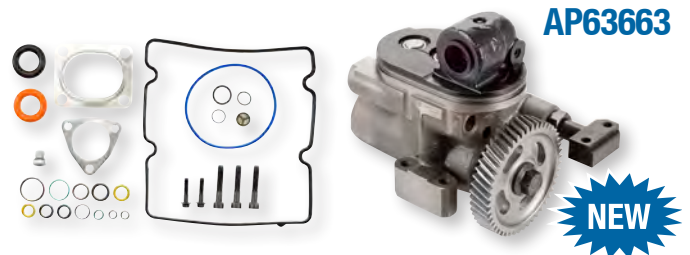

Remanufactured High-Pressure Oil Pump (Bosch)

OEM Part Number: 1838828C91

Notes: Includes seal kit.

Year Range: 2003-2004
Application: VT365



Sensors

Crankshaft Position (CKP) Sensor

OEM Part Number: 1828345C91

Year Range: 2003-2007
2006
2007-2010
Application: VT365
VT275
MaxxForce 5



Camshaft Position (CMP) Sensor

OEM Part Number: 1835985C92

Year Range: 2003-2007
2006
2007-2010
Application: VT365
VT275
MaxxForce 5



VT365, VT275, MAXXFORCE 5

Sensors *continued*

AP63435



Engine Oil Pressure (EOP) Sensor

OEM Part Number: 1831259C91

Year Range:	Application:
2006	VT275
2007–2010	MaxxForce 5

AP63437

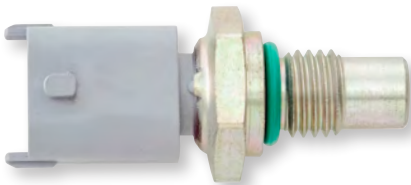

Engine Oil/Coolant/Fuel Temperature (EOT/ECT/FT) Sensor

OEM Part Number: 1836537C91

Year Range:	Application:
2003–2007	VT365
2006	VT275
2007–2010	MaxxForce 5

AP63403

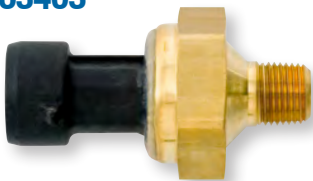

Exhaust Back Pressure (EBP) Sensor

OEM Part Number: 1850353C1

Year Range:	Application:
2003–2004	VT365

AP63408



Exhaust Back Pressure (EBP) Sensor

OEM Part Number: 1850352C2

Year Range:	Application:
2005–2007	VT365

AP63423



Exhaust Back Pressure (EBP) Sensor

OEM Part Number: 1846480C2

Year Range:	Application:
2007–2010	MaxxForce 5

AP63407



Injection Control Pressure (ICP) Sensor

OEM Part Number: 1845274C92

Notes: Mounts below turbo.

Year Range:	Application:
2003–2004	VT365

Sensors *continued*

Injection Control Pressure (ICP) Sensor

OEM Part Numbers: 1845428C92, 1845427C2

Notes: Mounts on passenger side valve cover.

Year Range:	Application:
2004–2007	VT365
2006	VT275
2007–2010	MaxxForce 5

AP63460

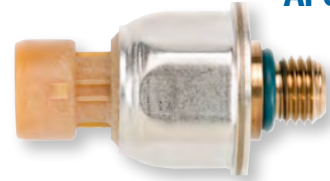

Intake Manifold Air Temperature (IAT) Sensor

OEM Part Number: 1836539C91

Year Range:	Application:
2003–2007	VT365
2006	VT275

AP63462

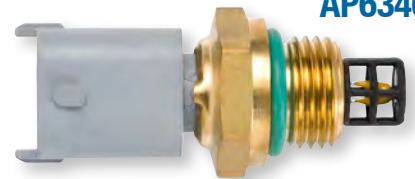

Intake Manifold Air Temperature (IAT) Sensor

OEM Part Number: 1875838C91

Year Range:	Application:
2007–2010	MaxxForce 5

AP63463

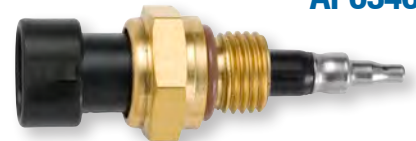

Manifold Absolute Pressure (MAP) Sensor

OEM Part Number: 1846481C92

Year Range:	Application:
2007–2010	MaxxForce 5

AP63476

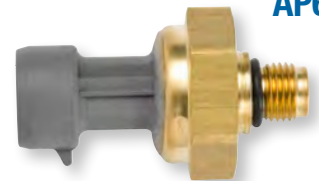

Visit alliantpower.com
For Additional Information
Such as Technical Bulletins and
New Product Announcements

VT365, VT275, MAXXFORCE 5

Actuators

AP63416



Injection Pressure Regulator (IPR) Valve

OEM Part Number: 1839437C95

Notes: Without edge filter.

Year Range:
2003–2004

Application:
VT365

AP63417



Injection Pressure Regulator (IPR) Valve

OEM Part Number: 1846057C1

Notes: With edge filter.

Year Range:
2005–2007
2006
2007–2010

Application:
VT365
VT275
MaxxForce 5

AP63438



Exhaust Gas Recirculation (EGR) Valve*

OEM Part Number: 1846491C91

Year Range:
2002½–2003

Application:
VT365

AP63459



Exhaust Gas Recirculation (EGR) Valve

OEM Part Number: 1846296C91

Year Range:
2004–2006

Application:
VT365

AP63479



Glow Plug Relay

OEM Part Number: 1840903C91

Year Range:
2003–2007
2006

Application:
VT365
VT275

* Indicates products with a core charge.

VT365, VT275, MAXXFORCE 5

Electrical Harness and Repair

Injection Control Pressure/Exhaust Back Pressure (ICP/EBP) Sensor Connector Pigtail

AP0021

Notes: Fits AP63407 and AP63460 Injection Control Pressure (ICP) Sensors, AP63403, AP63408, and AP63423 Exhaust Back Pressure (EBP) Sensors, as well as AP63476 Manifold Absolute Pressure (MAP) Sensor.

Year Range:	Application:
2003–2007	VT365
2006	VT275
2007–2010	MaxxForce 5



2 Wire Pigtail

AP0056

Notes: Fits AP63437 Engine Oil/Coolant/Fuel Temperature (EOT/ECT/FT) Sensor.

Year Range:	Application:
2003–2007	VT365
2006	VT275
2007–2010	MaxxForce 5



Injector Harness Connector

AP0030

Year Range:	Application:
2003–2007	VT365
2006	VT275
2007–2010	MaxxForce 5



G2.8 Injector Connector

AP0040

Notes: See Technical Bulletin APTB 03/14 for installation instructions.

Year Range:	Application:
2003–2007	VT365
2006	VT275
2007–2010	MaxxForce 5



Fuel Injection Control Module (FICM) Connector

AP0018

Notes: Field data shows identification marks 1456315–6, 1437287–7, or X–3.

Year Range:	Application:
2003–2007	VT365
2006	VT275

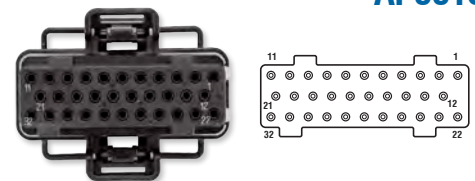

Fuel Injection Control Module (FICM) Connector

AP0019

Notes: Field data shows identification marks 1456315–2, 1437287–6, or X–2.

Year Range:	Application:
2003–2007	VT365
2006	VT275

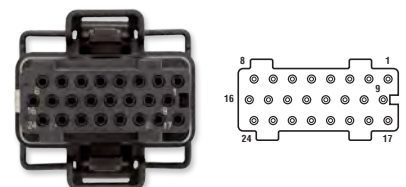

VT365, VT275, MAXXFORCE 5

Electrical Harness and Repair *continued*

AP0020

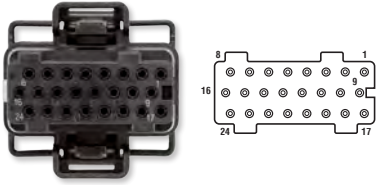

Fuel Injection Control Module (FICM) Connector

Notes: Field data shows identification marks 1456316-1, 1437287-5, or X-1.

Year Range:	Application:
2003-2007	VT365
2006	VT275

AP0068



2 Wire Pigtail

Notes: Fits AP63416 and AP63417 Injection Pressure Regulator (IPR) Valves and the VGT Solenoid.

Year Range:	Application:
2003-2007	VT365
2006	VT275
2007-2010	MaxxForce 5

Seal and Gasket Kits

AP0002



G2.8 Injector Seal Kit

OEM Part Number: 1843682C91

Notes: Includes high-pressure oil seal.

Year Range:	Application:
2002½-2007	VT365
2006	VT275
2007-2010	MaxxForce 5

AP0005



Exhaust Gas Recirculation (EGR) Valve O-ring Kit

OEM Part Number: 1840778C91

Year Range:	Application:
2003-2004	VT365

AP0023

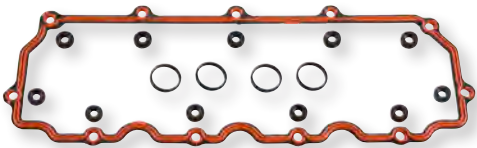

Valve Cover Gasket

OEM Part Number: 1838250C1

Year Range:	Application:
2003-2007	VT365

VT365, VT275, MAXXFORCE 5

Seal and Gasket Kits *continued*

Stand Pipe and Front Port Plug Seal Kit

AP0028

Notes: Reseals one side.

Year Range:	Application:
2003–2007	VT365
2006	VT275
2007–2010	MaxxForce 5



Injection Pressure Regulator (IPR) Valve Seal Kit

AP0035

OEM Part Number: 1888696C93

Year Range:	Application:
2003–2007	VT365
2006	VT275
2007–2010	MaxxForce 5



Engine Oil Cooler Gasket Kit

AP0039

Year Range:	Application:
2003–2007	VT365
2006	VT275
2007–2010	MaxxForce 5

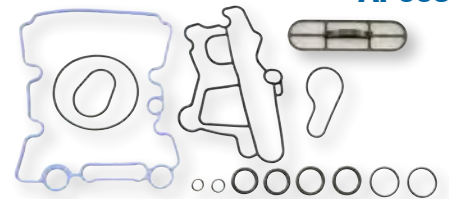

Exhaust Gas Recirculation (EGR) Valve Seal Kit

AP0057

OEM Part Number: 1858088C92

Year Range:	Application:
2004–2006	VT365



High-Pressure Oil Rail Seal Kit

AP0070

Notes: AP0069 High-Pressure Oil Rail Socket required for installation.

Year Range:	Application:
2003–2007	VT365
2006	VT275
2007–2010	MaxxForce 5



Exhaust Gas Recirculation (EGR) Cooler Intake Gasket Kit

AP63447

OEM Part Number: 1840702C97

Year Range:	Application:
2003–2007	VT365



VT365, VT275, MAXXFORCE 5

Filters

PFF31795



Fuel Filter Housing Cap (Racor)

OEM Part Number: 1843057C92

Year Range:	Application:
2006	VT275
2007–2010	MaxxForce 5

PFF4616



Fuel Filter Element Service Kit (Racor)

Notes: Primary and secondary.

Year Range:	Application:
2006	VT275
2007–2010	MaxxForce 5

PFL2016



Oil Filter Element Service Kit (Racor)

Year Range:	Application:
2003–2007	VT365

RK31821



Oil Filter Cap (Racor)

OEM Part Number: 1840754C91

Year Range:	Application:
2003–2007	VT365
2006	VT275
2007–2010	MaxxForce 5

PFF4596



Fuel Filter Element Service Kit (Racor)

Year Range:	Application:
2003–2007	VT365

RK31449



Fuel Filter Top Cover (Racor)

Year Range:	Application:
2003–2007	VT365

Injectors

Remanufactured Piezo Injector*

OEM Part Numbers: 1873422C93, 4307381R91, 4307369R91, 5010359R93

Notes: Pre-2010 emission engines. Includes injection line.

Year Range: 2007-2010	Application: MaxxForce 7	ESN Range: 434,544 to 5,300,001
---------------------------------	------------------------------------	---

AP64900



AP64901



Remanufactured Piezo Injector*

OEM Part Numbers: 1883110C1, 1883111C92, 1899239C92

Notes: Post 2010 emission engines. Includes injection line.

Year Range: 2010-2014	Application: MaxxForce 7	ESN Range: 5,300,002 to End
---------------------------------	------------------------------------	---------------------------------------

Engine Components

Remanufactured High-Pressure Fuel Pump (HPFP) Kit*

OEM Part Numbers: 4307291R91, 1876529C98, 1855860C94

Notes: Pre-2010 emission engines. Includes pump and installation kit.

Year Range: 2007-2010	Application: MaxxForce 7
---------------------------------	------------------------------------

AP63641

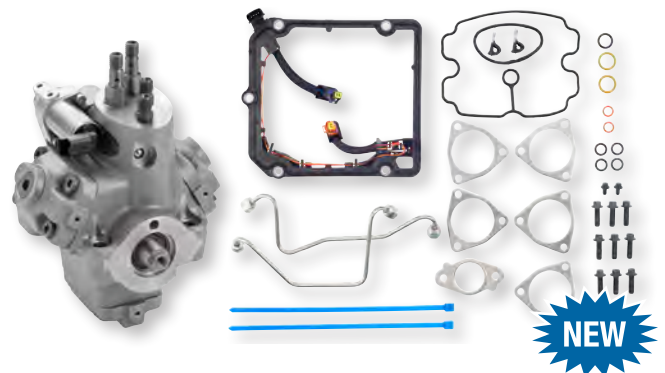

Remanufactured High-Pressure Fuel Pump (HPFP) Kit*

OEM Part Number: 7080839C92

Notes: Post 2010 emission engines. Includes pump and installation kit.

Year Range: 2010-2014	Application: MaxxForce 7
---------------------------------	------------------------------------

AP63642

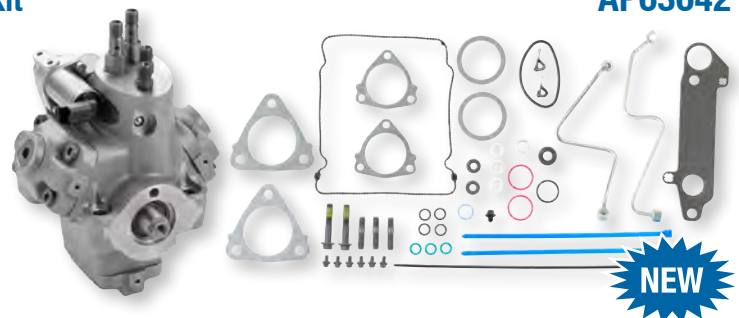

* Indicates products with a core charge.

MAXXFORCE 7

Engine Components *continued*

AP63480



Fuel Supply Hose

OEM Part Number: 7081021C1

Notes: Install in engines built BEFORE 04/06/2011.

Year Range:
2010–2014

Application:
MaxxForce 7

Sensors

AP63412



Crankshaft Position (CKP) Sensor

OEM Part Number: 1828345C91

Year Range:
2007–2012

Application:
MaxxForce 7

AP63415



Camshaft Position (CMP) Sensor

OEM Part Number: 1835985C92

Year Range:
2007–2012

Application:
MaxxForce 7

AP63422



Fuel Rail Pressure Sensor

OEM Part Number: 1873400C92

Notes: Includes gasket.

Year Range:
2007–2012

Application:
MaxxForce 7

AP63423

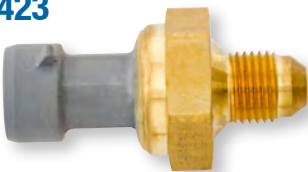

Exhaust Back Pressure (EBP) Sensor

OEM Part Number: 1846480C2

Year Range:
2007–2010

Application:
MaxxForce 7

Sensors *continued*

Engine Oil/Coolant/Fuel Temperature (EOT/ECT/FT) Sensor

OEM Part Number: 1836537C91

Year Range: 2007–2012
Application: MaxxForce 7

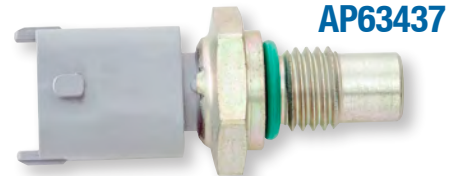

AP63437

Intake Manifold Air Temperature (IAT) Sensor

OEM Part Number: 1875838C91

Year Range: 2007–2009
Application: MaxxForce 7

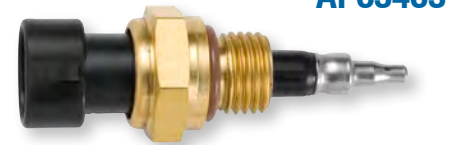

AP63463

Exhaust Gas Recirculation (EGR) Temperature Sensor–Inlet

OEM Part Number: 1845988C1

Year Range: 2010–2011
Application: MaxxForce 7

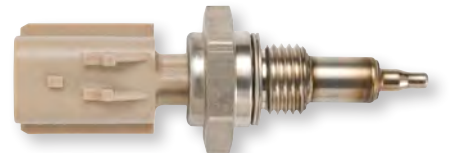

AP63470

Exhaust Gas Recirculation (EGR) Temperature Sensor–Outlet

OEM Part Number: 1888560C1

Year Range: 2010–2011
Application: MaxxForce 7



AP63471

Manifold Absolute Pressure (MAP) Sensor

OEM Part Number: 1846481C92

Year Range: 2007–2011
Application: MaxxForce 7

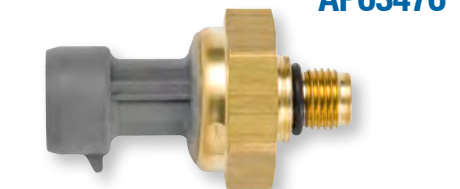

AP63476

MAXXFORCE 7

Actuators

AP63456

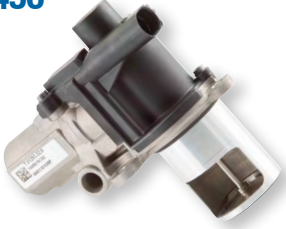

Exhaust Gas Recirculation (EGR) Valve

OEM Part Number: 1885819C92

Year Range:
2007–2010

Application:
MaxxForce 7

Electrical Harness and Repair

AP0021



Exhaust Back Pressure/Manifold Absolute Pressure (EBP/MAP) Sensor Connector Pigtail

Notes: Fits AP63423 Exhaust Back Pressure (EBP) Sensor and AP63476 Manifold Absolute Pressure (MAP) Sensor.

Year Range:
2007–2010

Application:
MaxxForce 7

AP0056



2 Wire Pigtail

Notes: Fits AP63437 Engine Oil/Coolant//Fuel Temperature (EOT/ECT/FT) Sensor.

Year Range:
2007–2012

Application:
MaxxForce 7

Seal and Gasket Kits

AP0027



Injection Line and O-ring Kit

OEM Part Numbers: 1855644C3, 1886547C1, 1873425C93

Year Range:
2007–2012

Application:
MaxxForce 7

AP0042



Exhaust Gas Recirculation (EGR) Valve O-ring

OEM Part Number: 1847321C1

Year Range:
2007–2010

Application:
MaxxForce 7

Seal and Gasket Kits *continued*

High-Pressure Fuel Pump (HPFP) Installation Kit

Notes: Pre-2010 emission engines. Installation kit only. If pump is needed see AP63641 Remanufactured High-Pressure Fuel Pump (HPFP) Kit.

Year Range: 2007-2010
Application: MaxxForce 7

AP0072



High-Pressure Fuel Pump (HPFP) Installation Kit

Notes: Post 2010 emission engines. Installation kit only. If pump is needed see AP63642 Remanufactured High-Pressure Fuel Pump (HPFP) Kit.

Year Range: 2010-2014
Application: MaxxForce 7

AP0073

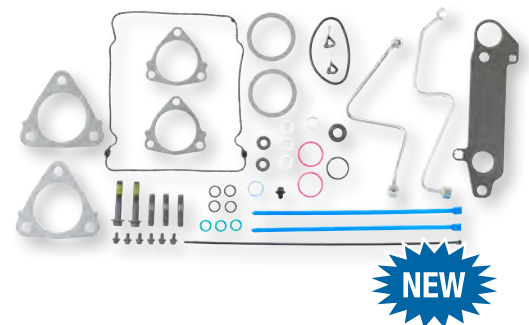

Filters

Oil Filter Element Service Kit (Racor)

Year Range: 2007-2010
Application: MaxxForce 7

PFL2016



Oil Filter Cap (Racor)

OEM Part Number: 1840754C91

Year Range: 2007-2010
Application: MaxxForce 7

RK31821



DT466E, I530E, DT466 / 530, HT530

Injectors

AP63805BA



HEUI Injector*

OEM Part Numbers: 181934C1, 1819834C1, 1823736C94, 1824917C2, 1824928C94, 2593588C91

Notes: Includes copper chamber gasket.

Year Range: 1995–1997	Application: DT466E: 230 HP (HT) to 250 HP (HT)	ESN Range: 933,834 to 1,084,867
---------------------------------	---	---

AP63806BB

HEUI Injector*

OEM Part Numbers: 1824739C1, 1824742C91, 1824918C2, 1824929C94, 2593589C91

Notes: Includes copper chamber gasket.

Year Range: 1995–1997	Application: DT466E: 175 HP to 190 HP	ESN Range: 933,834 to 1,028,710
---------------------------------	---	---

AP63807BC

HEUI Injector*

OEM Part Numbers: 1824740C1, 1824743C91, 1824919C2, 1824930C94, 2593590C91

Notes: Includes copper chamber gasket.

Year Range: 1995–1997	Application: DT466E: 195 HP to 230 HP	ESN Range: 933,834 to 1,028,710
---------------------------------	---	---

AP63808BD

HEUI Injector*

OEM Part Numbers: 1824741C2, 1824744C94, 1824920C2, 1824931C94, 2593591C91

Notes: Includes copper chamber gasket.

Year Range: 1995–1997	Application: I530E: 250 HP to 300 HP (HT)	ESN Range: 933,834 to 1,084,028
---------------------------------	---	---

AP63809BE

HEUI Injector*

OEM Part Numbers: 1824839C94, 1829336C1, 1829837C2, 1829838C94, 1829839C93, 1829926C2, 2593592C91

Notes: Includes copper chamber gasket.

Year Range: 1997–1999	Application: DT466E: 175 HP to 190 HP	ESN Range: 1,028,711 to 1,194,038
---------------------------------	---	---

AP63810BF

HEUI Injector*

OEM Part Numbers: 1830145C91, 1830146C94, 1830147C2, 1830148C2, 2593593C91

Notes: Includes copper chamber gasket.

Year Range: 1998–1999	Application: I530E: 250 HP to 300 HP (HT)	ESN Range: 1,084,029 to 1,134,350
---------------------------------	---	---

* Indicates products with a core charge.

DT466E, I530E, DT466 / 530, HT530

Injectors *continued*

HEUI Injector*

OEM Part Numbers: 1830559C91, 1830560C2, 1830561C92, 1830562C2, 1830740C92, 1830741C92, 2593594C91, 2593595C91

Notes: Includes stainless steel and copper chamber gaskets.

Year Range:	Application:	ESN Range:
1999	DT466E: 175 HP to 250 HP (HT)	1,125,228 to 1,999,999
2000–2003	DT466: 175 HP to 250 HP (HT)	1,125,228 to 1,999,999

HEUI Injector

OEM Part Numbers: 1830155C91, 1830156C91, 1830157C1, 1830158C1, 1830570C91, 1830573C2, 2593596C91

Notes: Discontinued, supersedes to AP63812BJ HEUI Injector.

Year Range:	Application:	ESN Range:
1997–1999	DT466E: 230 HP (HT) to 250 HP (HT)	1,084,868 to 1,125,227

HEUI Injector*

OEM Part Numbers: 1830094C92, 1830570C92, 1830571C2, 1830572C93, 1830573C2, 2593596C91

Notes: Includes copper chamber gasket.

Year Range:	Application:	ESN Range:
1999	I530E: 230 HP (HT) to 300 HP (HT)	1,133,755 to 1,194,038

HEUI Injector*

OEM Part Numbers: 1830691C1, 1830692C91, 1830693C1, 1830694C93, 2593597C91

Notes: Includes stainless steel chamber gasket.

Year Range:	Application:	ESN Range:
2000–2003	DT530, HT530: 250 HP to 340 HP (HT)	1,194,039 to 1,999,999

HEUI Injector*

OEM Part Numbers: 1836250C1, 1836251C91, 1836252C91, 1836253C1

Notes: Includes stainless steel chamber gasket.

Year Range:	Application:
2000 and Later	DT466 Transit



AP63811BI

BG

AP63812BJ

AP63813BN

AP63814BP

DT466E, I530E, DT466 / 530, HT530

Engine Components

AP63434



HEUI Injector Sleeve—Stainless Steel

OEM Part Number: 1818778C3

Notes: Engines built ON or AFTER 03/1996.

Year Range:

1996–1999

2000–2003

Application:

DT466E, I530E

DT466 / 530, HT530

AP63452

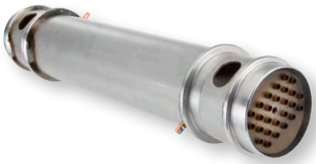

Engine Oil Cooler

OEM Part Number: 1815904C2

Year Range:

1995–1999

2000–2003

Application:

DT466E, I530E

DT466 / 530, HT530

AP63580



Water Pump

OEM Part Numbers: 1817687C92, 1821935C3, 1830606C94

Notes: Includes mounting gasket. Engines built ON or AFTER 09/1993.

Year Range:

1994–1999

2000–2003

Application:

DT466E, I530E

DT466 / 530, HT530

HP020X



Remanufactured High-Pressure Oil Pump (Bosch)

OEM Part Numbers: 1830177C92, 1842722C91

Notes: Includes mounting gasket. 6.5cc pump.

Year Range:

1994–1999

2000–2003

Application:

I530E: 230 HP (HT) to 300 HP

DT466 / 530, HT530: 230 HP (HT) to 300 HP

HP021X



Remanufactured High-Pressure Oil Pump (Bosch)

OEM Part Numbers: 1825681C95, 1842721C91

Notes: Includes mounting gasket. 5.3cc pump.

Year Range:

1994–1999

2000–2003

Application:

DT466E: 175 HP to 230 HP

DT466: 175 HP to 230 HP

HP022X

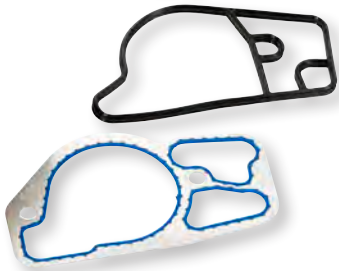

Remanufactured High-Pressure Oil Pump (Bosch)

OEM Part Numbers: 1842723C91, 1826458C92

Notes: Includes mounting gasket. 7.0cc pump.

Year Range:

1994–1999

2000–2003

Application:

I530E: 300 HP to 330 HP

DT530, HT530: 300 HP to 330 HP

DT466E, I530E, DT466 / 530, HT530

Sensors

Manifold Absolute Pressure (MAP) Sensor

OEM Part Number: 1840078C1

Notes: Mounts on intake manifold.

Year Range:

1998–2003

Application:

DT466E, I530E, DT466 / 530, HT530

AP63429

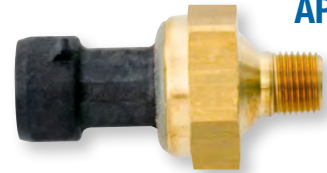

Injection Control Pressure (ICP) Sensor

OEM Part Number: 1830669C92

Year Range:

See ESN

Application:

DT466E, I530E, DT466 / 530, HT530

ESN Range:

1,134,351 to 1,999,999

AP63465



Engine Oil Pressure (EOP) Sensor

OEM Part Number: 1807369C2

Year Range:

See ESN

Application:

DT466E, I530E, DT466 / 530, HT530

ESN Range:

1,126,949 to 1,999,999

AP63466

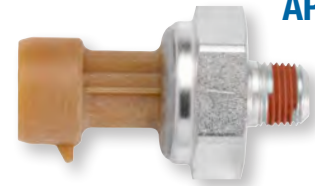

Actuators

Injection Pressure Regulator (IPR) Valve

OEM Part Numbers: 1824982C91, 1833798C91, 1841279C91

Notes: With edge filter.

Year Range:

1994–1995½

Application:

DT466E, I530E

ESN Range:

0 to 998,705

AP63401



Injection Pressure Regulator (IPR) Valve

OEM Part Numbers: 1829856C91, 1836412C91, 1841086C91, 1841217C91

Notes: Without edge filter.

Year Range:

1995½–2003

Application:

DT466E, I530E

ESN Range:

998,706 to 1,999,999

2000–2003

DT466 / 530, HT530

998,706 to 1,999,999

AP63402



DT466E, I530E, DT466 / 530, HT530

Electrical Harness and Repair

AP0021



Injection Control Pressure/Engine Oil Pressure (ICP/EOP) Sensor Connector Pigtail

Notes: Fits AP63465 Injection Control Pressure (ICP) Sensor and AP63466 Engine Oil Pressure (EOP) Sensor.

Year Range:
1994–2003

Application:
DT466E, I530E, DT466 / 530, HT530

AP0068



2 Wire Pigtail

Notes: Fits AP63401 and AP63402 Injection Pressure Regulator (IPR) Valves and all HEUI B Injectors.

Year Range:
1994–1999
2000–2003

Application:
DT466E, I530E
DT466 / 530, HT530

AP63464



Internal Injector Harness

OEM Part Numbers: 1889905C91, 30360R1, 1824908C1

Notes: Includes mounting bolts.

Year Range:
1994–2003

Application:
DT466E, I530E, DT466 / 530, HT530

Seal and Gasket Kits

AP0001



HEUI Injector Seal Kit

OEM Part Number: 1833564C92

Year Range:
1994–1999
2000–2003

Application:
DT466E, I530E
DT466 / 530, HT530

AP0003

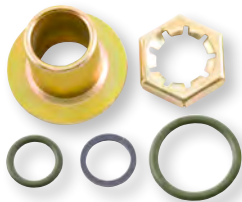

Injection Pressure Regulator (IPR) Valve Seal Kit

OEM Part Number: 1825806C91

Year Range:
1994–1999
2000–2003

Application:
DT466E, I530E
DT466 / 530, HT530

DT466E, I530E, DT466 / 530, HT530

Seal and Gasket Kits *continued*

Stainless Steel Chamber Gaskets

OEM Part Number: 1830317C1

Notes: Package of six.

Year Range:
As Required

Application:

DT466E, I530E, DT466 / 530, HT530

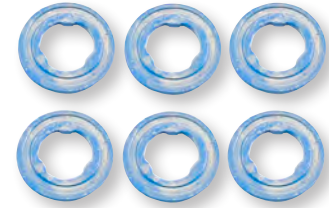

AP0006

Valve Cover Gasket

OEM Part Numbers: 1820909C1, 1825602C91

Year Range:
1994–1999
2000–2003

Application:

DT466E, I530E
DT466 / 530, HT530

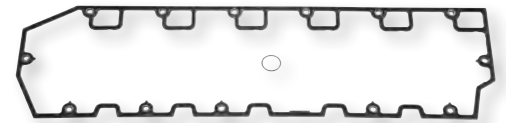

AP0036

Primer Pump Seal Kit

Year Range:
1995–2003

Application:

DT466E, I530E, DT466 / 530, HT530



AP0038

*All Alliant Power Products
are Backed with a 13–Month
Unlimited Mileage Warranty*

PERKINS, DETROIT DIESEL, AGCO

Injectors

AP63805BA



HEUI Injector*

OEM Part Numbers: 181934C1, 1819834C1, 1823736C94, 1824917C2, 1824928C94, 2593588C91

Notes: Includes copper chamber gasket.

Year Range: 1995–1997 **Engine:** 7.6 L Perkins 1300 Series EDi

AP63808BD

HEUI Injector*

OEM Part Numbers: 1824741C2, 1824744C94, 1824920C2, 1824931C94, 2593591C91

Notes: Includes copper chamber gasket.

Year Range: 1995–1997 **Engine:** 8.7 L Perkins 1300 Series EDi

AP63810BF

HEUI Injector*

OEM Part Numbers: 1830145C91, 1830146C94, 1830147C2, 1830148C2, 2593593C91

Notes: Includes copper chamber gasket.

Year Range: 1998–1999 **Engine:** 8.7 L Perkins 1300 Series EDi
 1998–1999 8.7 L Detroit Diesel Series 40E
 1998–1999 8.7 L AGCO 9675

AP63811BI

HEUI Injector*

OEM Part Numbers: 1830559C91, 1830560C2, 1830561C92, 1830562C2, 1830740C92, 1830741C92, 2593594C91, 2593595C91

Notes: Includes stainless steel and copper chamber gaskets.

Year Range: 1999–2003 **Engine:** 7.6 L Perkins 1300 Series EDi

AP63812BJ

HEUI Injector*

OEM Part Numbers: 1830094C92, 1830570C92, 1830571C2, 1830572C93, 1830573C2, 2593596C91

Notes: Includes copper chamber gasket.

Year Range: 1999 **Engine:** 8.7 L Perkins 1300 Series EDi
 1999 8.7 L Detroit Diesel Series 40E

* Indicates products with a core charge.

Injectors continued

HEUI Injector*

OEM Part Numbers: 1830691C1, 1830692C91, 1830693C1, 1830694C93, 2593597C91

Notes: Includes stainless steel chamber gasket.

Year Range:	Engine:
2000–2003	8.7 L Perkins 1300 Series EDi
2000–2003	8.7 L Detroit Diesel Series 40E

AP63813BN

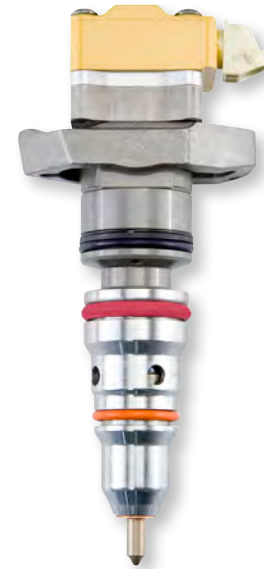

AP63814BP

HEUI Injector*

OEM Part Numbers: 1836250C1, 1836251C91, 1836252C91, 1836253C1

Notes: Includes stainless steel chamber gasket.

Year Range:	Engine:
2000 and Later	7.6 L Detroit Diesel Series 40E

Seal and Gasket Kits

HEUI Injector Seal Kit

OEM Part Number: 1833564C92

Year Range:	Engine:
1995–1997	7.6 L Perkins 1300 Series EDi
1999–2003	7.6 L Perkins 1300 Series EDi
1995–2003	8.7 L Perkins 1300 Series EDi
1998–2003	8.7 L Detroit Diesel Series 40E
2000 and Later	7.6 L Detroit Diesel Series 40E
1998–1999	8.7 L AGCO 9675

AP0001



***Visit alliantpower.com
to Find Your Nearest
Service Dealer***

DT466 / 570, HT570, MAXXFORCE DT / 9 / 10

Injectors

AP66976

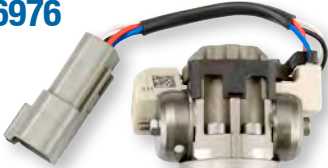

Remanufactured G2.9 Injector*

OEM Part Numbers: 1842576C93, 5010656R92, 1841491C91, 1842223C91

Notes: Installation requires removal of high–pressure oil rail. Use AP0025 High–Pressure Oil Rail Seal Kit when reinstalling oil rail.

Year Range:	Application:	ESN Range:
2004	DT466: 210 HP to 225 HP	2,000,001 to 2,999,999

AP66977



Remanufactured G2.9 Injector*

OEM Part Numbers: 1842577C93, 5010657R92, 1842224C91

Notes: Installation requires removal of high–pressure oil rail. Use AP0025 High–Pressure Oil Rail Seal Kit when reinstalling oil rail.

Year Range:	Application:	ESN Range:
2004	DT466: 245 HP to 285 HP (HT)	2,000,001 to 2,999,999
2005	DT466: 210 HP to 285 HP	2,000,001 to 2,999,999

AP66978

Remanufactured G2.9 Injector*

OEM Part Numbers: 1842578C94, 5010658R92, 1842225C91

Notes: Installation requires removal of high–pressure oil rail. Use AP0025 High–Pressure Oil Rail Seal Kit when reinstalling oil rail.

Year Range:	Application:	ESN Range:
2004–2005	DT570: 285 HP to 330 HP	2,000,001 to 2,999,999

AP66979

Remanufactured G2.9 Injector*

OEM Part Numbers: 1842579C94, 5010659R92, 1842226C91

Notes: Installation requires removal of high–pressure oil rail. Use AP0025 High–Pressure Oil Rail Seal Kit when reinstalling oil rail.

Year Range:	Application:	ESN Range:
2004–2005	HT570: 295 HP to 340 HP (HT)	2,000,001 to 2,999,999

AP66989

Remanufactured G2.9 BANG Injector*

OEM Part Number: 1848489C91

Notes: Installation requires removal of high–pressure oil rail. Use AP0025 High–Pressure Oil Rail Seal Kit when reinstalling oil rail.

Year Range:	Application:
2006	DT466: 210 HP to 285 HP

AP66992

Remanufactured G2.9 BANG Injector*

OEM Part Number: 1848492C91

Notes: Installation requires removal of high–pressure oil rail. Use AP0025 High–Pressure Oil Rail Seal Kit when reinstalling oil rail.

Year Range:	Application:
2006	DT570: 285 HP to 330 HP

* Indicates products with a core charge.

DT466 / 570, HT570, MAXXFORCE DT / 9 / 10

Injectors *continued*

Remanufactured G2.9 BANG Injector*

OEM Part Number: 1848495C91

Notes: Installation requires removal of high-pressure oil rail. Use AP0025 High-Pressure Oil Rail Seal Kit when reinstalling oil rail.

Year Range: 2006
Application: HT570: 295 HP to 340 HP (HT)

AP66995



Remanufactured G2.9 Injector*

OEM Part Numbers: 1848718C92, 5010561R91

Notes: Installation requires removal of high-pressure oil rail. Use AP0025 High-Pressure Oil Rail Seal Kit when reinstalling oil rail.

Year Range: 2007–2010
Application: MaxxForce DT: 210 HP to 300 HP
ESN Range: 3,000,001 to 3,300,000

AP66918

Remanufactured G2.9 Injector*

OEM Part Numbers: 1848721C92, 4307212R91

Notes: Installation requires removal of high-pressure oil rail. Use AP0025 High-Pressure Oil Rail Seal Kit when reinstalling oil rail.

Year Range: 2007–2010
Application: MaxxForce 9: 300 HP to 330 HP
 2007–2010 MaxxForce 10: 310 HP to 350 HP
ESN Range: 3,000,001 to 3,300,000

AP66921

G2.9 Injector*

OEM Part Numbers: 1890055C92, 1890056C2

Notes: Installation requires removal of high-pressure oil rail. Use AP0025 High-Pressure Oil Rail Seal Kit when reinstalling oil rail.

Year Range: 2010–2014
Application: MaxxForce DT: 215 HP to 300 HP

AP66855



G2.9 Injector*

OEM Part Numbers: 1884057C92, 1884058C2

Notes: Installation requires removal of high-pressure oil rail. Use AP0025 High-Pressure Oil Rail Seal Kit when reinstalling oil rail.

Year Range: 2010–2014
Application: MaxxForce DT: 210 HP to 225 HP

AP66857



G2.9 Injector*

OEM Part Numbers: 1890057C92, 1890058C2

Notes: Installation requires removal of high-pressure oil rail. Use AP0025 High-Pressure Oil Rail Seal Kit when reinstalling oil rail.

Year Range: 2010–2014
Application: MaxxForce 9: 300 HP to 330 HP
 2010–2014 MaxxForce 10: 310 HP to 350 HP

AP66858



DT466 / 570, HT570, MAXXFORCE DT / 9 / 10

Engine Components

AP63582



Water Pump

OEM Part Numbers: 1842664C92, 1842665C93

Notes: Includes mounting gasket.

Year Range:
2004–2006
2007–2010

Application:
DT466 / 570, HT570
MaxxForce DT / 9 / 10

AP63680



12cc High-Pressure Oil Pump*

OEM Part Numbers: 1885044C2, 1885043C92, 1889323C93

Year Range:
2010–2014

Application:
MaxxForce DT

ESN Range:
3,300,001 to End

AP63681



16cc High-Pressure Oil Pump*

OEM Part Numbers: 1885046C2, 1885045C92, 1889324C92

Year Range:
2010–2014

Application:
MaxxForce 9 / 10

ESN Range:
3,300,001 to End

Notes For AP63680 & AP63681: Injection Pressure Regulator (IPR) Valve is included.

AP63682



12cc High-Pressure Oil Pump*

OEM Part Numbers: 1883888C93, 1842424C2, 1871291C4, 1842423C97, 1871292C96, 1842614C91

Year Range:
2004–2006

Application:
DT466

ESN Range:
2,000,001 to 2,999,999

AP63683



16cc High-Pressure Oil Pump*

OEM Part Numbers: 1885000C93, 1842426C2, 1842425C96, 1842617C91

Year Range:
2004–2006

Application:
DT570, HT570

ESN Range:
2,000,001 to 2,999,999

Notes For AP63682 & AP63683: Injection Pressure Regulator (IPR) Valve and Fuel Supply Pump are included.

* Indicates products with a core charge.

DT466 / 570, HT570, MAXXFORCE DT / 9 / 10

Engine Components *continued*

12cc High-Pressure Oil Pump Kit*

OEM Part Numbers: 1876105C95, 1832093C2, 1879744C2, 1832092C92, 1879743C93

Year Range: 2007-2010	Application: MaxxForce DT	ESN Range: 3,000,001 to 3,040,000
---------------------------------	-------------------------------------	---

AP63684

16cc High-Pressure Oil Pump Kit*

OEM Part Numbers: 1882259C93, 1876106C94, 1832095C2, 1832094C92

Year Range: 2007-2010	Application: MaxxForce 9 / 10	ESN Range: 3,000,001 to 3,040,000
---------------------------------	---	---

Notes For AP63684 & AP63685: Injection Pressure Regulator (IPR) Valve, Fuel Supply Pump, updated High-Pressure Hose and Fitting are included. OEM part numbers for both the early and late 16cc High-Pressure Pumps (AP63685 and AP63687) supersede to 1882259C93. The ESN must be used to determine which Alliant Power part number is required.



AP63685

12cc High-Pressure Oil Pump*

OEM Part Numbers: 1882258C93, 1832093C2, 1879744C2, 1832092C92, 1879743C93

Year Range: 2007-2010	Application: MaxxForce DT	ESN Range: 3,040,001 to 3,300,000
---------------------------------	-------------------------------------	---

AP63686

16cc High-Pressure Oil Pump*

OEM Part Numbers: 1882259C93, 1832095C2, 1832094C92, 1879747C2, 1879745C93

Year Range: 2007-2010	Application: MaxxForce 9 / 10	ESN Range: 3,040,001 to 3,300,000
---------------------------------	---	---

Notes For AP63686 & AP63687: Injection Pressure Regulator (IPR) Valve and Fuel Supply Pump are included. OEM part numbers for both the early and late 16cc High-Pressure Pumps (AP63685 and AP63687) supersede to 1882259C93. The ESN must be used to determine which Alliant Power part number is required.



AP63687

DT466 / 570, HT570, MAXXFORCE DT / 9 / 10

Sensors

AP63412



Camshaft Position (CMP) Sensor

OEM Part Number: 1828345C91

Year Range: 2004–2006
2007–2010

Application: DT466 / 570, HT570
MaxxForce DT / 9 / 10

AP63415



Crankshaft Position (CKP) Sensor

OEM Part Number: 1835985C92

Year Range: 2004–2006
2007–2010

Application: DT466 / 570, HT570
MaxxForce DT / 9 / 10

AP63423

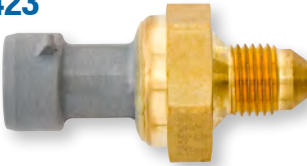

Exhaust Back Pressure (EBP) Sensor

OEM Part Number: 1846480C2

Year Range: 2004–2006
2007–2010

Application: DT466 / 570, HT570
MaxxForce DT / 9 / 10

AP63437

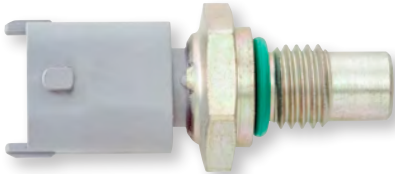

Engine Oil/Coolant/Fuel Temperature (EOT/ECT/FT) Sensor

OEM Part Number: 1836537C91

Year Range: 2004–2006
2007–2010

Application: DT466 / 570, HT570
MaxxForce DT / 9 / 10

AP63462

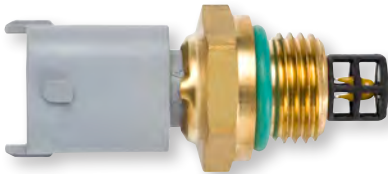

Intake Manifold Air Temperature (IAT) Sensor

OEM Part Number: 1836539C91

Year Range: 2004–2006

Application: DT466 / 570, HT570

AP63471



Exhaust Gas Recirculation (EGR) Temperature Sensor–Outlet

OEM Part Number: 1888560C1

Year Range: 2010–2011

Application: MaxxForce DT / 9 / 10

DT466 / 570, HT570, MAXXFORCE DT / 9 / 10

Sensors *continued*

Manifold Absolute Pressure (MAP) Sensor

OEM Part Number: 1846481C92

Year Range: 2007–2011
Application: MaxxForce DT / 9 / 10

AP63476

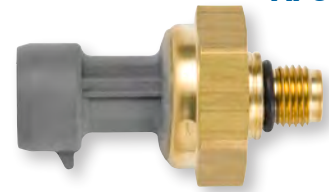

Electrical Harness and Repair

Exhaust Back Pressure/Manifold Absolute Pressure (EBP/MAP) Sensor Connector Pigtail

Notes: Fits AP63423 Exhaust Back Pressure (EBP) Sensor and AP63476 Manifold Absolute Pressure (MAP) Sensor.

Year Range: 2004–2006
2007–2010
Application: DT466 / 570, HT570
MaxxForce DT / 9 / 10

AP0021



2 Wire Pigtail

Notes: Fits AP63437 Engine Oil/Coolant/Fuel Temperature (EOT/ECT/FT) Sensor.

Year Range: 2004–2006
2007–2010
Application: DT466 / 570, HT570
MaxxForce DT / 9 / 10

AP0056



Fuel Injection Control Module (FICM) Connector

Notes: Field data shows identification marks 1456315–6, 1437287–7, or X–3.

Year Range: 2004–2006
Application: DT466 / 570, HT570

AP0018

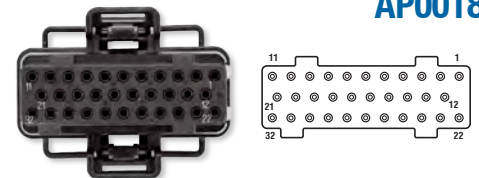

Fuel Injection Control Module (FICM) Connector

Notes: Field data shows identification marks 1456315–2, 1437287–6, or X–2.

Year Range: 2004–2006
Application: DT466 / 570, HT570

AP0019

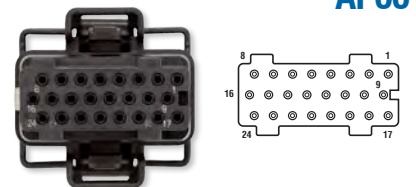

DT466 / 570, HT570, MAXXFORCE DT / 9 / 10

Electrical Harness and Repair *continued*

AP0020

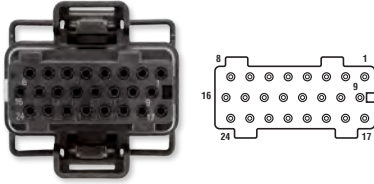

Fuel Injection Control Module (FICM) Connector

Notes: Field data shows identification marks 1456316-1, 1437287-5, or X-1.

Year Range:
2004-2006

Application:
DT466 / 570, HT570

AP0068



2 Wire Pigtail

Notes: Fits the Injection Pressure Regulator (IPR) Valves.

Year Range:
2004-2006
2007-2013

Application:
DT466 / 570, HT570
MaxxForce DT / 9 / 10

Seal and Gasket Kits

AP0006

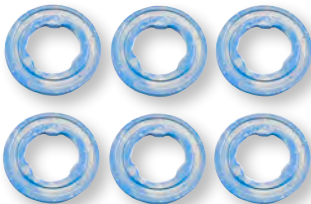

Stainless Steel Chamber Gaskets

OEM Part Number: 1830317C1

Notes: Package of six.

Year Range:
2004-2006
2007-2010

Application:
DT466 / 570, HT570
MaxxForce DT / 9 / 10

AP0025

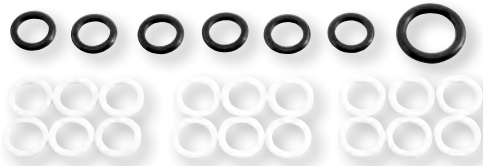

High-Pressure Oil Rail Seal Kit

OEM Part Number: 1842626C95

Year Range:
2004-2006
2007-2010

Application:
DT466 / 570, HT570
MaxxForce DT / 9 / 10

AP0026



G2.9 Injector Seal Kit

OEM Part Number: 1842624C92

Year Range:
2004-2006
2007-2010

Application:
DT466 / 570, HT570
MaxxForce DT / 9 / 10

***For Additional Information
such as OEM Cross Reference
and Product Instructions
Please Visit alliantpower.com***





6.5 L

Fuel System Components

AP63440



Fuel Transfer Pump

OEM Part Numbers: 25117340, EP309

Year Range: 1994–1999
Engine: 6.5 L

AP63441



Fuel Transfer Pump

OEM Part Numbers: 15754298, EP1000

Year Range: 1999–2002
Engine: 6.5 L

Engine Components

AP63560



Water Pump

OEM Part Numbers: 12530176, 19168610, 88894036, 251–590

Notes: Includes mounting gasket. Field data indicates both Water Pumps (AP63560 and AP63561) were used for MY 1999 vehicles. Be sure to verify which Water Pump is in place. Used for bolt-on pulley applications.

Year Range: 1994–1999
Engine: 6.5 L F, S, or Y

AP63561



Water Pump

OEM Part Numbers: 12556231, 88894035, 251–603, 252–776

Notes: Includes mounting gasket. Field data indicates both Water Pumps (AP63560 and AP63561) were used for MY 1999 vehicles. Be sure to verify which Water Pump is in place. Used for press-on pulley applications.

Year Range: 1999–2003
Engine: 6.5 L

Sensors

Engine Oil Pressure (EOP) Switch

OEM Part Numbers: 12555492, D1808A

Year Range: 1992–2002
Engine: 6.5 L

AP63419

Crankshaft Position (CKP) Sensor

OEM Part Numbers: 12557046, 213–337

Year Range: 1994–2002
Engine: 6.5 L

AP63444

Actuators

Glow Plug Relay

OEM Part Numbers: 12496472, 212–366

Year Range: 1994–2002
Engine: 6.5 L

AP63420

Turbo Wastegate Solenoid

OEM Part Numbers: 1997227, 214–1073

Year Range: 1994–2002
Engine: 6.5 L

AP63443

Electrical Harness and Repair

Engine Oil Pressure (EOP) Switch Connector Pigtail

OEM Part Numbers: 12085499, PT121

Year Range: 1992–2002
Engine: 6.5 L

AP0022

DS Pump 8" Wiring Harness Extension

Year Range: 1994–2002
Engine: 6.5 L

AP0024

6.5 L

Electrical Harness and Repair *continued*

AP0034



Turbo Wastegate Solenoid Connector Pigtail

Year Range: 1994–2002
Engine: 6.5 L

AP0067



Glow Plug Wire Harness Extension

OEM Part Number: 15320904
Year Range: 1994–2002
Engine: 6.5 L

Seal and Gasket Kits

APE65110



DS Pump Installation Kit

Year Range: 1992–2002
Engine: 6.5 L

Engine Accessories

AP63701



Vacuum Pump–Mechanical

OEM Part Numbers: 7849209, 215–115
Notes: Also fits 6.2 L.

Year Range: 1988–1995
Engine: 6.5 L

AP63702



Vacuum Pump–Mechanical

OEM Part Numbers: 89017558, 215–479
Year Range: 1996–2002
Engine: 6.5 L

6.6 L DURAMAX

Fuel System Components

Fuel Transfer Pump

OEM Part Numbers: 15161174, EP1001, EP1020, 15821962

Year Range: 2001–2011
Engine: 6.6 L Duramax



Fuel Return Line Banjo Bolt

OEM Part Number: 97228929

Year Range: 2001–2004½
Engine: 6.6 L LB7 Duramax

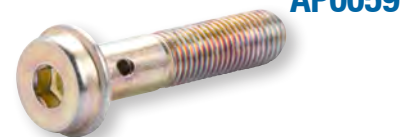

Injection Line

OEM Part Number: 97188720

Notes: Cylinders 1 and 8.

Year Range: 2001–2004½
Engine: 6.6 L LB7 Duramax



Injection Line

OEM Part Number: 97188721

Notes: Cylinders 3 and 6.

Year Range: 2001–2004½
Engine: 6.6 L LB7 Duramax



Injection Line

OEM Part Number: 97188722

Notes: Cylinders 4 and 5.

Year Range: 2001–2004½
Engine: 6.6 L LB7 Duramax



Injection Line

OEM Part Number: 97188723

Notes: Cylinders 2 and 7.

Year Range: 2001–2004½
Engine: 6.6 L LB7 Duramax



6.6 L DURAMAX

Engine Components

AP63457



Turbo Hose

OEM Part Numbers: 15019994, 15019995

Year Range:
2001–2004½

Engine:
6.6 L LB7 Duramax

AP63562

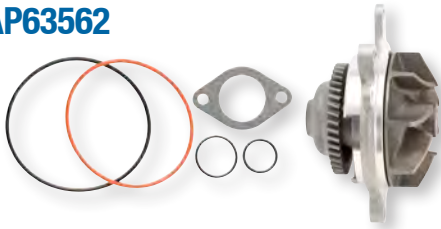

Water Pump

OEM Part Numbers: 97216136, 19113733, 19168888, 252–838, 251–674, 251–723

Notes: Includes mounting gaskets.

Year Range:
2001–2005

Engine:
6.6 L Duramax

AP63563



Water Pump

OEM Part Numbers: 98031233, 251–738, 12637105

Notes: Includes mounting gaskets.

Year Range:
2006–2014

Engine:
6.6 L Duramax

Electrical Harness and Repair

AP0068



2 Wire Pigtail

Notes: Fits the VGT Solenoid.

Year Range:
2004½–2012

Engine:
6.6 L LLY, LBZ, LMM, LML, LGH Duramax

Seal and Gasket Kits

AP0029



Fuel Filter Base and Hand Primer Seal Kit

Year Range:
2001–2010

Engine:
6.6 L Duramax

6.6 L DURAMAX

Seal and Gasket Kits *continued***Head Installation Kit****AP0045****Notes:** Head Gaskets sold separately refer to AP0047–AP0052.**Year Range:** 2001–2004½
Engine: 6.6 L LB7 Duramax**Kit Contents:**

- 2 Lower Valve Cover Gaskets
- 1 Exhaust Manifold Gasket Kit
- 1 Intake Manifold Gasket Kit
- 2 Thermostat Housing to Head Gaskets
- 1 Exhaust Gas Recirculation (EGR) System Gasket Kit
- 1 Water Pump to Outlet Pipe Gasket
- 1 Fuel Return Line Kit
- 16 Injector Cup Seals
- 1 Turbo Inlet Gasket
- 1 Coolant Bypass Pipe Seal Kit
- 1 Thermostat Housing to Coolant Outlet Pipe Seal
- 1 Thermostat Housing to Heater Pipe Seal
- 2 Fuel Injection Control Module (FICM) Banjo Seals
- 1 Head Stud Kit

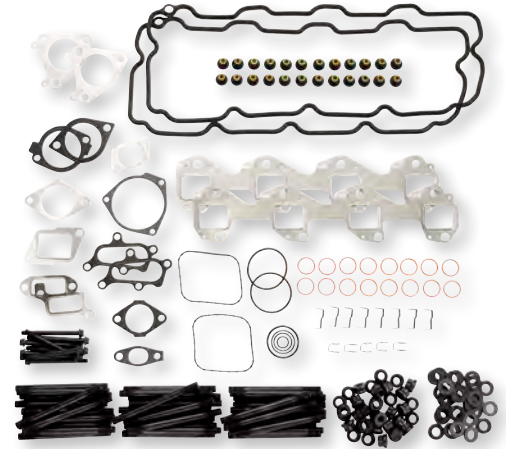
**Head Installation Kit****AP0046****Notes:** Head Gaskets sold separately refer to AP0047–AP0052.**Year Range:** 2004½–2010
Engine: 6.6 L LLY, LBZ, LMM Duramax**Kit Contents:**

- 2 Upper Valve Cover Gaskets
- 2 Lower Valve Cover Gaskets
- 1 Exhaust Manifold Gasket Kit
- 1 Intake Manifold Gasket Kit
- 2 Thermostat Housing to Head Gaskets
- 1 Exhaust Gas Recirculation (EGR) System Gasket Kit
- 1 Water Pump to Outlet Pipe Gasket
- 1 Coolant Bypass Pipe Seal Kit
- 1 Thermostat Housing to Coolant Outlet Pipe Seal
- 1 Thermostat Housing to Exhaust Gas Recirculation (EGR) Cooler Pipe Seal
- 2 Fuel Injection Control Module (FICM) Banjo Seals
- 1 Head Stud Kit

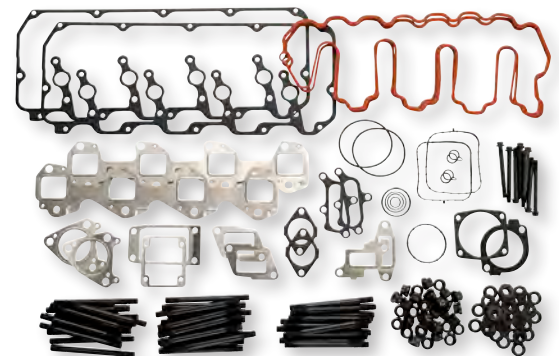

***For the Most Up-To-Date
Product Information Visit
alliantpower.com***

6.6 L DURAMAX

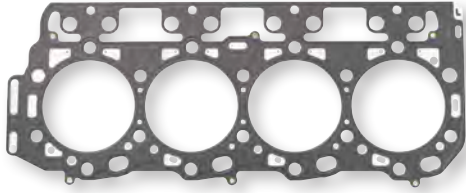
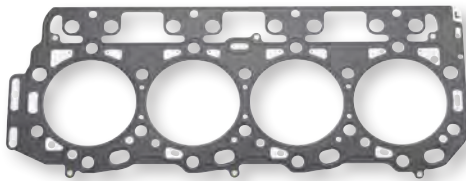
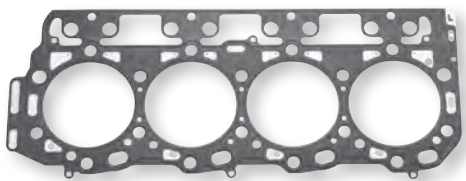
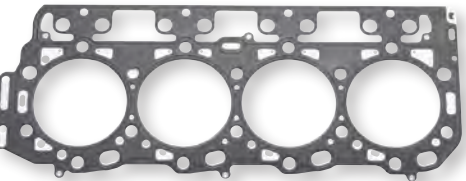
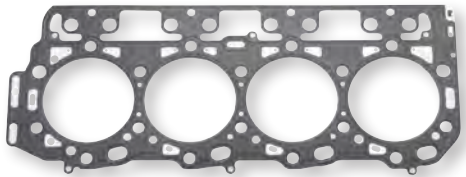
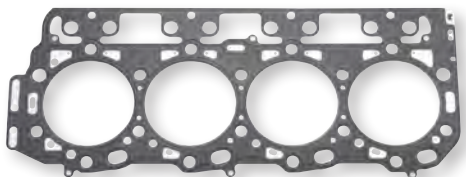
Seal and Gasket Kits *continued***AP0047****Head Gasket****OEM Part Number:** 98045058**Notes:** 0.95 mm, Grade A, left.**Year Range:**
2001–2010**Engine:**
6.6 L Duramax**AP0048****Head Gasket****OEM Part Number:** 98045059**Notes:** 1.00 mm, Grade B, left.**Year Range:**
2001–2010**Engine:**
6.6 L Duramax**AP0049****Head Gasket****OEM Part Number:** 98045060**Notes:** 1.05 mm, Grade C, left.**Year Range:**
2001–2010**Engine:**
6.6 L Duramax**AP0050****Head Gasket****OEM Part Number:** 98045055**Notes:** 0.95 mm, Grade A, right.**Year Range:**
2001–2010**Engine:**
6.6 L Duramax**AP0051****Head Gasket****OEM Part Number:** 98045056**Notes:** 1.00 mm, Grade B, right.**Year Range:**
2001–2010**Engine:**
6.6 L Duramax**AP0052****Head Gasket****OEM Part Number:** 98045057**Notes:** 1.05 mm, Grade C, right.**Year Range:**
2001–2010**Engine:**
6.6 L Duramax

6.6 L DURAMAX

Engine Accessories

Belt Tensioner

OEM Part Numbers: 97329062, 38172, 8900343, 98094201

Year Range: 2002–2014
Engine: 6.6 L Duramax



Remanufactured Starter

OEM Part Numbers: 88864234, 336–1737

Year Range: 2003–2011
Engine: 6.6 L Duramax



Filters

Spin-on Fuel Filter (Racor)

OEM Part Numbers: 98017645, TP1298B

Year Range: 2001–2011
Engine: 6.6 L Duramax
Application: Silverado and Sierra Vehicles



Fuel Filter Service Kit (Racor)

Notes: Primary and secondary.

Year Range: 2005–2011
Engine: 6.6 L Duramax
Application: Express and Savana Vehicles



Drain Valve/Water Sensor Kit (Racor)

Year Range: 2001–2011
Engine: 6.6 L Duramax





DODGE/CUMMINS



DODGE/CUMMINS

ENGINES WITH PT PUMPS

Fuel System Components

AP3035342



Fuel Shut-off Valve Assembly-12 Volt

OEM Part Number: 3035342

Year Range: N/A Application: PT Pumps

AP3035344

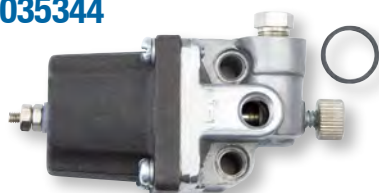

Fuel Shut-off Valve Assembly-24 Volt

OEM Part Number: 3035344

Year Range: N/A Application: PT Pumps

AP4024808



Fuel Shut-off Coil-12 Volt

OEM Part Number: 4024808

Year Range: N/A Application: PT Pumps

AP4024809



Fuel Shut-off Coil-24 Volt

OEM Part Number: 4024809

Year Range: N/A Application: PT Pumps

***Visit alliantpower.com
For Additional Information
Such as Technical Bulletins and
New Product Announcements***

Fuel System Components

Fuel Transfer Pump

OEM Part Numbers: 3901425, 3904374, 3928143, 3966154, 3970880, 4983584

Year Range:
1989–1993

Application:
5.9 L B-Series, 12-Valve

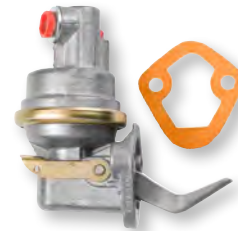

AP63478

Fuel Transfer Pump Kit

OEM Part Numbers: 3936316, 4988747, 4944710

Notes: Includes two mounting gaskets.

Year Range:
1994–1998

Application:
5.9 L B-Series, 12-Valve

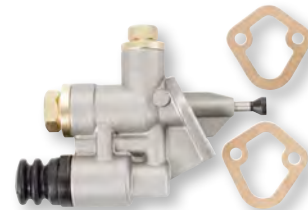

AP4988747

Fuel Transfer Pump Kit

OEM Part Numbers: 3990082, 3990105, 4932707, 4935730

Year Range:
1998–2003

Application:
5.9 L ISB with VP44



AP4943048

Fuel Transfer Pump Kit

OEM Part Number: 3969705 (Hose)

Year Range:
2003–2004

Application:
5.9 L ISB with Common Rail



AP4089602

Engine Components

Oil Cooler

OEM Part Numbers: 3921558, 3957544, 4713985AB

Year Range:
1993–1998
1998–2003

Application:
5.9 L B-Series, 12-Valve
5.9 L ISB with VP44

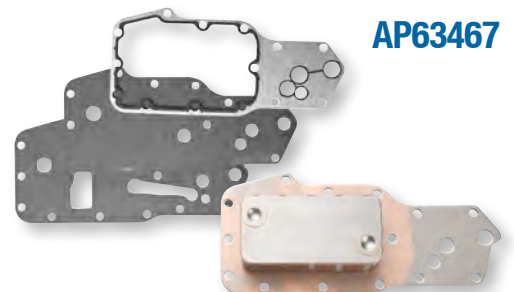

AP63467

DODGE/CUMMINS

5.9 L

Engine Components *continued*

AP63531



Water Pump

OEM Part Numbers: 3286278, 3286277

Notes: Includes mounting gasket. Supersedes AP63530 Water Pump.

Year Range:

1990–1998

1998–2003

Application:

5.9 L B-Series, 12-Valve

5.9 L ISB with VP44

AP63532

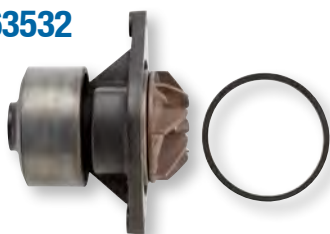

Water Pump

OEM Part Numbers: 3800984, 4891252

Notes: Includes mounting gasket.

Year Range:

2003–2007

Application:

5.9 L ISB with Common Rail

Sensors

AP63428



Accelerator Pedal Position Sensor (APPS)

OEM Part Numbers: 3970084, 53031575AH

Notes: For use with automatic transmissions.

Year Range:

1998–2003

Application:

5.9 L ISB with VP44

AP63427



Accelerator Pedal Position Sensor (APPS)

OEM Part Numbers: 3970085, 53031576AD

Notes: For use with manual transmissions.

Year Range:

1998–2003

Application:

5.9 L ISB with VP44

AP63458



Accelerator Pedal Position Sensor (APPS)

Notes: For use with automatic or manual transmissions.

Year Range:

1998–2003

2003–2004

Application:

5.9 L ISB with VP44

5.9 L ISB with Common Rail

Sensors *continued*

Crankshaft Position (CKP) Sensor

OEM Part Number: 4921601

Year Range: 1998–2003
Application: 5.9 L ISB with VP44



AP63453

Seal and Gasket Kits

Valve Cover Gasket

OEM Part Numbers: 3935878, 5016356AB

Year Range: 1998–2003
Application: 5.9 L ISB with VP44



AP0012

Intake Grid Heater Gasket

OEM Part Number: 3969988

Year Range: 1989–1998
1998–2003
2003–2006
Application: 5.9 L B-Series, 12-Valve
5.9 L ISB with VP44
5.9 L ISB with Common Rail



AP0058

Head Gasket Kit

Notes: Standard head gasket.

Year Range: 1998–2003
Application: 5.9 L ISB with VP44

Kit Contents:

- 1 Head Gasket
- 1 Valve Cover Gasket
- 6 Exhaust Manifold Gaskets
- 1 Intake Manifold Gasket Set
- 1 Turbo Gasket Set
- 1 Coolant Outlet Gasket
- 1 Head Stud Kit

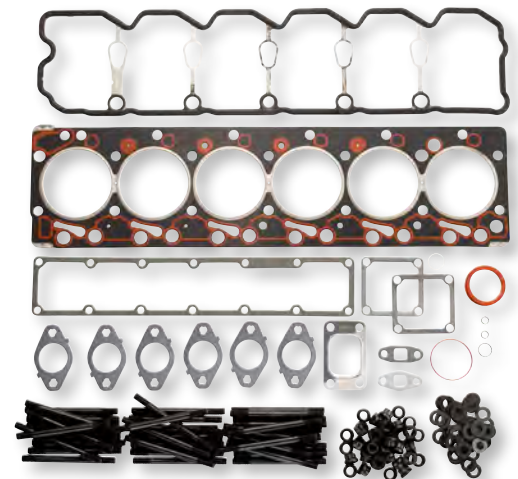

AP0053

DODGE/CUMMINS

5.9 L

Seal and Gasket Kits *continued*

AP0054

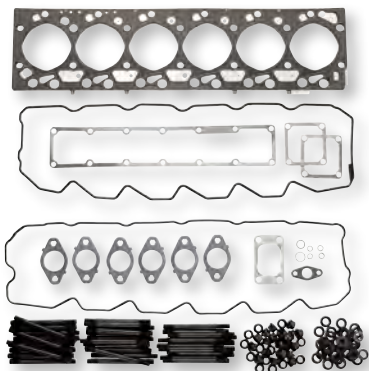

Head Gasket Kit

Notes: 1.10 mm head gasket.

Year Range:
2003–2006

Application:

5.9 L ISB with Common Rail

Kit Contents:

- 1 Head Gasket
- 1 Valve Cover Gasket
- 1 Rocker Housing Gasket
- 6 Exhaust Manifold Gaskets
- 1 Intake Manifold Gasket Set
- 1 Turbo Gasket Set
- 1 Head Stud Kit

AP0055

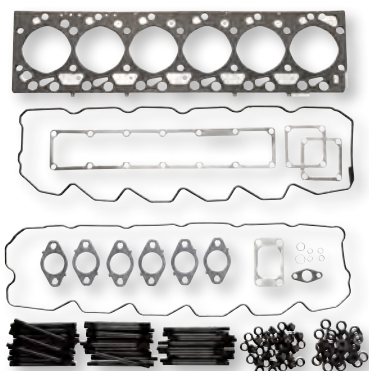

Head Gasket Kit

Notes: 1.20 mm head gasket.

Year Range:
2003–2006

Application:

5.9 L ISB with Common Rail

Kit Contents:

- 1 Head Gasket
- 1 Valve Cover Gasket
- 1 Rocker Housing Gasket
- 6 Exhaust Manifold Gaskets
- 1 Intake Manifold Gasket Set
- 1 Turbo Gasket Set
- 1 Head Stud Kit

Engine Accessories

228000–2292



Starter

OEM Part Numbers: 3921682, 5016522AA

Year Range:
1994–1998
1998–2002

Application:

5.9 L B-Series, 12-Valve
5.9 L ISB with VP44

428000–5940



Starter

OEM Part Numbers: 4090084, 5086932AA

Year Range:
2003–2006

Application:

5.9 L ISB with Common Rail

Engine Components

Water Pump

OEM Part Numbers: 2881804, 68003402AA, 4955359

Notes: Includes mounting gasket.

Year Range:
2007–2012

Application:
6.7 L ISB

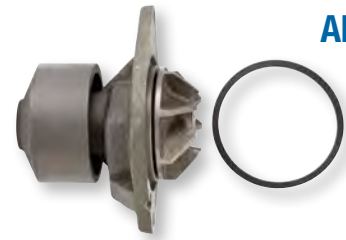

AP63533

*All Alliant Power Products
are Backed with a 13–Month
Unlimited Mileage Warranty*



SPRINTER/JEEP

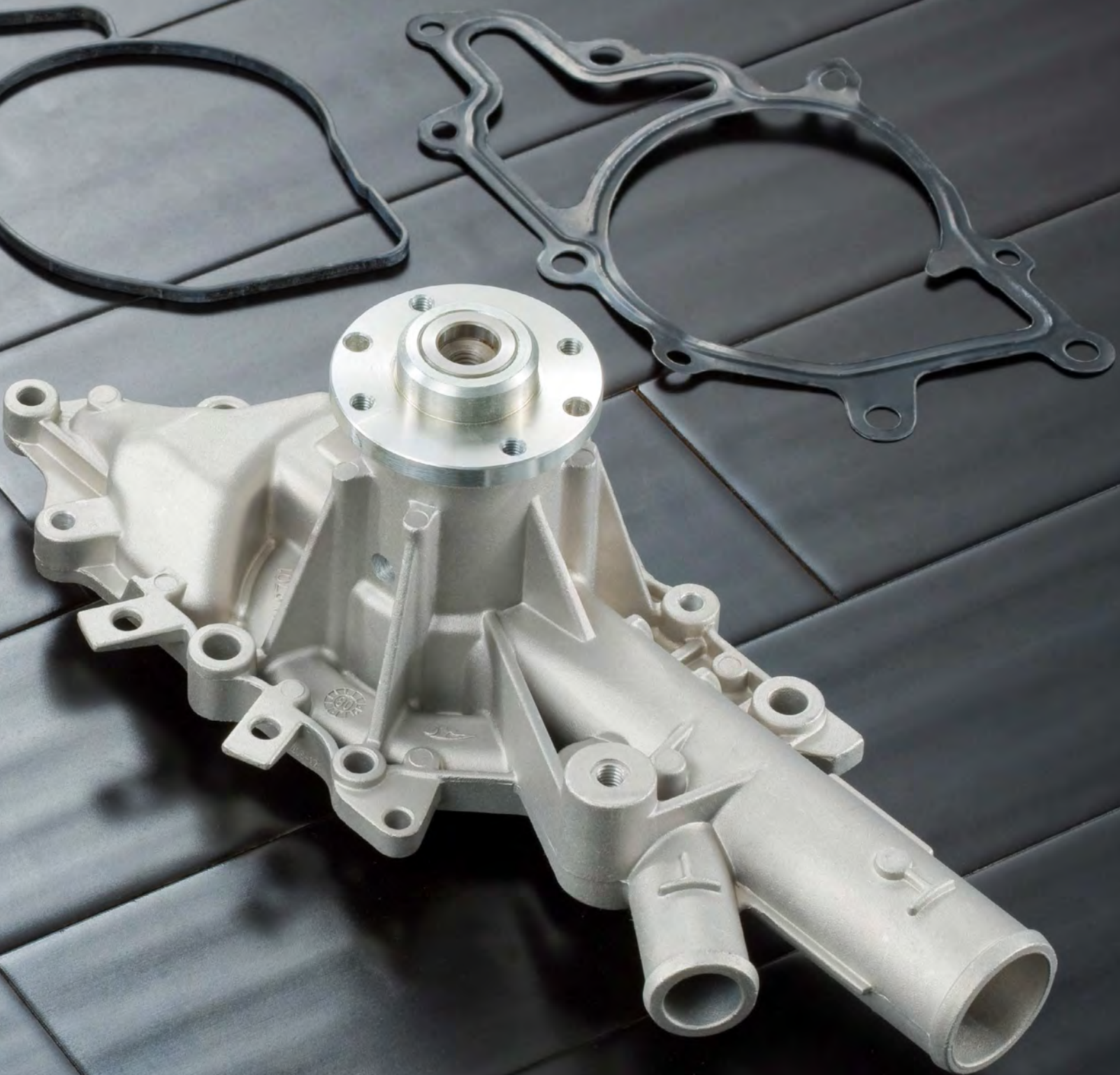

SPRINTER/JEEP

2.7 L AND 3.0 L

Engine Components

AP63600



Water Pump

OEM Part Numbers: 5103576AA, 6112001101

Notes: Includes two mounting gaskets.

Year Range:
2002–2003

Engine:
2.7 L OM 612

Application:
Sprinter 2500 / 3500

AP63601



Water Pump

OEM Part Numbers: 5138057AA, 6472000101

Notes: Includes mounting gasket.

Year Range:
2004–2006

Engine:
2.7 L OM 647

Application:
Sprinter 2500 / 3500

Filters

AP61000

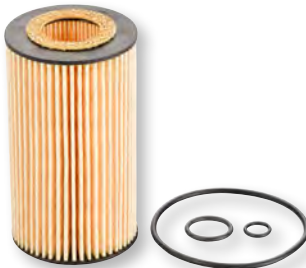

Oil Filter Element Service Kit

OEM Part Numbers: 0011849425, 5086301AA, 1121840025, 6111800009, A6111800009

Year Range:
2002–2003
2004–2006

Engine:
2.7 L OM 612
2.7 L OM 647

Application:
Sprinter 2500 / 3500
Sprinter 2500 / 3500

AP61001

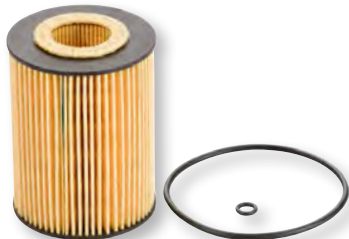

Oil Filter Element Service Kit

OEM Part Numbers: 5175571AA, 6421800009, A6421800009

Year Range:
2007–2014
2007–2008

Engine:
3.0 L OM 642
3.0 L OM 642

Application:
Sprinter 2500 / 3500
Jeep Grand Cherokee

SPRINTER/JEEP

2.7 L AND 3.0 L

Filters *continued*

Fuel Filter without WIF Sensor

OEM Part Numbers: 5103577AA, 6120920001, A6120920001

Notes: WIF sensor can be transferred from old filter to new filter.

Year Range:	Engine:	Application:
2002–2003	2.7 L OM 612	Sprinter 2500 / 3500



AP61002

Fuel Filter without WIF Sensor

OEM Part Numbers: 5117492AA, 5170896AB, 5175425AB, 5175429AB, 6460920701, 6460900252, 6460920201, 6460920601

Notes: WIF sensor can be transferred from old filter to new filter.

Year Range:	Engine:	Application:
2004–2006	2.7 L OM 647	Sprinter 2500 / 3500
2007–2009	3.0 L OM 642	Sprinter 2500 / 3500
2007–2008	3.0 L OM 642	Jeep Grand Cherokee



AP61003

Fuel Filter without WIF Sensor

OEM Part Number: 6420920301

Notes: WIF sensor can be transferred from old filter to new filter.

Year Range:	Engine:	Application:
2010–2012	3.0 L OM 642	Sprinter 2500 / 3500



AP61005

*Visit alliantpower.com
to Find Your Nearest
Service Dealer*



TOOLS



Ford / Navistar

AP0017



G2.8 Injector Connector Removal Tool

Notes: Used for the removal of the Remanufactured G2.8 Injector (AP60900 and AP60901) from the engine.

Year Range:

2003–2007
2004–2010
2006–2010
2003–2007
2006
2007–2010

Application:

F Series, Excursion
E Series
4.5 L LCF
VT365
VT275
MaxxForce 5

AP0069



High-Pressure Oil Rail Socket

Notes: Required for installation of AP0070 High-Pressure Oil Rail Seal Kit.

Year Range:

2003–2007
2004–2010
2006–2010
2003–2007
2006
2007–2010

Application:

F Series, Excursion
E Series
4.5 L LCF
VT365
VT275
MaxxForce 5

AP0037



Pressure Test Kit

Notes: Used to test low-pressure fuel and oil systems. Also used to perform a leak test on high-pressure oil systems.

Year Range:

1994–2003
2003–2007
2004–2010
2006–2010
1994–2004
2003–2007
2006
2007–2010

Application:

F Series, Excursion, E Series
F Series, Excursion
E Series
4.5 L LCF
T444E
VT365
VT275
MaxxForce 5



OEM PART NUMBER CROSS REFERENCE

OEM Part Number	AP Part Number	Page(s)	OEM Part Number	AP Part Number	Page(s)
0 580 464 074.....	G9136.....	5	1824473C2	AP63802AC.....	38
0011849425.....	AP61000.....	96	1824474C2	AP63802AC.....	38
1121840025.....	AP61000.....	96	1824582C94	AP63801AB.....	38
12085499	AP0022.....	79	1824583C97	AP63801AB.....	38
12496472.....	AP63420.....	79	1824739C1	AP63806BB	60
12530176	AP63560.....	78	1824740C1	AP63807BC	60
12555492.....	AP63419.....	79	1824741C2	AP63808BD	60, 66
12556231.....	AP63561.....	78	1824742C91	AP63806BB	60
12557046.....	AP63444.....	79	1824743C91	AP63807BC	60
12637105.....	AP63563.....	82	1824744C94	AP63808BD	60, 66
15019994.....	AP63457.....	82	1824839C94	AP63809BE.....	60
15019995.....	AP63457.....	82	1824908C1	AP63464.....	64
15161174.....	AP63442.....	81	1824917C2	AP63805BA.....	60, 66
15320904.....	AP0067.....	80	1824918C2	AP63806BB	60
15754298.....	AP63441.....	78	1824919C2	AP63807BC	60
15821962.....	AP63442.....	81	1824920C2	AP63808BD	60, 66
1807329C92	AP63418.....	41	1824928C94	AP63805BA.....	60, 66
1807369C2	AP63466.....	63	1824929C94	AP63806BB	60
1814376C1	AP63411.....	39	1824930C94	AP63807BC	60
1815904C2	AP63452.....	39, 62	1824931C94	AP63808BD	60, 66
1815923C92	AP63414.....	43	1824982C91	AP63401.....	41, 63
1816187C3	AP63800AA.....	38	1825125C1	AP63801AB.....	38
1817687C92	AP63580.....	62	1825126C1	AP63801AB.....	38
1818259C2	AP63800AA.....	38	1825186C91	AP63409.....	39
1818350C2	AP0013.....	44	1825247C91	HP004X.....	40
1818778C3	AP63434.....	62	1825248C91	HP005X.....	40
181934C1	AP63805BA.....	60, 66	1825259C91	HP005X.....	40
1819834C1	AP63805BA.....	60, 66	1825260C91	HP004X.....	40
1820909C1	AP0036.....	65	1825271C93	HP004X.....	40
1821752C1	AP63800AA.....	38	1825602C91	AP0036.....	65
1821836C3	AP63800AA.....	38	1825681C95	HP021X.....	62
1821935C3	AP63580.....	62	1825806C91	AP0003.....	43, 64
1822631C91	PFF4595	44	1825899C93	AP63400.....	40
1822800C95	AP63800AA.....	38	1826458C92	HP022X.....	62
1822801C91	AP63800AA.....	38	1826634C94	AP63405.....	41
1822803C1	AP63801AB.....	38	1826703C1	AP0014.....	44
1822890C1	AP63802AC.....	38	1826794C93	APM61067.....	39
1823561C1	AP63801AB.....	38	1828345C91	AP63412.....	47, 56, 72
1823736C94	AP63805BA.....	60, 66	1829336C1	AP63809BE.....	60
1823751C91	AP63803AD	38	1829837C2	AP63809BE.....	60
1824415C93	APM61067.....	39	1829838C94	AP63809BE.....	60
1824455C94	AP63802AC.....	38	1829839C93	AP63809BE.....	60
1824456C96	AP63802AC.....	38	1829856C91	AP63402.....	41, 63
1824472C1	AP63802AC.....	38	1829926C2	AP63809BE.....	60

OEM PART NUMBER CROSS REFERENCE

OEM Part Number	AP Part Number	Page(s)	OEM Part Number	AP Part Number	Page(s)
1830094C92	AP63812BJ	61, 66	1832094C92	AP63685, AP63687	71
1830145C91	AP63810BF	60, 66	1832095C2	AP63685, AP63687	71
1830146C94	AP63810BF	60, 66	1833564C92	AP0001	43, 64, 67
1830147C2	AP63810BF	60, 66	1833639C1	AP63804AE	38
1830148C2	AP63810BF	60, 66	1833640C1	AP63804AE	38
1830155C91	BG	61	1833644C1	AP63804AE	38
1830156C91	BG	61	1833645C1	AP63804AE	38
1830157C1	BG	61	1833646C92	AP63804AE	38
1830158C1	BG	61	1833647C91	AP63804AE	38
1830177C92	HP020X	62	1833798C91	AP63401	41, 63
1830317C1	AP0006	65, 74	1835985C92	AP63415	47, 56, 72
1830559C91	AP63811BI	61, 66	1836250C1	AP63814BP	61, 67
1830560C2	AP63811BI	61, 66	1836251C91	AP63814BP	61, 67
1830561C92	AP63811BI	61, 66	1836252C91	AP63814BP	61, 67
1830562C2	AP63811BI	61, 66	1836253C1	AP63814BP	61, 67
1830570C91	BG	61	1836412C91	AP63402	41, 63
1830570C92	AP63812BJ	61, 66	1836537C91	AP63437	48, 57, 72
1830571C2	AP63812BJ	61, 66	1836539C91	AP63462	49, 72
1830572C93	AP63812BJ	61, 66	1838250C1	AP0023	52
1830573C2	AP63812BJ	61, 66	1838828C91	HP032X	47
1830573C2	BG	61	1839437C95	AP63416	50
1830606C94	AP63580	62	1840078C1	AP63429	63
1830669C92	AP63465	63	1840702C97	AP63447	53
1830691C1	AP63813BN	61, 67	1840754C91	RK31821	54, 59
1830692C91	AP63813BN	61, 67	1840778C91	AP0005	52
1830693C1	AP63813BN	61, 67	1840903C91	AP63479	50
1830694C93	AP63813BN	61, 67	1841086C91	AP63402	41, 63
1830740C92	AP63811BI	61, 66	1841217C91	AP63402	41, 63
1830741C92	AP63811BI	61, 66	1841279C91	AP63401	41, 63
1830844C93	AP63413	43	1841491C91	AP66976	68
1830857C91	HP007X	40	1842223C91	AP66976	68
1831196C92	AP63410	39, 45	1842224C91	AP66977	68
1831259C91	AP63435	48	1842225C91	AP66978	68
1831449C91	HP008X	40	1842226C91	AP66979	68
1831487C92	AP63803AD	38	1842423C97	AP63682	70
1831488C1	AP63803AD	38	1842424C2	AP63682	70
1831489C12	AP63803AD	38	1842425C96	AP63683	70
1831550C14	AP63803AD	38	1842426C2	AP63683	70
1831551C13	AP63803AD	38	1842576C93	AP66976	68
1831646C1	AP63405	41	1842577C93	AP66977	68
1831658C91	AP63461	44	1842578C94	AP66978	68
1831676C92	AP63581	39	1842579C94	AP66979	68
1832092C92	AP63684, AP63686	71	1842614C91	AP63682	70
1832093C2	AP63684, AP63686	71	1842617C91	AP63683	70

OEM PART NUMBER CROSS REFERENCE

OEM Part Number	AP Part Number	Page(s)	OEM Part Number	AP Part Number	Page(s)
1842624C92	AP0026	74	1876106C94	AP63685	71
1842626C95	AP0025	74	1876529C98	AP63641	55
1842664C92	AP63582	70	1876735C91	AP63400	40
1842665C93	AP63582	70	1877748C1	AP60901	45
1842721C91	HP021X	62	1878281C92	AP60900	45
1842722C91	HP020X	62	1878282C91	AP60900	45
1842723C91	HP022X	62	1878284C91	AP60901	45
1843057C92	PFF31795	54	1878285C91	AP60901	45
1843089C91	AP60900	45	1878865C91	AP63661	46
1843481C95	AP60900	45	1879743C93	AP63684, AP63686	71
1843682C91	AP0002	52	1879744C2	AP63684, AP63686	71
1844751C2	AP60901	45	1879745C93	AP63687	71
1845002C91	AP63583	46	1879747C2	AP63687	71
1845145C99	AP63446	46	1879998C91	AP60901	45
1845150C92	AP60901	45	1880313C94	AP63663	47
1845274C92	AP63407	48	1882258C93	AP63686	71
1845428C92	AP63460	49	1882259C93	AP63685, AP63687	71
1845427C2	AP63460	49	1882919C92	AP63661	46
1845879C91	AP60900	45	1883110C1	AP64901	55
1845988C1	AP63470	57	1883111C92	AP64901	55
1846057C1	AP63417	50	1883888C93	AP63682	70
1846296C91	AP63459	50	1884057C92	AP66857	69
1846480C2	AP63423	48, 56, 72	1884058C2	AP66857	69
1846481C92	AP63476	49, 57, 73	1884357C92	AP63662	47
1846491C91	AP63438	50	1885000C93	AP63683	70
1846692C92	AP60901	45	1885043C92	AP63680	70
1847321C1	AP0042	58	1885044C2	AP63680	70
1848489C91	AP66989	68	1885045C92	AP63681	70
1848492C91	AP66992	68	1885046C2	AP63681	70
1848495C91	AP66995	69	1885819C92	AP63456	58
1848718C92	AP66918	69	1886511C93	AP63451	46
1848721C92	AP66921	69	1886547C1	AP0027	58
1850352C2	AP63408	48	1888560C1	AP63471	57, 72
1850353C1	AP63403	41, 48	1888696C93	AP0035	53
1855644C3	AP0027	58	1889249C91	AP63581	39
1855860C94	AP63641	55	1889323C93	AP63680	70
1858088C92	AP0057	53	1889324C92	AP63681	70
1871291C4	AP63682	70	1889905C91	AP63464	64
1871292C96	AP63682	70	1890055C92	AP66855	69
1873400C92	AP63422	56	1890056C2	AP66855	69
1873422C93	AP64900	55	1890057C92	AP66858	69
1873425C93	AP0027	58	1890058C2	AP66858	69
1875838C91	AP63463	49, 57	1899239C92	AP64901	55
1876105C95	AP63684	71	19113733	AP63562	82

OEM PART NUMBER CROSS REFERENCE

OEM Part Number	AP Part Number	Page(s)	OEM Part Number	AP Part Number	Page(s)
19168610.....	AP63560.....	78	3286278.....	AP63531.....	90
19168888.....	AP63562.....	82	336-1737.....	S14-101DAM.....	85
1997227.....	AP63443.....	79	38172.....	AP63449.....	85
1C3Z6A642AA.....	AP63452.....	6	3800984.....	AP63532.....	90
1C3Z6C610BA.....	AP0004.....	10	3901425.....	AP63478.....	89
1C3Z6K649BA.....	AP0004.....	10	3904374.....	AP63478.....	89
1C3Z9D477AA.....	AP63404.....	6	3921558.....	AP63467.....	89
1C3Z9J460AA.....	AP63429.....	8	3921682.....	228000-2292.....	92
212-366.....	AP63420.....	79	3928143.....	AP63478.....	89
213-337.....	AP63444.....	79	3935878.....	AP0012.....	91
214-1073.....	AP63443.....	79	3936316.....	AP4988747.....	89
215-115.....	AP63701.....	80	3957544.....	AP63467.....	89
215-479.....	AP63702.....	80	3966154.....	AP63478.....	89
251-590.....	AP63560.....	78	3969705 (Hose).....	AP4089602.....	89
251-603.....	AP63561.....	78	3969988.....	AP0058.....	91
251-674.....	AP63562.....	82	3970084.....	AP63428.....	90
251-723.....	AP63562.....	82	3970085.....	AP63427.....	90
251-738.....	AP63563.....	82	3970880.....	AP63478.....	89
252-776.....	AP63561.....	78	3990082.....	AP4943048.....	89
252-838.....	AP63562.....	82	3990105.....	AP4943048.....	89
2503701C91.....	HP004X.....	40	3C3U11000AB.....	AP83006.....	26
2503703C91.....	HP005X.....	40	3C2Z6B209AA.....	AP63448.....	25
2503704C91.....	HP007X.....	40	3C2Z6B209BA.....	AP63432.....	25
25117340.....	AP63440.....	78	3C3Z10884AA.....	AP63437.....	18, 30
2589446C91.....	HP008X.....	40	3C3Z11002AA.....	AP83006.....	26
2593588C91.....	AP63805BA.....	60, 66	3C3Z12A697AA.....	AP63462.....	19
2593589C91.....	AP63806BB.....	60	3C3Z12K073AA.....	AP63415.....	18, 29
2593590C91.....	AP63807BC.....	60	3C3Z6584BA.....	AP0023.....	23
2593591C91.....	AP63808BD.....	60, 66	3C3Z6766CA.....	RK31821.....	27, 34
2593592C91.....	AP63809BE.....	60	3C3Z6A642CA.....	AP63451.....	16
2593593C91.....	AP63810BF.....	60, 66	3C3Z6C315AA.....	AP63412.....	18, 29
2593594C91.....	AP63811BI.....	61, 66	3C3Z8501A.....	AP63502.....	16
2593595C91.....	AP63811BI.....	61, 66	3C3Z9229AA.....	AP0002.....	22
2593596C91.....	AP63812BJ.....	61, 66	3C3Z9433BE.....	AP63447.....	25
2593596C91.....	BG.....	61	3C3Z9A543AARM.....	HP032X.....	17
2593597C91.....	AP63813BN.....	61, 67	3C3Z9C407AB.....	AP63426.....	26
2881804.....	AP63533.....	93	3C3Z9C968AA.....	AP63416.....	20
2C3Z8V501BA.....	AP63501.....	6	3C3Z9E527ABRM.....	AP60900.....	14
2C3Z9C968BA.....	AP63401.....	8	3C3Z9E527AE.....	AP60900.....	14
2C3Z9G804AB.....	AP0011.....	11	3C3Z9E527EARM.....	AP60900.....	14
3035342.....	AP3035342.....	88	3C3Z9E527EARM.....	AP60900.....	14
3035344.....	AP3035344.....	88	3C3Z9E527ECRM.....	AP60900.....	14
30360R1.....	AP63464.....	64	3C3Z9F838EA.....	AP63407.....	19
3286277.....	AP63531.....	90	3C3Z9G270AA.....	PFF31795.....	26

OEM PART NUMBER CROSS REFERENCE

OEM Part Number	AP Part Number	Page(s)	OEM Part Number	AP Part Number	Page(s)
3C3Z9H529A	AP0035	23	5010659R92	AP66979	68
3C3Z9P455AB	AP0005	23	5016356AB	AP0012	91
4024808	AP4024808	88	5016522AA	228000-2292	92
4024809	AP4024809	88	5086301AA	AP61000	96
4090084	428000-5940	92	5086932AA	428000-5940	92
4307212R91	AP66921	69	5103576AA	AP63600	96
4307291R91	AP63641	55	5103577AA	AP61002	97
4307325R91	AP63662	47	5117492AA	AP61003	97
4307327R91	AP63663	47	5138057AA	AP63601	96
4307369R91	AP64900	55	5170896AB	AP61003	97
4307381R91	AP64900	55	5175425AB	AP61003	97
4713985AB	AP63467	89	5175429AB	AP61003	97
4891252	AP63532	90	5175571AA	AP61001	96
4921601	AP63453	91	53031575AH	AP63428	90
4932707	AP4943048	89	53031576AD	AP63427	90
4935730	AP4943048	89	5C3Z12224A	AP0021	9, 20, 31
4944710	AP4988747	89	5C3Z9A543ARM	AP63661	17
4955359	AP63533	93	5C3Z9A543C	AP63661	17
4983584	AP63478	89	5C3Z9C968CA	AP63417	20
4988747	AP4988747	89	5C3Z9F452AA	AP63439	20
4C2Z2A451AA	AP63703	25	5C3Z9J460A	AP63408	18
4C2Z6766BA	RK32138	27	5C3Z9J460B	AP63408	18
4C3Z12B599AB	AP65122, AP65123, AP65124	15	5C3Z9VE527ARM	AP63804AE	4
4C3Z12B599ABRM	AP65122, AP65123, AP65124	15	5C3Z9VE527BRM	AP63803AD	4
4C3Z2A451BA	AP63433	12, 25	5C4Z9A543A	AP63661	17
4C3Z8501AC	AP63503	16	5C4Z9A543B	AP63661	17
4C3Z8A616AA	AP63430	25	6111800009	AP61000	96
4C3Z9A543AARM	HP032X	17	6112001101	AP63600	96
4C3Z9E527AA	AP60901	14	6120920001	AP61002	97
4C3Z9E527BRM	AP60901	14	6420920301	AP61005	97
4C3Z9F452A	AP63438	20	6421800009	AP61001	96
4C3Z9F838A	AP63460	19	6460900252	AP61003	97
4C3Z9F838AB	AP63460	19	6460920201	AP61003	97
4C3Z9J460A	AP63403	8, 18	6460920601	AP61003	97
4C3Z9P456AC	AP63446	15	6460920701	AP61003	97
4C3Z9P456AF	AP63446	15	6472000101	AP63601	96
4C3Z9P456AH	AP63446	15	68003402AA	AP63533	93
4C3Z9P456AJ	AP63446	15	6C2Z9G282AA	AP63431	26
5010118R91	AP63503	46	6C3A2A451BA	AP63433	12, 25
5010359R93	AP64900	55	6C3Z2A451A	AP63433	12, 25
5010561R91	AP66918	69	6C3Z6C640A	AP63454	16
5010656R92	AP66976	68	6C3Z6C640C	AP63455	16
5010657R92	AP66977	68	6C3Z9C407AA	AP63426	26
5010658R92	AP66978	68	6C3Z9G282AA	AP63426	26

OEM PART NUMBER CROSS REFERENCE

OEM Part Number	AP Part Number	Page(s)	OEM Part Number	AP Part Number	Page(s)
6C3Z9G282C	AP63431	26	98045058	AP0047	84
6E7Z9A543BRM	AP63662	17	98045059	AP0048	84
7080839C92	AP63642	55	98045060	AP0049	84
7081021C1	AP63480	56	98094201	AP63449	85
7849209	AP63701	80	9C2Z9G282A	AP63431	26
7C3Z11002AA	AP83007	33	A6111800009	AP61000	96
7C3Z12B579A	AP63475	31	A6120920001	AP61002	97
7C3Z8B552A	AP63472	28	A6421800009	AP61001	96
88864234	S14-101DAM	85	AFLS179	AP63475	31
88894035	AP63561	78	BC3Z9N184B	AP61004	35
88894036	AP63560	78	BRPV-1	AP63703	25
8900343	AP63449	85	BRPV-6	AP63700	12
89017558	AP63702	80	BRPV-7	AP63433	12, 25
8C349F479AA	AP63476	31	BT50	AP63421	11
8C3Z12A697B	AP63463	19, 30	CM5054	AP63416	20
8C3Z12B591A	AP63470	30	CM5055	AP0002	22
8C3Z12B591E	AP63471	30	CM5126	AP63417	20
8C3Z12K073A	AP63415	18, 29	CX2020	AP63439	20
8C3Z8501B	AP63504	28	CX2056	AP63438	20
8C3Z9229A	AP0027	32	CX2161	AP63476	31
8C3Z9A543B	AP63640	29	CX2466RM	AP63439	20
8C3Z9A543DRM	AP63640	29	CX2467RM	AP63438	20
8C3Z9D475D	AP63456	31	D1808A	AP63419	79
8C3Z9D476A	AP0042	32	DPFE1	AP63429	8
8C3Z9E527A	AP64900	28	DPFE3	AP63403	8, 18
8C3Z9E527DRM	AP64900	28	DPFE6	AP63408	18
8C3Z9F479A	AP63476	31	DPFE8	AP63423	29
8C3Z9G282A	AP63450	33	DPFE17	AP63473	30
8C3Z9G756A	AP63422	29	DU88	AP63415	18, 29
8C3Z9J460A	AP63423	29	DY1112	AP63463	19, 30
8C3Z9J460D	AP63473	30	DY1144	AP63436	7
8E7Z9A543CRM	AP63663	17	DY861	AP63405	8
97188720	AP63720	81	DY876	AP63406	4, 14, 28
97188721	AP63721	81	DY961	AP63436	7
97188722	AP63722	81	DY984	AP63462	19
97188723	AP63723	81	DY985	AP63412	18, 29
97216136	AP63562	82	EP1000	AP63441	78
97228929	AP0059	81	EP1001	AP63442	81
97329062	AP63449	85	EP1020	AP63442	81
98017645	PPF50216	85	EP309	AP63440	78
98031233	AP63563	82	F4TZ11002A	AP83000	12
98045055	AP0050	84	F4TZ6584A	AP0013	11
98045056	AP0051	84	F4TZ6A636A	AP0004	10
98045057	AP0052	84	F4TZ9A543BRM	HP004X	6

OEM PART NUMBER CROSS REFERENCE

OEM Part Number	AP Part Number	Page(s)	OEM Part Number	AP Part Number	Page(s)
F4TZ9C968C.....	AP63401.....	8	F81Z9E527BRM.....	AP63801AB.....	4
F4TZ9C968CB.....	AP63401.....	8	F81Z9E527CRM.....	AP63803AD.....	4
F4TZ9D930K.....	AP63414.....	10	F81Z9E527DRM.....	AP63800AA.....	4
F4TZ9F538A.....	AP63411.....	6	F81Z9E527EARM.....	AP63804AE.....	4
F4TZ9VE527AARM.....	AP63800AA.....	4	F81Z9J294AA.....	AP63410.....	5
F5AZ12A648AB.....	AP63436.....	7	F8TZ9229AA.....	AP0001.....	10
F5TU11000AA.....	AP83000.....	12	F8UZ6B209CA.....	AP63421.....	11
F5TU11000AB.....	AP83000.....	12	FD3375.....	PFF829B.....	12
F5TU11000AD.....	AP83000.....	12	FD4495.....	PFF4595.....	12
F5TZ9151A.....	AP0008.....	10	FD4596.....	PFF4596.....	13
F5TZ9J294A.....	AP63409.....	5	FD4604.....	PFF4616.....	27
F61Z9VE527BRM.....	AP63801AB.....	4	FD4606.....	PFF4606.....	26
F61Z9VE527ERM.....	AP63804AE.....	4	FD4609.....	PFF4617.....	33
F6TZ2A451AA.....	AP63700.....	12	FG1054.....	AP63424.....	13
F6TZ8501AARM.....	AP63501.....	6	FG1057.....	AP63425.....	13
F6TZ9155AB.....	AP63424.....	13	FL2016.....	PFL2016.....	27, 34
F6TZ9157BA.....	AP0008.....	10	PFB93.....	AP63426.....	26
F6TZ9350A.....	APM61067.....	5	PFB95.....	AP63450.....	33
F6TZ9A543ARM.....	HP005X.....	6	PFB98.....	AP63431.....	26
F6TZ9C977AN.....	AP0003.....	10	PFB101.....	AP63426.....	26
F6TZ9F838A.....	AP63418.....	8	PFF5550.....	PFF4617.....	33
F7TZ12B533A.....	AP63405.....	8	PT121.....	AP0022.....	79
F7TZ12B533CA.....	AP63405.....	8	PW480.....	AP63502.....	16
F7TZ12B599AC.....	AP65110.....	5	PW482.....	AP63504.....	28
F7TZ12K073A.....	AP63400.....	7	PW491.....	AP63503.....	16
F7TZ12K073B.....	AP63400.....	7	SA965.....	AP83007.....	33
F7TZ6A636AAA.....	AP0004.....	10	SW5267.....	AP63435.....	7, 18, 30
F7TZ9E527ARM.....	AP63800AA.....	4	SW6052.....	AP63437.....	18, 30
F7TZ9E527BRM.....	AP63801AB.....	4	TP1298B.....	PFF50216.....	85
F81Z12B533AC.....	AP63405.....	8	W301386.....	AP0028.....	23
F81Z2A451BA.....	AP63433.....	12, 25	W301390.....	AP0028.....	23
F81Z6584AA.....	AP0014.....	11	W302209.....	AP0028.....	23
F81Z6N653BA.....	AP63461.....	11	XC3Z12B599AA.....	AP65120.....	5
F81Z8501ARM.....	AP63501.....	6	XC3Z9E527AARM.....	AP63804AE.....	4
F81Z8501CRM.....	AP63501.....	6	YB632.....	AP63430.....	25
F81Z9155AC.....	AP63425.....	13	YC3Z12B533AA.....	AP63406.....	4, 14, 28
F81Z9278AA.....	AP63435.....	7, 18, 30	YC3Z9350CA.....	APM61067.....	5
F81Z9A543BRM.....	HP007X.....	7			
F81Z9A543CRM.....	HP008X.....	7			
F81Z9C065AA.....	AP0007.....	11			
F81Z9C407AC.....	69136.....	5			
F81Z9C968AA.....	AP63402.....	8			
F81Z9C968AB.....	AP63402.....	8			
F81Z9D930AB.....	AP63413.....	10			

INDEX

ALLIANT POWER PART NUMBER INDEX

AP Part Number	Page(s)	AP Part Number	Page(s)	AP Part Number	Page(s)
69136.....	5	AP0044.....	24	AP63406.....	4, 14, 28
0-23000-1588.....	74	AP0045.....	83	AP63407.....	19, 48
228000-2292.....	92	AP0046.....	83	AP63408.....	18, 48
428000-5940.....	92	AP0047.....	84	AP63409.....	5, 39
AP0001.....	10, 43, 64, 67	AP0048.....	84	AP63410.....	5, 39, 45
AP0002.....	22, 52	AP0049.....	84	AP63411.....	6, 39
AP0003.....	10, 43, 64	AP0050.....	84	AP63412.....	18, 29, 47, 56, 72
AP0004.....	10, 43	AP0051.....	84	AP63413.....	10, 43
AP0005.....	23, 52	AP0052.....	84	AP63414.....	10, 43
AP0006.....	65, 74	AP0053.....	91	AP63415.....	18, 29, 47, 56, 72
AP0007.....	11	AP0054.....	92	AP63416.....	20, 50
AP0008.....	10	AP0055.....	92	AP63417.....	20, 50
AP0009.....	9, 42	AP0056.....	21, 31, 51, 58, 73	AP63418.....	8, 41
AP0010.....	9, 42	AP0057.....	53	AP63419.....	79
AP0011.....	11, 43	AP0058.....	91	AP63420.....	79
AP0012.....	91	AP0059.....	81	AP63421.....	11
AP0013.....	11, 44	AP0064.....	32	AP63422.....	29, 56
AP0014.....	11, 44	AP0067.....	80	AP63423.....	29, 48, 56, 72
AP0015.....	9, 42	AP0068.....	9, 22, 35, 42, 52, 64, 74, 82	AP63424.....	13
AP0016.....	9, 42	AP0069.....	100	AP63425.....	13
AP0017.....	100	AP0070.....	24, 53	AP63426.....	26
AP0018.....	21, 51, 73	AP0071.....	33	AP63427.....	90
AP0019.....	21, 51, 73	AP0072.....	59	AP63428.....	90
AP0020.....	21, 52, 74	AP0073.....	59	AP63429.....	8, 63
AP0021.....	9, 20, 31, 42, 51, 58, 64, 73	AP0076.....	32	AP63430.....	25
AP0022.....	79	AP3035342.....	88	AP63431.....	26
AP0023.....	23, 52	AP3035344.....	88	AP63432.....	25
AP0024.....	79	AP4024808.....	88	AP63433.....	12, 25
AP0025.....	74	AP4024809.....	88	AP63434.....	62
AP0026.....	74	AP4089602.....	89	AP63435.....	7, 18, 30, 48
AP0027.....	32, 58	AP4943048.....	89	AP63436.....	7
AP0028.....	23, 53	AP4988747.....	89	AP63437.....	18, 30, 48, 57, 72
AP0029.....	82	AP60900*.....	14, 45	AP63438*.....	20, 50
AP0030.....	21, 51	AP60901*.....	14, 45	AP63439*.....	20
AP0031.....	22	AP61000.....	96	AP63440.....	78
AP0032.....	22	AP61001.....	96	AP63441.....	78
AP0033.....	22	AP61002.....	97	AP63442.....	81
AP0034.....	80	AP61003.....	97	AP63443.....	79
AP0035.....	23, 53	AP61004.....	35	AP63444.....	79
AP0036.....	65	AP61005.....	97	AP63445.....	15, 45
AP0037.....	100	AP63400.....	7, 40	AP63446.....	15, 46
AP0038.....	65	AP63401.....	8, 41, 63	AP63447.....	25, 53
AP0039.....	23, 53	AP63402.....	8, 41, 63	AP63448.....	25
AP0040.....	21, 51	AP63403.....	8, 18, 41, 48	AP63449.....	85
AP0042.....	32, 58	AP63404.....	6	AP63450.....	33
AP0043.....	24	AP63405.....	8, 41	AP63451.....	16, 46

ALLIANT POWER PART NUMBER INDEX

AP Part Number	Page(s)
AP63452	6, 39, 62
AP63453	91
AP63454	16
AP63455	16
AP63456	31, 58
AP63457	82
AP63458	90
AP63459	50
AP63460	19, 49
AP63461	11, 44
AP63462	19, 49, 72
AP63463	19, 30, 49, 57
AP63464	64
AP63465	63
AP63466	63
AP63467	89
AP63470	30, 57
AP63471	30, 57, 72
AP63472	28
AP63473	30
AP63475*	31
AP63476	31, 49, 57, 73
AP63478	89
AP63479	50
AP63480	56
AP63501	6
AP63502	16
AP63503	16, 46
AP63504	28
AP63531	90
AP63532	90
AP63533	93
AP63560	78
AP63561	78
AP63562	82
AP63563	82
AP63580	62
AP63581	39
AP63582	70
AP63583	46
AP63600	96
AP63601	96
AP63640*	29
AP63641*	55
AP63642*	55
AP63660	Supersedes to AP63661

AP Part Number	Page(s)
AP63661*	17, 46
AP63662*	17, 47
AP63663*	17, 47
AP63680*	70
AP63681*	70
AP63682*	70
AP63683*	70
AP63684*	71
AP63685*	71
AP63686*	71
AP63687*	71
AP63700	12
AP63701	80
AP63702	80
AP63703	25
AP63720	81
AP63721	81
AP63722	81
AP63723	81
AP63800AA*	4, 38
AP63801AB*	4, 38
AP63802AC*	38
AP63803AD*	4, 38
AP63804AE*	4, 38
AP63805BA*	60, 66
AP63806BB*	60
AP63807BC*	60
AP63808BD*	60, 66
AP63809BE*	60
AP63810BF*	60, 66
AP63811BI*	61, 66
AP63812BJ*	61, 66
AP63813BN*	61, 67
AP63814BP*	61, 67
AP64800	Supersedes to AP64900
AP64801	Supersedes to AP64901
AP64900*	28, 55
AP64901*	55
AP65110*	5
AP65120*	5
AP65122*	15
AP65123*	15
AP65124*	15
AP66818	Supersedes to AP66918
AP66821	Supersedes to AP66921
AP66855*	69

AP Part Number	Page(s)
AP66857*	69
AP66858*	69
AP66889	Supersedes to AP66989
AP66892	Supersedes to AP66992
AP66895	Supersedes to AP66995
AP66918*	69
AP66921*	69
AP66976*	68
AP66977*	68
AP66978*	68
AP66979*	68
AP66989*	68
AP66992*	68
AP66995*	69
AP83000	12
AP83006	26
AP83007	33
APE65110	80
APM61067	5, 39
BG	61
HP004X	6, 40
HP005X	6, 40
HP007X	7, 40
HP008X	7, 40
HP020X	62
HP021X	62
HP022X	62
HP032X	17, 47
PFF31795	26, 54
PFF4595	12, 44
PFF4596	13, 54
PFF4606	26
PFF4616	27, 54
PFF4617	33
PFF50216	85
PFF58567	85
PFF829B	12
PFL2016	27, 34, 54, 59
PFRK20567	12
RK31019	13, 44
RK31449	13, 54
RK31821	27, 34, 54, 59
RK32138	27
RK42043	85
S14-101DAM	85

* Indicates products with a core charge.

***For Additional Information
such as OEM Cross Reference
and Product Instructions
Please Visit alliantpower.com***

TRADEMARKS

AGCO® is a registered trademark of AGCO Corporation.

Bosch® is a registered trademark licensed by Robert Bosch GmbH, Germany.

Cummins®, ISB®, and B-Series® are registered trademarks of Cummins Engine Company, Inc.

Detroit Diesel® and Series 50/60® are registered trademarks of Detroit Diesel Corporation.

Dodge® and Ram® are registered trademarks of Chrysler Group, LLC.

DMAX® is a registered trademark of DMAX Ltd.

Ford®, Motorcraft®, and Power Stroke® are registered trademarks of Ford Motor Company.

Freightliner® is a registered trademark of Daimler AG.

F Series®, F-250®, F-350®, F-450®, F-550®, F-650®, F-750®, E Series®, Econoline®, and Excursion® are registered trademarks of Ford Motor Company.

GM®, GMC®, Chevrolet®, Chevy®, Duramax®, Express®, Savana®, Sierra®, and Silverado® are registered trademarks of General Motors, LLC.

HEUI® is a registered trademark of Caterpillar, Inc.

IH® is a registered trademark of CNH America, LLC.

International® and MaxxForce® are registered trademarks of International Truck Intellectual Property Company, LLC.

Jeep®, Jeep Liberty®, and Jeep Grand Cherokee® are registered trademarks of Chrysler Group, LLC.

Mack® and Mack Trucks® are registered trademarks of Volvo AB.

M-B®, OM®, and Mercedes-Benz® are registered trademarks of Daimler AG.

Navistar® is a registered trademark of Navistar International Corporation.

Perkins® and 1300 Series EDi® are registered trademarks of Perkins Engines Company Limited, a subsidiary of Caterpillar, Inc.

Siemens® is a registered trademark of Siemens AG.

Sprinter® and/or Mercedes-Benz® Sprinter® are registered trademarks of Daimler AG.

Stanadyne® is a registered trademark of Stanadyne Corporation.

All other manufacturer names, models, part numbers, and product images used herein are for reference purposes only.



ALLIANT POWER

A DIESEL FORWARD COMPANY



6167 Pepsi Way, Windsor WI 53598 • 608.842.5180 • 866.283.1785 • fax: 608.842.5150 • alliantpower.com



©2015 Alliant Power – A Diesel Forward Company All Rights Reserved

APG0115