

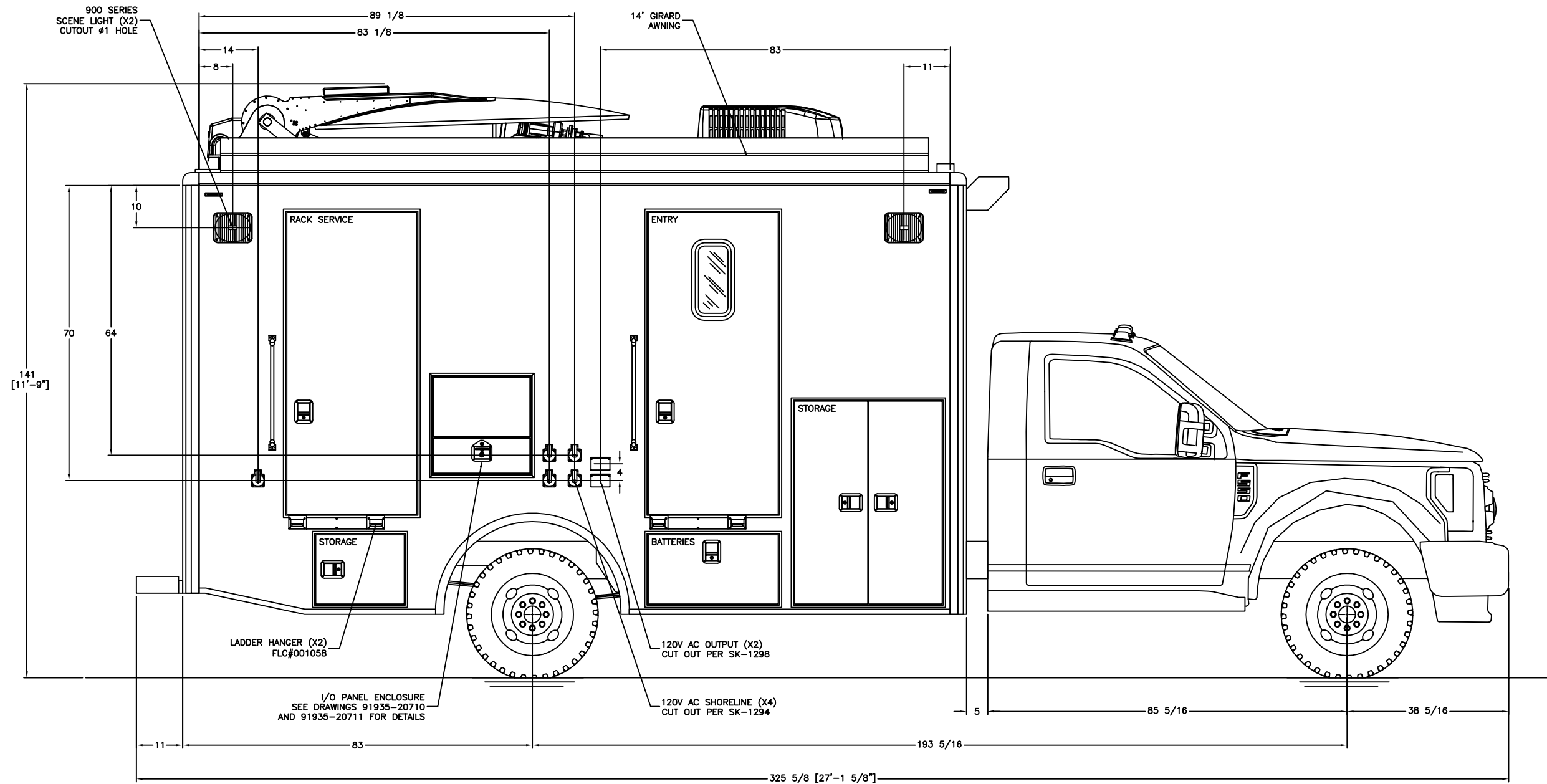

REVISIONS					
CHK DATE	CHK BY	DESCRIPTION	DATE	BY	REV
10/19/20	PJS	ADD CABLE PASS THRU	10/14/20	MRS	01



THIS DRAWING IS THE PROPERTY OF FRONTLINE COMMUNICATIONS CORPORATION. IT IS CONFIDENTIAL AND ALL RIGHTS ARE RESERVED. IT SHALL NOT BE REPRODUCED, COPIED, LENT, NOR USED FOR ANY PURPOSE OTHER THAN THAT FOR WHICH IT IS SPECIFICALLY FURNISHED.

DO NOT SCALE THIS DRAWING DIMENSIONS ARE IN INCHES UNLESS OTHERWISE SPECIFIED		MATERIAL <b>SEE NOTES</b>		 12770 44th Street North Clearwater, FL 33762-4713 (727) 573-0400 A Division of Pierce Manufacturing Inc. FAX (727) 571-3295	
TOLERANCES: ANGULAR: ± 1° BEND: ± 1° 2 PLACE DECIMAL ± .010 3 PLACE DECIMAL ± .005 FRACTIONS ± 1/16		FINISH <b>MILL FINISH</b>			
JOB NUMBER OR PRODUCT LINE <b>91935</b>		DRAWN BY <b>MRS</b>	DATE <b>10/31/19</b>	<b>EXTERIOR LAYOUT PASSENGER SIDE</b>  SIZE DWG NO. <b>B 91935-50200</b>	
SHEET <b>1 OF 1</b>	SCALE <b>30</b>	CHECKED BY <b>RPM</b>	DATE <b>10/31/19</b>		

REVISIONS							
CHK DATE	CHK BY	DESCRIPTION			DATE	BY	REV
XX/XX/XX	XXX	ENGINEERING RELEASE			9/24/19	MRS	00

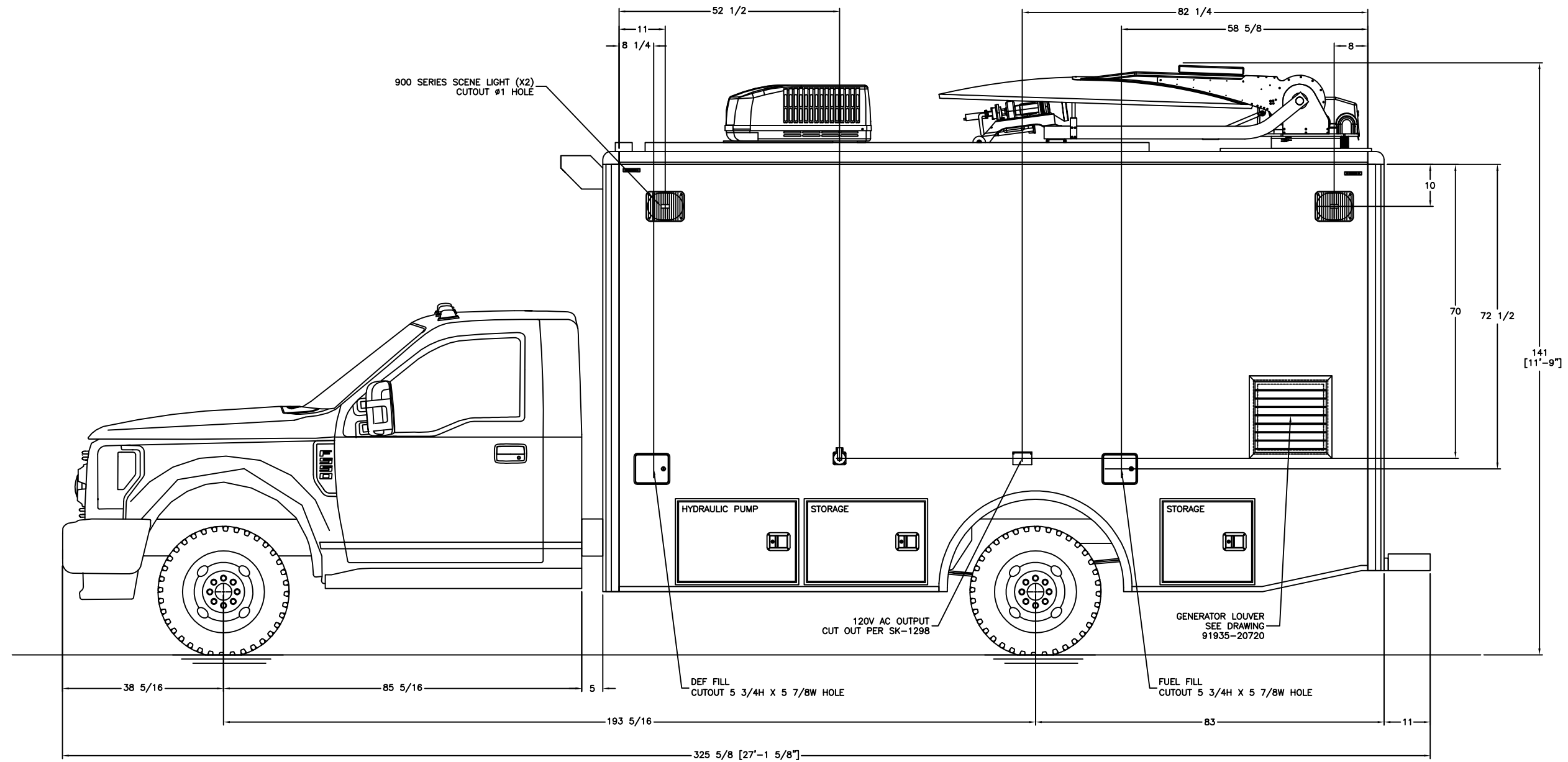

THIS DRAWING IS THE PROPERTY OF FRONTLINE COMMUNICATIONS CORPORATION. IT IS CONFIDENTIAL AND ALL RIGHTS ARE RESERVED. IT SHALL NOT BE REPRODUCED, COPIED, LENT, NOR USED FOR ANY PURPOSE OTHER THAN THAT FOR WHICH IT IS SPECIFICALLY FURNISHED.

DO NOT SCALE THIS DRAWING DIMENSIONS ARE IN INCHES UNLESS OTHERWISE SPECIFIED		MATERIAL <b>SEE NOTES</b>		 12770 44th Street North Clearwater, FL 33762-4713 (727) 573-0400 FAX (727) 571-3295 A Division of Pierce Manufacturing Inc.	
TOLERANCES: ANGULAR: ± 1° BEND: ± 1° 2 PLACE DECIMAL ± .010 3 PLACE DECIMAL ± .005 FRACTIONS ± 1/16		FINISH <b>MILL FINISH</b>		<b>EXTERIOR LAYOUT DRIVER SIDE</b>	
JOB NUMBER OR PRODUCT LINE <b>91935</b>		DRAWN BY <b>MRS</b>	DATE <b>9/24/19</b>		
SHEET <b>1 OF 1</b>	SCALE <b>30</b>	CHECKED BY <b>XXX</b>	DATE <b>XX/XX/XX</b>	SIZE <b>B</b>	DWG NO. <b>91935-50300</b>

REVISIONS							
CHK DATE	CHK BY	DESCRIPTION			DATE	BY	REV
XX/XX/XX	XXX	ENGINEERING RELEASE			9/23/19	MRS	00

ANTENNA MOUNTING BOX  
AS PER SK-3715-36

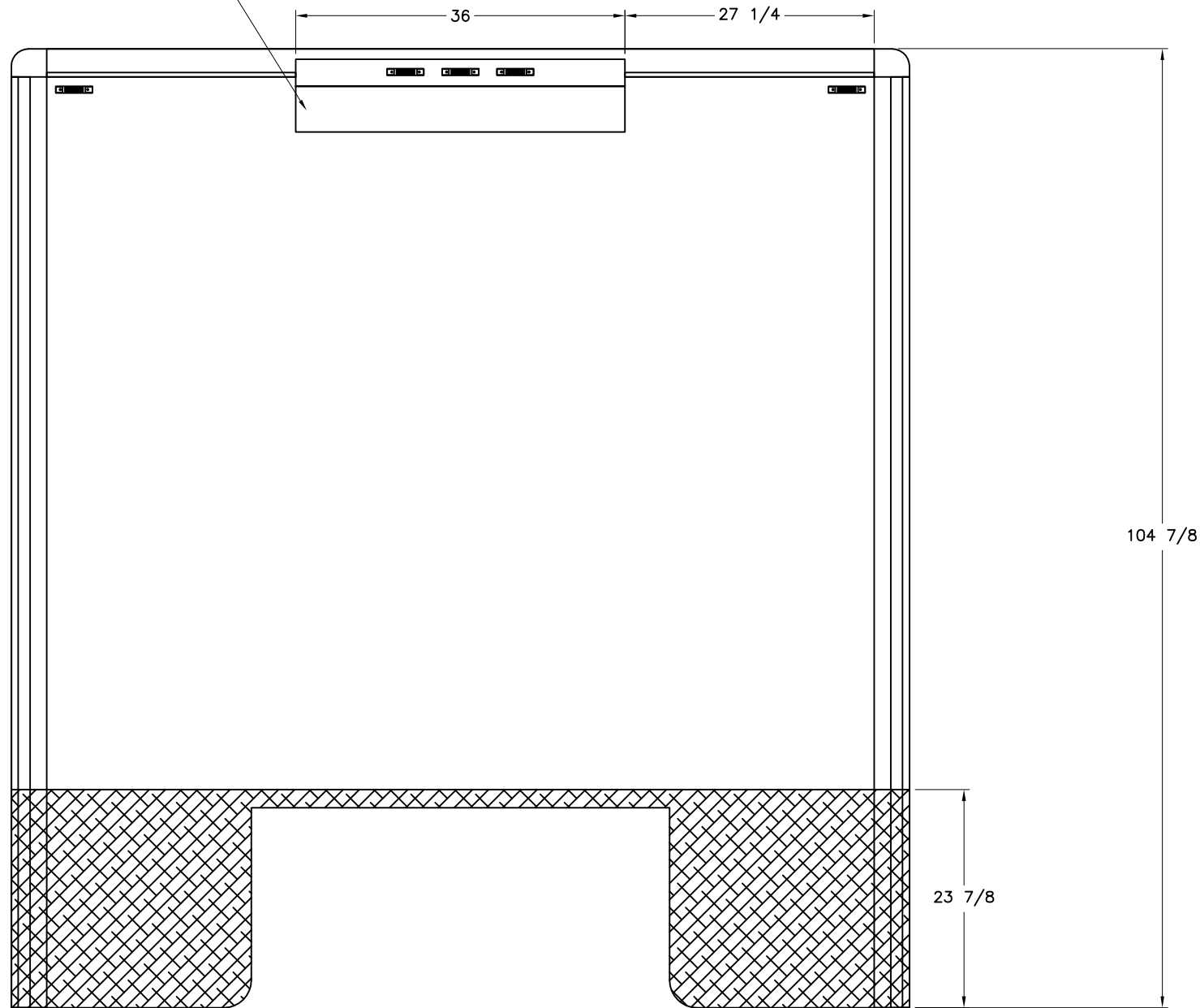

THIS DRAWING IS THE PROPERTY OF FRONTLINE COMMUNICATIONS CORPORATION. IT IS CONFIDENTIAL AND ALL RIGHTS ARE RESERVED. IT SHALL NOT BE REPRODUCED, COPIED, LENT, NOR USED FOR ANY PURPOSE OTHER THAN THAT FOR WHICH IT IS SPECIFICALLY FURNISHED.

DO NOT SCALE THIS DRAWING DIMENSIONS ARE IN INCHES UNLESS OTHERWISE SPECIFIED		MATERIAL <b>SEE NOTES</b>		 12770 44th Street North Clearwater, FL 33762-4713 (727) 573-0400 An Oshkosh Corporation Company FAX (727) 571-3295	
TOLERANCES: ANGULAR: ± 1° BEND: ± 1" 2 PLACE DECIMAL ± .010 3 PLACE DECIMAL ± .005 FRACTIONS ± 1/16		FINISH <b>MILL FINISH</b>		<b>EXTERIOR LAYOUT FRONT WALL</b>	
JOB NUMBER OR PRODUCT LINE <b>91935</b>		DRAWN BY <b>MRS</b>	DATE <b>9/23/19</b>	SIZE <b>B</b>	
SHEET <b>1 OF 1</b>	SCALE <b>18</b>	CHECKED BY <b>RPM</b>	DATE <b>9/27/19</b>	DWG NO. <b>91935-50400</b>	

REVISIONS

CHK DATE	CHK BY	DESCRIPTION	DATE	BY	REV
XX/XX/XX	XXX	ENGINEERING RELEASE	9/23/19	MRS	00

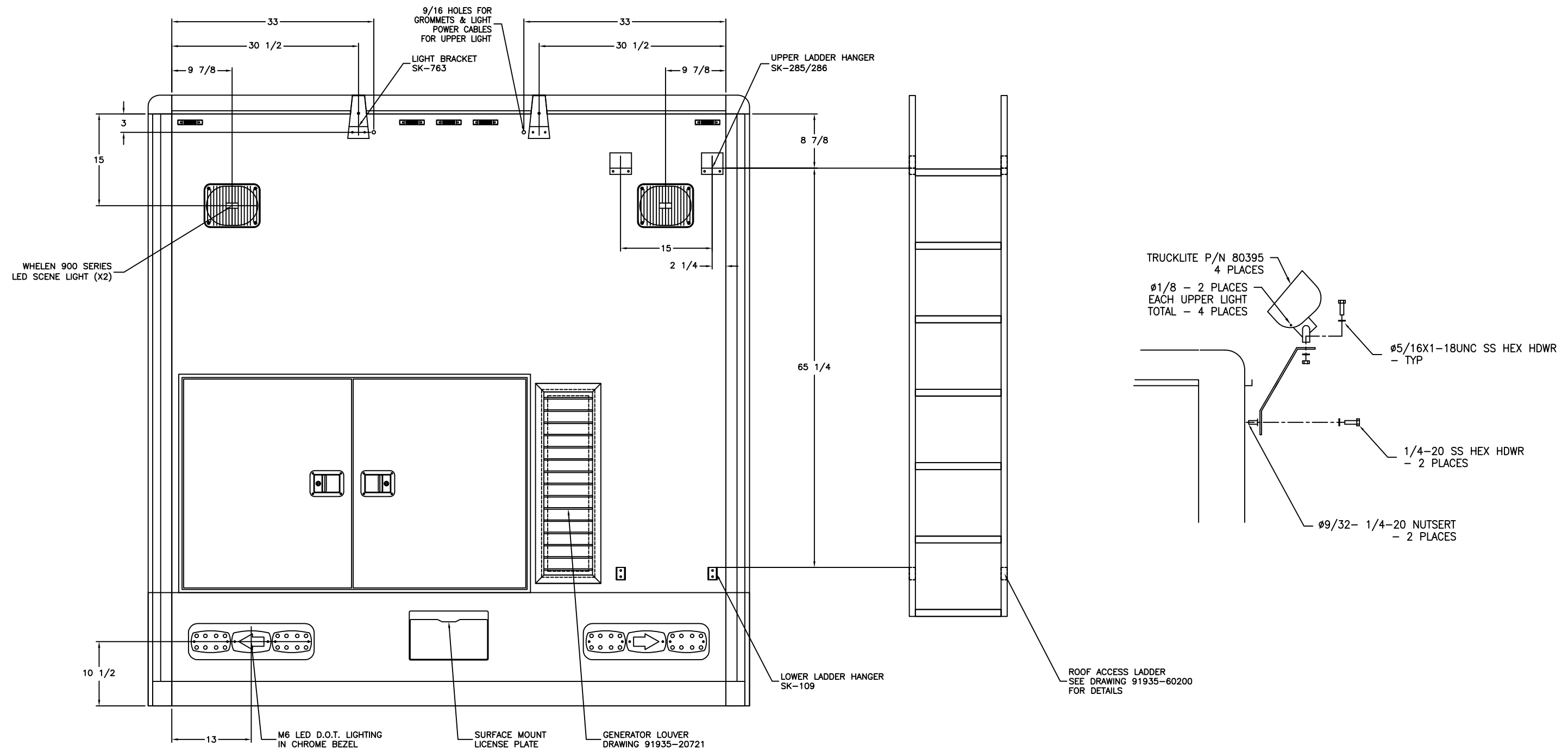

THIS DRAWING IS THE PROPERTY OF FRONTLINE COMMUNICATIONS CORPORATION. IT IS CONFIDENTIAL AND ALL RIGHTS ARE RESERVED. IT SHALL NOT BE REPRODUCED, COPIED, LENT, NOR USED FOR ANY PURPOSE OTHER THAN THAT FOR WHICH IT IS SPECIFICALLY FURNISHED.

DO NOT SCALE THIS DRAWING DIMENSIONS ARE IN INCHES UNLESS OTHERWISE SPECIFIED		MATERIAL <b>SEE NOTES</b>		 <p>12770 44th Street North Clearwater, FL 33762-4713 (727) 573-0400 FAX (727) 571-3295</p>	
TOLERANCES: ANGULAR: ± 1° BEND: ± 1° 2 PLACE DECIMAL ± .010 3 PLACE DECIMAL ± .005 FRACTIONS ± 1/16		FINISH <b>MILL FINISH</b>		<p><b>EXTERIOR LAYOUT REAR WALL</b></p>	
JOB NUMBER OR PRODUCT LINE <b>91935</b>		DRAWN BY <b>MRS</b>	DATE <b>9/23/19</b>		
SHEET <b>1 OF 1</b>	SCALE <b>18</b>	CHECKED BY <b>RPM</b>	DATE <b>9/27/19</b>	SIZE <b>B</b>	DWG NO. <b>91935-50500</b>

REVISIONS						
CHK DATE	CHK BY	DESCRIPTION		DATE	BY	REV
XX/XX/XX	XXX	ENGINEERING RELEASE		12/12/19	MRS	00

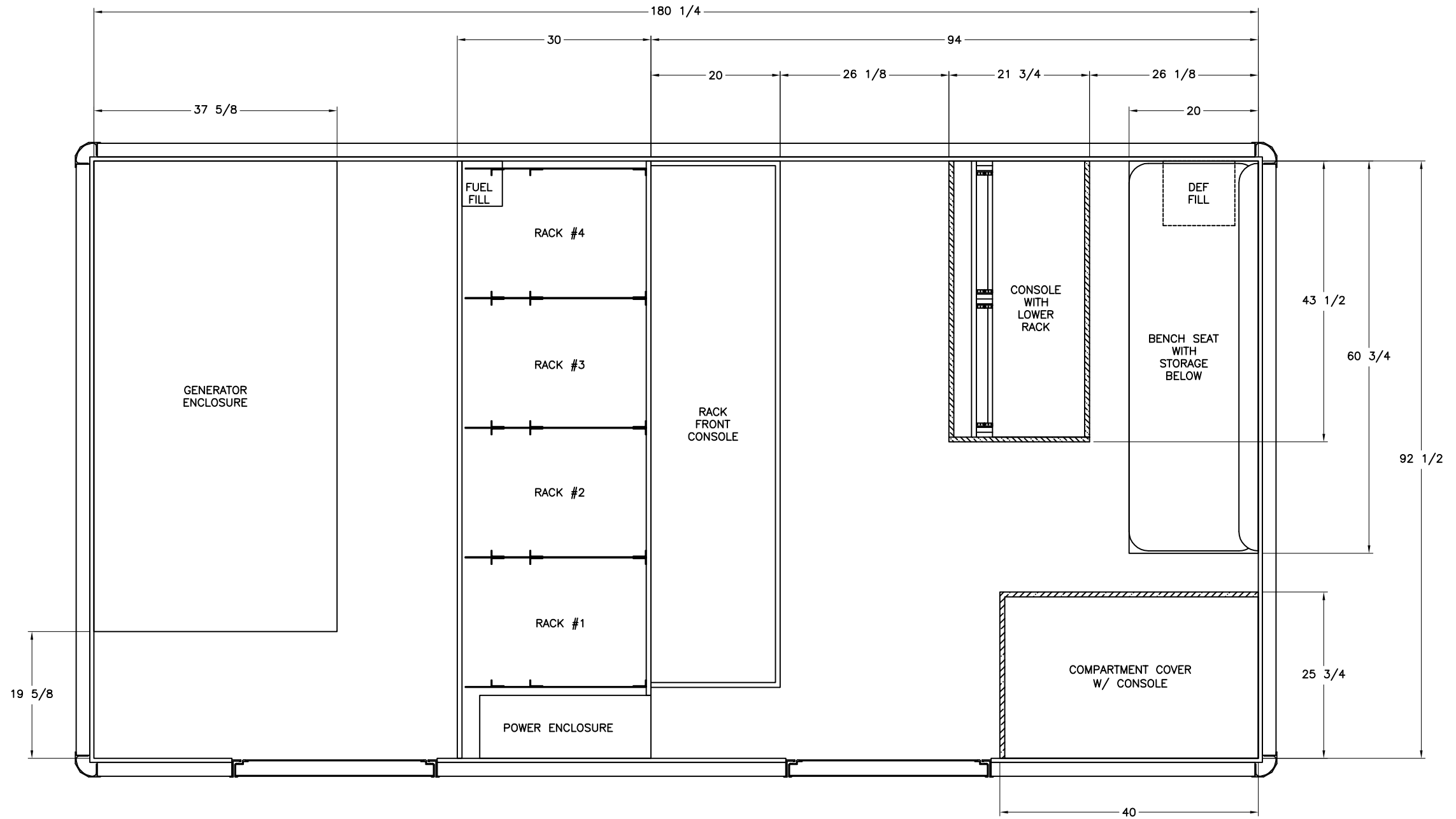

THIS DRAWING IS THE PROPERTY OF FRONTLINE COMMUNICATIONS CORPORATION. IT IS CONFIDENTIAL AND ALL RIGHTS ARE RESERVED. IT SHALL NOT BE REPRODUCED, COPIED, LENT, NOR USED FOR ANY PURPOSE OTHER THAN THAT FOR WHICH IT IS SPECIFICALLY FURNISHED.

DO NOT SCALE THIS DRAWING		MATERIAL		 12770 44th Street North Clearwater, FL 33762-4713 (727) 573-0400 FAX (727) 571-3295	
DIMENSIONS ARE IN INCHES UNLESS OTHERWISE SPECIFIED		SEE NOTES			
TOLERANCES:		FINISH		<b>INTERIOR LAYOUT FLOOR</b>	
ANGULAR: ± 1° BEND: ± 1"		MILL FINISH			
2 PLACE DECIMAL ± .010		DRAWN BY		DATE	
3 PLACE DECIMAL ± .005		MRS		12/12/19	
FRACTIONS ± 1/16		CHECKED BY		DATE	
JOB NUMBER OR PRODUCT LINE		RPM		12/20/19	
91935		SHEET		SIZE	
1 OF 1		SCALE		DWG NO.	
18		B		91935-40100	

REVISIONS					
CHK DATE	CHK BY	DESCRIPTION	DATE	BY	REV
1/20/20	RPM	ADDED AIR CONDITIONER PLATFORMS	1/20/20	MRS	01

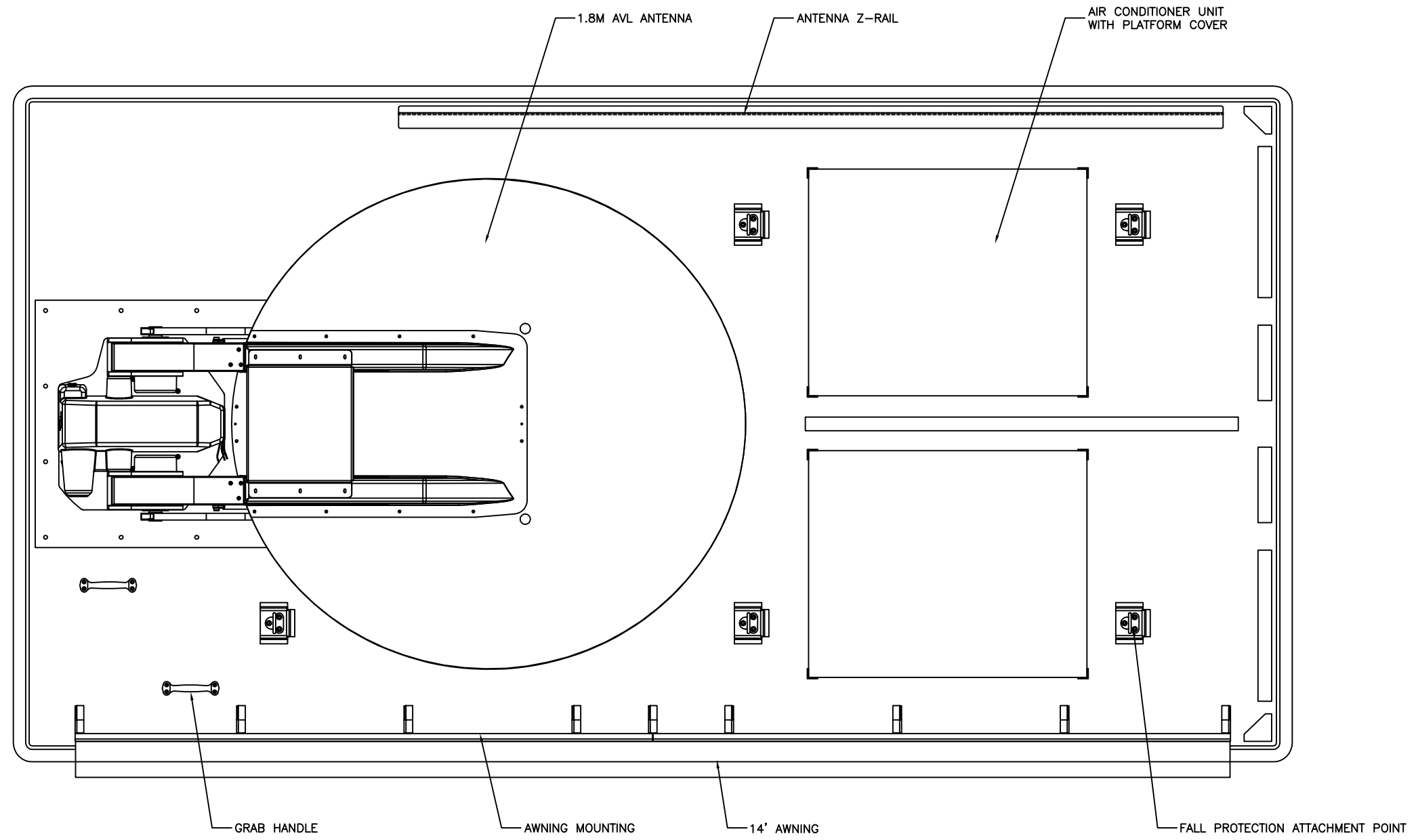

THIS DRAWING IS THE PROPERTY OF FRONTLINE COMMUNICATIONS CORPORATION. IT IS CONFIDENTIAL AND ALL RIGHTS ARE RESERVED. IT SHALL NOT BE REPRODUCED, COPIED, LENT, NOR USED FOR ANY PURPOSE OTHER THAN THAT FOR WHICH IT IS SPECIFICALLY FURNISHED.

DO NOT SCALE THIS DRAWING DIMENSIONS ARE IN INCHES UNLESS OTHERWISE SPECIFIED		MATERIAL <b>SEE NOTES</b>		 12770 44th Street North Clearwater, FL 33762-4713 (727) 573-0400 FAX (727) 571-3295	
TOLERANCES: ANGULAR: ± 1° BEND: ± 1° 2 PLACE DECIMAL ± .010 3 PLACE DECIMAL ± .005 FRACTIONS ± 1/16		FINISH <b>MILL FINISH</b>			
JOB NUMBER OR PRODUCT LINE <b>91935</b>		DRAWN BY <b>MRS</b>	DATE <b>9/27/19</b>	<b>EXTERIOR LAYOUT ROOF</b> SIZE DWG NO. <b>B 91935-50600</b>	
SHEET <b>1 OF 2</b>	SCALE <b>20</b>	CHECKED BY <b>RPM</b>	DATE <b>10/1/19</b>		