

# HT-400 & HT-600

Manual Clamshell with Pressure Readout  
15"x15" & 16"x20" Heat Transfer Machines

## OWNER'S MANUAL



HT-400



HT-600



**HIX CORPORATION**

For Customer Service, Call **1-800-835-0606**  
or Visit [www.hixcorp.com](http://www.hixcorp.com)

### CONTENTS

Receiving & Setup .....	2
Operation.....	3
Setting Temperature & Time .....	4
Preference Settings .....	5
Machine Presets .....	6-7
Cycle Count .....	8
Temperature & Time Modes .....	9
Platen Pressure .....	10
Transfer Application .....	11
Troubleshooting .....	12-14
Repairs .....	15
Maintenance .....	15
Warranty .....	16

**BEFORE warranty repair you MUST get Prior Authorization:**

# RECEIVING & SETUP

## SHIPPING OR RETURNS

**NOTE:** Save all of your shipping/packing materials.

**DO NOT RISK COSTLY SHIPPING DAMAGE!**

**SHIP ONLY IN ORIGINAL BOX.**

1. Fasten machine to plywood shipping base with bolts provided.
2. Tie or tape handle securely to base.
3. Place in original box, and put side liner and top liner in place. Fold in flaps and seal the box. (Additional bottom boards, box and liners may be obtained from your supplier for a nominal cost.)

## UNPACKING

Remember to save all packing materials - including box, liner and board. You may need these for shipping your machine or if a repair is necessary in the future.

## INSPECTION

Inspect your machine for hidden shipping damage. Contact the delivery company immediately, should you find damage.

## INSTALLATION

1. Remove plywood shipping base bolts (see **A** and **B**) and screw on feet or affix self-adhesive rubber feet provided.

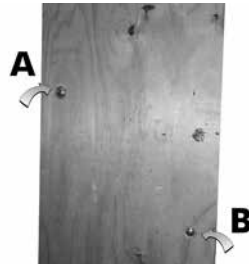

**CAUTION:** Handle **must be tied** to base before moving or shipping.

**ATTENTION:** Immobiliser la poignée avant de transporter.

2. Carefully cut tape/wrap holding machine closed.
3. Plug the machine into the correct grounded electrical outlet.

**WARNING:** When using an extension cord, use 12 or 14 ga.-3 conductor. Maximum length, 25' (7.762 m).

**ATTENTION:** Utiliser des ralonges d'au moins 12 à 14 ga - 3 phases; longueur maximale de 7.7 mètres.

# OPERATION

1. Turn on the machine by pushing the on/off switch.

Startup/Splash screen is displayed as the controller boots up.

**Note:** The current program number and the software revision of the controller are displayed at startup. (*The default settings are program number P 1 for °F, P 2 for °C and software revision RV 1.0*)



Startup/Splash Screen

After boot up, the home screen is displayed showing the current heat platen temperature and set cycle time. The heat indicating lamp is represented by the snowflake in the upper left corner of the display. The heat indicating lamp will display anytime the heating element is heating and will cycle on and off after the set temperature is reached to maintain set temperature.

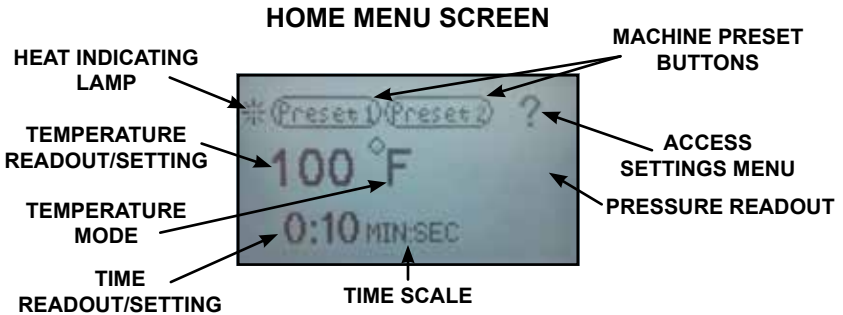

# SETTING TEMPERATURE & TIME

## ADJUST TEMPERATURE:

### TEMPERATURE ADJUSTMENT SCREEN



1. Touch the temperature readout on the display. “UP” ▲ and “DOWN” ▼ arrows will appear on the right side of the display and the temperature value will start flashing and to indicate it is in set mode.
2. Press the “UP” ▲ or “DOWN” ▼ arrow to change the temperature value. Holding down on an arrow will change the temperature in 1 degree increments for 10 values; then change to 10 degrees incremental changes.
3. Once the desired temperature value is set, either press the temperature value to lock the set temperature or simply wait for 2 seconds and it will lock in the new value automatically.

## ADJUST CYCLE TIME:

### TIME ADJUSTMENT SCREEN



1. Touch the time readout on the display. “UP” ▲ and “DOWN” ▼ arrows will appear on the right side of the display and the cycle time value will start flashing and to indicate it is in set mode.
2. Press the “UP” ▲ or “DOWN” ▼ arrow to change the cycle time value. Holding down on an arrow will change the time in 1 second increments for 5 values; then change to 10 seconds incremental changes.
3. Once the desired cycle time value is set, either press the time readout to lock the cycle time or simply wait for 2 seconds and it will lock in the new value automatically.

# PREFERENCE SETTINGS

## SETTINGS:

1. Press the “?” on the upper right corner of the display on the **Home Menu Screen** to access the settings menu.
2. Press the settings sub menu title to be adjusted.

## SETTINGS MENU SCREEN

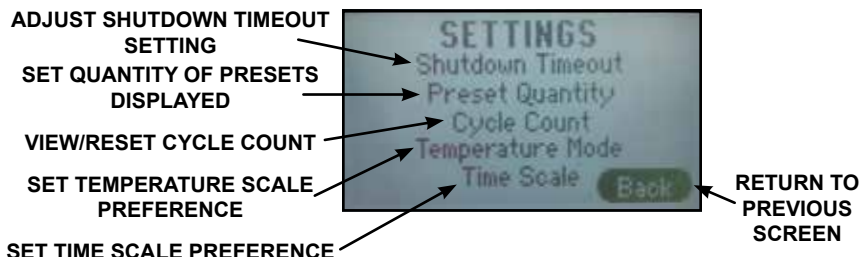

## SHUTDOWN TIMEOUT

The shutdown feature shuts off the heat to the press after a period of in-activity.

## SHUTDOWN TIMEOUT ADJUSTMENT SCREEN



**NOTE:** The factory default is set at 3.0 hours.

1. From the settings menu press the “**Shutdown Timeout**” sub menu title.
2. Press the “UP” ▲ and/or “DOWN” ▼ arrows to set the desired shutdown time.

**NOTE:** Shutdown time adjusts in 1/2 hour intervals. Press the “Down” ▼ button until “Disable” is displayed will deactivate this setting.

3. Press “**Save**” to save the setting.
4. Press “**Back**” to return to the previous screen.

**NOTE:** After the shutdown time has elapsed with the press idle, the heating element will stop cycling to maintain the set temperature and the home screen will display “**SHUTDOWN.**” Touching the display or closing the press will take the machine out of shutdown mode.

# MACHINE PRESETS

## PRESET QUANTITY

Temperature presets can be stored in the memory for different transfer settings. By default two presets are displayed. This setting can be adjusted to display four presets.

### PRESET QUANTITY DISPLAYED PREFERENCE SCREEN



1. From the settings menu press the **"Preset Quantity"** sub menu title.
2. Press the number of presets to be displayed on the home screen, either **"Two Presets"** or **"Four Presets."**

TWO PRESET DISPLAY  
ON HOME MENU SCREEN



FOUR PRESET DISPLAY  
ON HOME MENU SCREEN

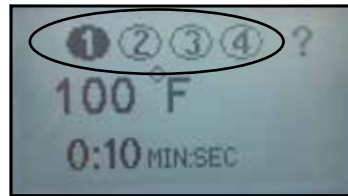

3. Press **"Save"** to save the setting.
4. Press **"Back"** to return to the previous screen.

**NOTE:** The "Toggle Two Presets" option will allow the operator to save two different times in each preset (e.g. 2 seconds in Preset 1 and 8 seconds in Preset 2). Each time the handle is closed and the timer times out then the controller will automatically "toggle" to the other preset. This will allow the operator to set a short "pre-press" time. The "No Presets" option, if selected, will remove the option for any preset buttons to appear on the Home Menu Screen.

# MACHINE PRESETS

## STORING PRESETS:

**NOTE:** The factory default settings for all presets is set to 200°F and 10 seconds.

### HOME MENU SCREEN

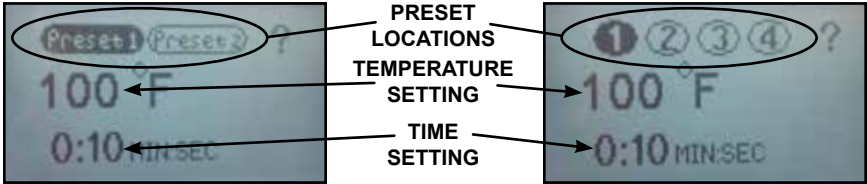

1. Set the desired temperature and/or cycle time using the temperature and time adjustment instructions in this document.
2. Press and hold the desired preset location for two seconds. The controller will beep and the preset location button will display in reverse indicating the preset is stored in memory.

**NOTE:** Always refer to specific transfer recommendations for temperature, time and pressure as instructed by the transfer manufacturer.

## RECALLING PRESETS:

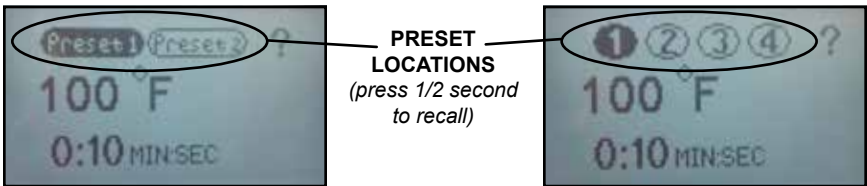

**PRESET 1 SELECTED**  
(two preset setting shown)

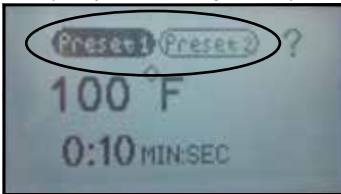

**PRESET 2 SELECTED**  
(two preset setting shown)

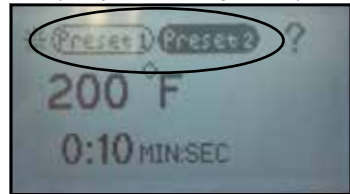

1. Press and release for approximately 1/2 second the preset button to recall. The controller will beep and the preset location button will display in reverse indicating the preset has been changed.

**NOTE:** The new set values will display for 1 second before the controller starts adjusting the temperature or time to match the new set-point.

# CYCLE COUNT

## CYCLE COUNT

The cycle count feature counts the number of cycles that the machine has undergone. A cycle is counted every time the countdown timer is activated by closing the press.

**NOTE:** The cycle count will maintain the total count even if the power has been turned off.

## CYCLE COUNT/CYCLE COUNT RESET SCREEN

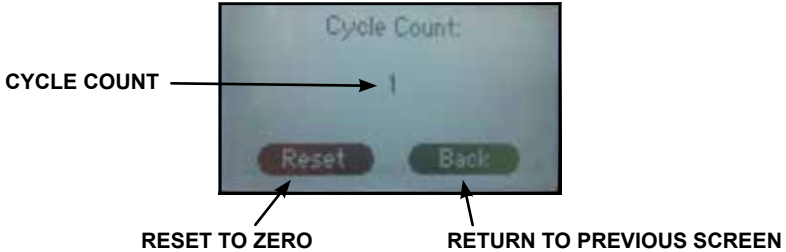

### TO RESET THE COUNTER:

1. From the settings menu press the "**Cycle Count**" sub menu title.
2. Press "**Reset.**"
3. Press "**Back**" to return to the previous screen.



# TEMPERATURE & TIME MODES

## TEMPERATURE MODE

Temperature Mode controls which temperature scale is displayed on the controller home screen.

**F** = Fahrenheit      **C** = Celsius

### TEMPERATURE MODE PREFERENCE SCREEN

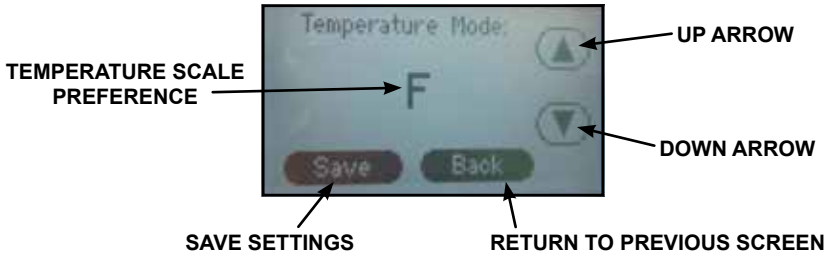

### TO CHANGE THE SCALE:

1. From the settings menu press the "**Temperature Mode**" sub menu title.
2. Press the "UP" ▲ or "DOWN" ▼ arrows to select the preferred temperature scale.
3. Press "**Save**" to save the setting.
4. Press "**Back**" to return to the previous screen.

## TIME SCALE

The time scale setting adjusts how the time is displayed on the home screen. There are three Time Scale display options available in the Time Scale menu:

- **MIN:SEC** (Factory Default)
- **SEC** (Seconds)
- **1/10 SEC** (1/10 Second Resolution)

### TO CHANGE THE SCALE:

#### TIME MODE PREFERENCE SCREEN



1. From the settings menu press the "**Time Scale**" sub menu title.
2. Press the "UP" ▲ and/or "DOWN" ▼ arrows to select the preferred time scale.
3. Press "**Save**" to save the setting.
4. Press "**Back**" to return to the previous screen.

# PLATEN PRESSURE

The pressure control knob, located on the top of the machine, should be set so that the heat head will lock down firmly.

Pressure is reduced by turning knob (with machine open) **counter-clockwise** and increased by turning it **clockwise**.

**Pressure knob**



## PLATEN PRESSURE READOUT

The amount of platen pressure being exerted on the transfer and substrate can be monitored on the controller. When the machine is closed, the platen pressure is expressed in a numerical value between 0-9 on the controller home screen. Values of 0-3 indicate “light” pressure, 4-6 “medium” pressure and 7-9 “heavy” pressure. If the value exceeds 9 then “Pressure High” will appear on the display indicating that the maximum value that can be displayed has been exceeded.

### HOME MENU SCREEN



**PLATEN PRESSURE INDICATOR ICON**

**PLATEN PRESSURE READOUT VALUE**

**NOTE:** Adjustments may be required from one garment to another and will vary to achieve the desired result.

**WARNING:** Excessive pressure can cause structural damage, voiding the machine warranty!

**ATTENTION:** Pression excessive peut endommager la machine et annuler la garanti.

## TRANSFER APPLICATION

The 120 volt models have a slower heat recovery (i.e. 18-20 seconds @ 375°F). The 220 volt models are recommended for quicker cycle times (i.e. 10 seconds @ 375°F).

1. Set the temperature, time, & pressure to the desired settings as instructed. **Always** consult your specific transfer recommendations. Typical settings are; **Cold Peel:** 350°F (177°C), 15 seconds and **Hot Split:** 375°F (190°C), 10-12 seconds.

2. Align substrate on lower platen. Smooth wrinkle from garments.

**NOTE:** Wrinkles may be removed by bringing the heated platen in contact with the garment for a few seconds before the transfer is positioned.

3. Position the transfer in the desired location on the substrate.

**NOTE:** The transfer image should be “mirrored” before transferring except when transferring to substrates where the image shows through, i.e. glass tiles and cutting boards.

***TIP:** When transferring double sided or sublimation transfers to garments, always place a sheet of transfer paper or a PTFE sheet between the layers of the garments to avoid bleed through or reheating of the applied transfer.*

4. Pull the handle down until the handle locks.

**NOTE:** Do not fold the transfer back on itself. Successful transfer work depends on the correct balance of time, temperature and pressure. The type and thickness of the material and the kind of transfer being used will determine what settings are necessary.

For hot peel/split transfers, immediately peel the paper after the machine has opened. **DO NOT** allow the transfer to cool. For cold peel transfers, rub the transfer with an eraser or cloth and allow to cool for 5-10 seconds before removing the release paper.

# TROUBLESHOOTING

**NOTE:** Specific application instructions are enclosed with transfers.

**When you fail to make a successful transfer you can wonder, “Is it the machine’s fault, or the transfer, wrong settings or what”?**

## **FIRST, THE BASICS:**

1. Be sure to set the heat transfer machine to the transfer manufacturer’s recommended Temperature, Time and Pressure settings. If you don’t have these specifications, contact your transfer supplier for this information and any other special application instructions as many of the new “High Tech” transfers require significantly different settings and/or application techniques than those from years past.
2. When you start up your press for the first time each day, preheat the pad for a minute. If the press has sat for 3-5 minutes without use, be sure to “preheat” the pad for 10-15 seconds before loading the shirt or making the first transfer.
3. After the shirt is positioned and centered on the preheated pad, “pre-press” the shirt for 3 seconds to take the wrinkles out and more importantly, release any excess moisture out of the T-shirt fabric which can reduce the chance of a successful transfer.
4. With all of the above recommendations, try making a transfer.
5. If successful, great! You are on your way to making some serious money with your transfer machine!
6. If you have an area that isn’t transferring completely or as you would like it to, follow these steps to determine the problem.
  - Try increasing the pressure on the machine by 10-20%
  - Recheck your temperature required and the press readout. You may want to increase the temperature 10 degrees.
  - Try increasing the application time by 2-4 seconds
  - If after trying these things there is still a “specific” area (say over in one corner of the transfer) that isn’t coming out as you would like it to, then try the same type transfer on a scrap shirt but rotate the transfer 180 degrees (changing the failure location) If after doing this the problem area is in the same physical location on the machine, then you probably have a problem with the pad or possibly a warped platen if the machine has ever overheated severely. On the other hand if the transfer failed in the same area on the transfer (after changing the location of where the problem had previously been occurring), then you most likely have a problem with the transfer or it’s application settings (Temperature, Time or Pressure) and you should contact your transfer supplier to discuss the problem.

Following these basic guidelines can help you be more successful with each and every transfer!

# TROUBLESHOOTING

\*Customer Service Tech Sheets are available for this step. Visit [www.hixcorp.com](http://www.hixcorp.com) to print or call 620-231-8568 and we will send you one. Parts ordering is available on-line.

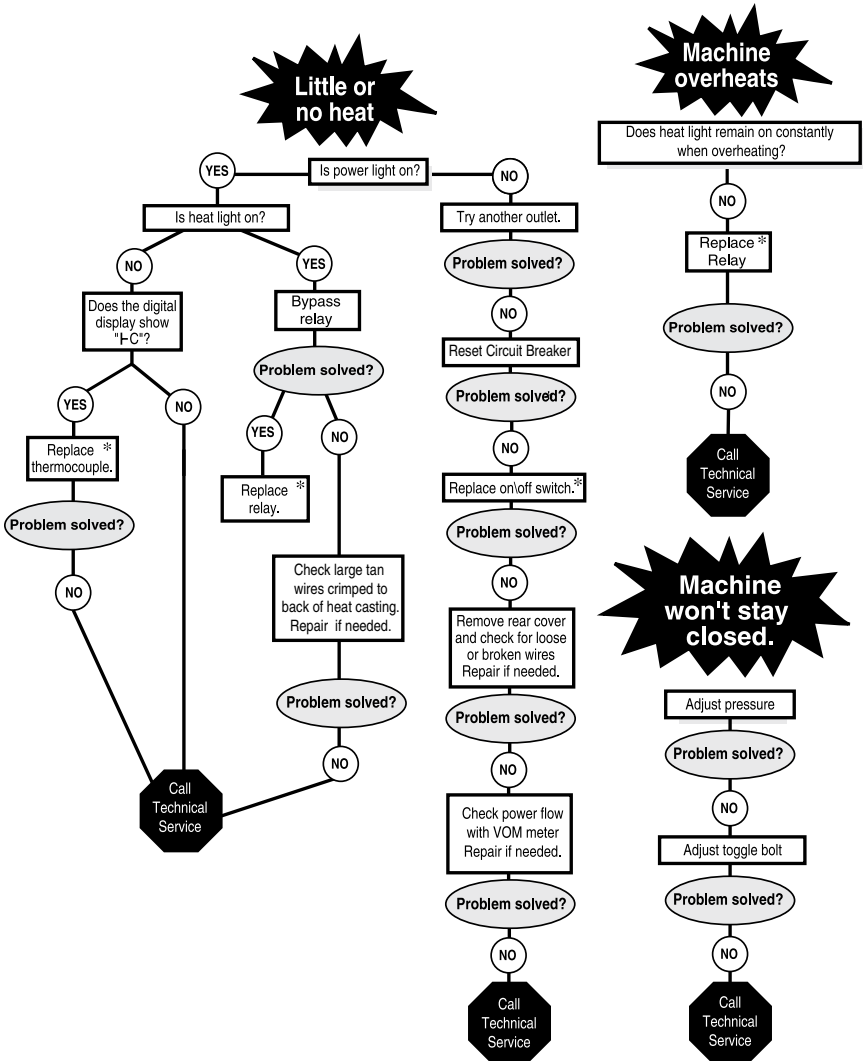

# TROUBLESHOOTING

**Problem:** Machine won't release at the end of time.

**Q. Do you hear the solenoid click when the timer reaches zero?**

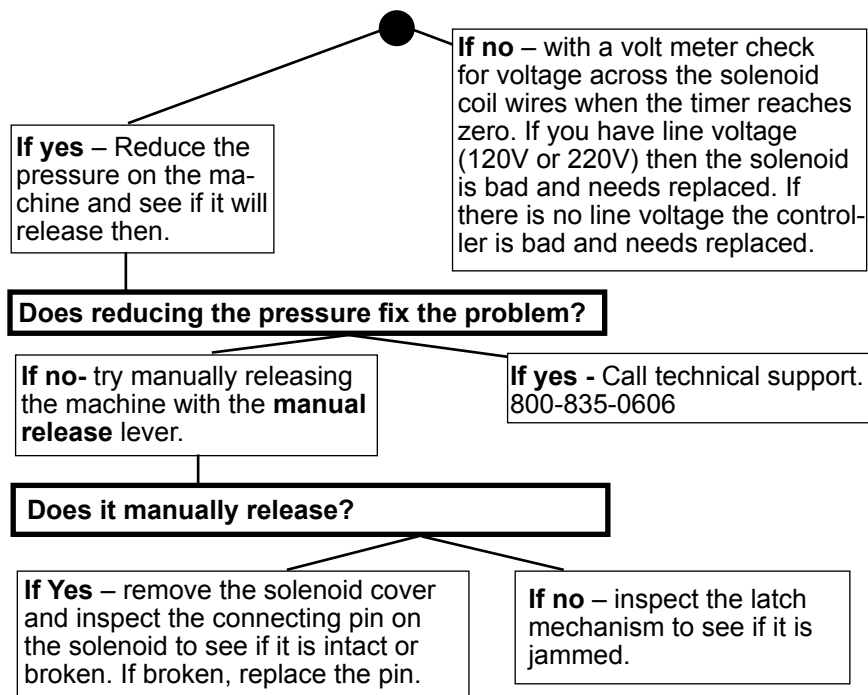

**Problem:** Platen pressure indicator not working properly.

**Q. Does the platen pressure display show “0” when the press is locked down?**

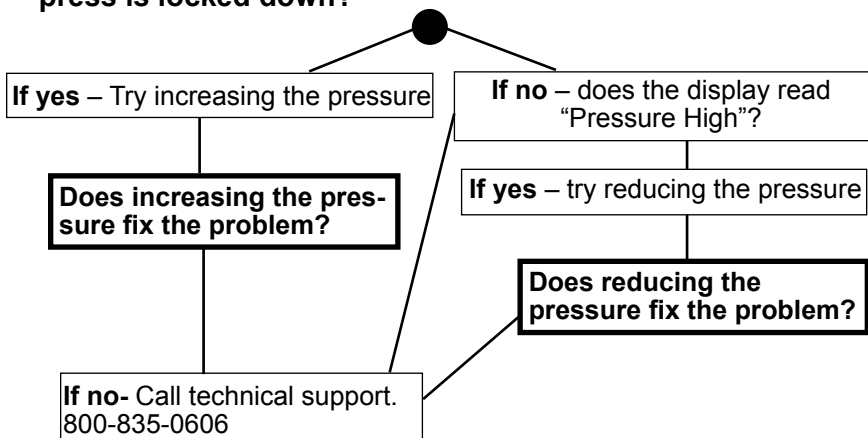

# REPAIRS

## RELAY BYPASS

**WARNING:** Before making repairs, be sure ON/OFF switch is OFF and machine is unplugged!

**ATTENTION:** Eteindre la machine avant de faire des réparations.

1. Remove the back cover of the machine.

**WARNING:** To prevent possible electrical shock, unplug the machine before removing cover to service.

**ATTENTION:** Afin d'éviter des chocs électriques, éteindre la machine avant d'ouvrir.

2. Remove wire #26 from terminal #2 on relay.

3. Loosen terminal #1 on relay and replace wire #26 along with wire #12 under terminal #1.

4. Tighten the connection.

5. Plug machine in and turn the power switch on.

**NOTE:** Replace the relay if the machine starts heating. This is a test only. Do not operate machine with relay bypassed.

# MAINTENANCE

## LUBRICATION

Your press requires lubrication every 15,000 cycles or every 6 months. Lubricate weekly in a heavy use production environment. Use NSF/NLG12 rated food grade grease (such as Bel-Ray No-Tox #2 or equivalent). A general purpose food grade machine oil spray is also acceptable such as CRC03055 lubricant (available from retailers such as Amazon). Lubricate all moving or hinged points.

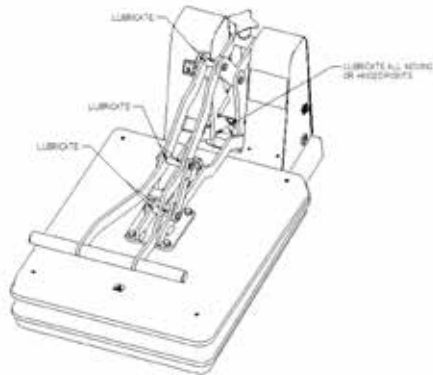

## CLEANING HEAT PLATEN

Clean the heat platen with steel wool, scrubbing aluminum sponge, or fine wire brush.

# WARRANTY

**(Effective 3/1/2020)**

HIX will automatically register the equipment on the date it was shipped to you or your distributor. If the equipment was not purchased directly from HIX, but through a distributor (either domestic or foreign), please keep a copy of their sales invoice showing the serial number and date it was sold/shipped to you with this warranty. In this case, we will use the distributor's invoice date as the beginning warranty date. **STAPLE A COPY OF YOUR PROOF OF PURCHASE TO THIS WARRANTY** and keep in a safe place to provide verification of your warranty should a problem occur. Thank you.

Please fill in the following information and attach a copy of your receipt for your records.

Date Purchased: \_\_\_\_\_ From: \_\_\_\_\_

Model #: \_\_\_\_\_ Serial #: \_\_\_\_\_

This warranty applies to equipment manufactured by the HIX Corporation (HIX), Pittsburg, Kansas, U.S.A. HIX warrants to the original purchaser, its Ovens and Dryers, Heat Transfer Machines, Textile Printers, Spot Heaters, and Exposure Units against defects in workmanship and material, except for wear and tear for a period of "One Year" from the date of purchase. HIX warrants Accessories for a period of 90 days from the date of purchase. doughXpress products are covered under separate warranty.

In the event of a defect, HIX, at its option, will repair, replace or substitute the defective item at no cost during this warranty period subject to the limitations of insurance and shipping costs stated below (excludes labor).

In the case of heat transfer presses (except the Hobby Lite and Large Format presses), HIX warrants the heat casting for the "Life" of the machine for the original purchaser. If a part becomes obsolete at the time for repair, and/or cannot be reasonably substituted for, HIX will credit, at half the then current list price or last recorded price, only that part toward a new machine or any product HIX offers. This credit offer shall be the sole responsibility of the HIX Corporation in the event of an obsolete part.

This warranty does not cover belts, rail tape, pads, mug wraps, canvas, rubber blankets, bulbs, glass. Warranty does not cover damages due to accident, misuse/abuse, alterations or damage due to neglect, shipping or lack of proper lubrication or maintenance. HIX shall not be responsible for repairs or alterations made by any person without the prior written authorization by HIX. This warranty is the sole and exclusive warranty of HIX and no person, agent, distributor, or dealer of HIX is authorized to change, amend or modify the terms set forth herein, in whole or in part.

In the case of a problem with the equipment identified herein, HIX Corporation should be contacted during regular business hours to discuss the problem and verify an existing warranty. HIX personnel will assist the customer to correct any problems which can be corrected through operation or maintenance instructions, simple mechanical adjustments, or replacement of parts. In the event the problem cannot be corrected by phone, and upon the issuance of a return authorization by HIX, the equipment shall be returned to HIX or an authorized service representative. All insurance, packaging and shipment/freight costs are solely the responsibility of the customer, and not that of HIX, and HIX shall not be responsible for improper packaging, handling or damage in transit. Contact HIX customer service for complete return authorization information. Correct shipping boxes are available from HIX.

This expressed warranty is given in lieu of any and all other warranties, whether expressed or implied, including but not limited to those of merchantability and fitness for a particular purpose, and constitutes the only warranty made by HIX Corporation.

In no event shall HIX's liability for breach of warranty extend beyond the obligation to repair or replace the nonconforming goods. HIX shall not be liable for any other damages, either incidental or consequential, or the action as brought in contract, negligence or otherwise.

This warranty gives you specific legal rights and you may also have other rights which vary from state to state.



1201 E. 27th Terrace • Pittsburg, KS 66762 • U.S.A.  
Web site: [www.hixcorp.com](http://www.hixcorp.com) • Phone: (800) 835-0606 • Fax: 620-231-1598  
E-Mail: [customerservice@hixcorp.com](mailto:customerservice@hixcorp.com) • E-Mail: [sales@hixcorp.com](mailto:sales@hixcorp.com)