



OPERATOR'S GUIDE

TruRain Water Repellency Tester

Covering serial numbers
1930/19/1000 & upwards

Published by:

JAMES HEAL LTD.
RICHMOND WORKS
HALIFAX
WEST YORKSHIRE
HX3 6EP
ENGLAND

TELEPHONE +44 (0) 1422 366355
FACSIMILE +44 (0) 1422 352440

E-mail info@james-heal.co.uk
Internet <http://www.james-heal.co.uk>

© 2019

TABLE OF CONTENTS

TABLE OF CONTENTS	2
James Heal.....	4
Setting the Standard.....	4
Areas of Expertise	4
1. Introduction	5
1.1. TruRain – Water Repellency Tester.....	5
1.2. Features & Benefits	5
1.3. Service & Calibration.....	5
1.4. Technical Assistance.....	5
1.5. Standards.....	5
2. General Information.....	6
2.1.....	6
2.2. Revision History	6
2.3. EU & EC – Declaration of Conformity.....	7
2.4. General Description and Use of Equipment.....	8
2.4.1. Definition of Water Repellency	8
3. Safety and environmental protection summary	8
3.1. Safety Summary	8
3.2. Safety Precautions	10
3.3. Operator Safety	10
3.4. Customer Responsibilities.....	11
3.4.1. Cleaning & Maintenance	11
3.4.2. Water system safety	11
3.4.3. Recirculation settings	11
3.4.4. Filter Replacement and Cleaning	12
3.4.5. Correct PPE.....	15
3.5. Caution Labels.....	15
4. Instrument Specification.....	16
5. Pre-Installation.....	17
5.1. Preinstall Checklist	17
5.2. Customer Responsibilities.....	17
5.3. Delivery	18
5.4. General Planning	18
5.4.1. Water Safety Plan	18
5.5. Area Planning	19
5.6. Electrical	19
5.6.1. Electrical Specifications	19
5.6.2. Power Cord	19
5.7. Water Re-circulation Unit Pre-installation	20
6. Installation.....	21
6.1. Receiving Inspection	21
6.2. Unpacking	21
6.2.1. Unpacking Checklist	21
6.3. Moving the machine.....	22

6.4. Lifting points.....	22
.....	22
6.5. Installation Procedure.....	23
6.6. Connections Preparation	24
6.6.1. Electrical.....	24
6.6.2. Water.....	24
6.6.3. Water recirculation Installation.....	24
6.7. System Settings	25
6.7.1. Water Pressure Settings	25
6.7.2. Recirculation settings	25
6.7.3. Recirculation system cleaning & disinfection	25
6.7.4. Machine drain-down procedure.....	27
6.7.5. Draining the showerhead.....	32
6.8. Spares and Accessories	35
6.9. Product Overview.....	36
6.9.1. External instrument components	36
6.9.2. Plumbing components	37
6.9.3. Carousel components	39
7. Touchscreen Interface.....	40
8. Operation.....	42
8.1. Test preparation	42
8.1.1. Flow rate calibration procedure.....	44
8.2. Test Procedure	46
10. Fault Finding	48
11. Service & Calibration.....	49
11.1. Software.....	49

JAMES HEAL

At James Heal, we are dedicated to designing and developing high precision testing instruments and test materials for physical and colour fastness testing. Our worldwide Service and Calibration division and expert technical assistance complement our product range, adding real value to your laboratory testing activities.

Setting the Standard

We are committed to forming close relationships and have established numerous partnerships within the textile industry, from trade and standards organizations, to test houses, customers and distribution partners.

With a heritage spanning more than 140 years, we have evolved and grown through a culture of continuous improvement, resulting in a thorough understanding of the applications, operating conditions and requirements of customers worldwide – from independent testing laboratories and test houses, to fabric suppliers, manufacturers and retailers.

Using knowledge and expertise, we consistently set the industry standard through product innovation and technology, with customer and user needs, present and future, driving our technological advancements. You can be assured that with James Heal, you will always receive the highest levels of product quality and customer service. We have Agents and Distribution partners all over the globe, ensuring locally available product whenever, and wherever you need it.

Areas of Expertise

Textile: Colour Fastness

- Chlorinated Water
- Dry Cleaning
- Dry Heat
- Hot Pressing
- Laundering
- Light
- Perspiration
- Phenolic Yellowing
- Print Durability
- Rubbing
- Washing
- Water

Textile: Physical

- Abrasion
- Bursting Strength
- Compression and Puncture
- Crease and Wrinkle Recovery
- Crimp
- Drape
- Durability
- Flammability
- Mass per unit area
- Pilling and Fuzzing
- Security of Attachments
- Seam Slippage
- Shrinkage
- Snagging
- Spray Rating
- Stretch and Recovery
- Surface Deterioration
- Tear Strength
- Tensile Strength
- Washing and Drying

Non-Textile

- Bursting strength of nonwovens, plastics, paper and medical products
- Micro-scratching of laminates, wooden, painted, automotive and high gloss surfaces
- Physical and colour fastness testing of leather
- Rubbing fastness of laminates and wooden surfaces
- Tear strength of paper and plastic

1. INTRODUCTION

1.1. TruRain – Water Repellency Tester

The James Heal™ *TruRain Water Repellency Tester* is designed and built to test the water repellency of textiles by the Bundesmann rain-shower test.

Please read this operators guide before commencing installation and use of the TruRain instrument.

1.2. Features & Benefits

- Touchscreen user interface
- Standard Compliance - ISO 9865
- Automatic Water Deflector
- Replaceable Water Filter
- Audio and Light Alert
- Cup Jog Assist
- Removable Individual Cups
- Water Recirculation System

1.3. Service & Calibration

- Worldwide Service
- ISO 17025 based calibration service
- 18 Months' Warranty

1.4. Technical Assistance

- Operator training
- Knowledge transfer
- Applications support
- Engineering support

1.5. Standards

- ISO 9865 Textiles – Determination of water repellency of fabrics by the Bundesmann rain-shower test

2. GENERAL INFORMATION

2.1.

Manufactured by:

James Heal™
Richmond Works
Lake View
Halifax
HX3 6EP

Telephone No: 01422 366355

This manual is valid for the James Heal™ TruRain Water Repellency Tester.

This manual covers the operation and day to day maintenance for the James Heal™ TruRain Water Repellency Tester. It has been written and illustrated using the best possible information at the time of publication. The manual should be regarded as part of the equipment and should be kept with it throughout its working life.

Any difference between the manual and the equipment reflects improvements introduced after the publication of the manual. Any amendments received should be recorded below and incorporated in the relevant part of the manual.

Changes, technical inaccuracies and typographical errors will be corrected in subsequent revisions.

As part of our policy for continuous product development and improvement, James Heal™ reserves the right to make changes in design and specification without notice.

2.2. Revision History

See front cover for Publication number, e.g., 290-1523-1\$A, B, C etc

Revision	Date	Originator	Details of Revision
A	25/11/2019	AC	Op Guide Created
B	17/03/2020	SEW	Further recirculation cleaning instructions added
C	21/03/2020	SEW	Accessories list amended
D	13/07/2020	SEW	Recirculation cleaning instructions & revision labels amended.
E	19/10/2020	GI	Machinery Directive removed from Declaration of Conformity
F	07/04/2021	SEW	Water Safety Plan sections added. To existing Recirculation System cleaning instruction
G	19/11/21	SEW	Added to customer responsibilities: 3.4.2 - Water system safety; 6.7.3 Recirculation system cleaning & disinfection, 6.7.4; Machine drain-down procedure & 6.7.5 Draining the showerhead clauses added; WSP placement at 5.4.1 only.

2.3. EU & EC – Declaration of Conformity

In accordance with EN ISO 17050-1:2010

We hereby declare that the equipment described below confirms to relevant European Community Safety and Health regulations with respect to its design, fabrication and serial production. Use of this equipment for any other purpose than for which it has been designed and/or unauthorised modification of this equipment renders this declaration invalid.

Type of Equipment: James Heal™ TruRain Water Repellency Tester

Authorised Application:

Serial Number (s): 1930/19/1000 & upwards

The above product conforms to the essential requirements of the following EU & EC Directive(s) when installed in accordance with the installation instructions contained in the product documentation.

Relevant EC Regulations:

2014/35/EU **The Low Voltage Directive**
2014/30/EU **The Electromagnetic Compatibility Directive**

Applied Harmonised Standards:

<i>Ref. No</i>	<i>Title</i>	<i>Edition/date</i>
EN 61010-1	Safety requirements for electrical equipment for measurement, control, and laboratory use. General requirements	2010+A1:2019
EN 61326-1	Electromagnetic Compatibility (EMC) equipment for measurement, control and laboratory use.	2013

Referenced Standards:

<i>Ref. No</i>	<i>Title</i>	<i>Edition/date</i>
EN 55011	Conducted emissions (150kHz-30MHz)	2009 +A1: 2017
EN 61000-3-2	Harmonic emissions Class A	2006 +A1: 2009 +A2: 2009
EN 61000-3-3	Flicker	2008
EN 61000-4-2	ESD	2009
EN 61000-4-3	Radiated Immunity	2006 +A2: 2010
EN 61000-4-4	EFT/B	2004 +A1: 2010
EN 61000-4-5	Surge	2006
EN 61000-4-6	Conducted RF Immunity	2009
EN 61000-4-11	Voltage dips and interruptions	2004

The technical file is available from our EU Headquarters:

Neil Pryke, Innovation Director, James Heal, Richmond Works, Halifax, UK, HX3 6EP

Manufacturer: James Heal™, Richmond Works, Lake View, Halifax, HX3 6EP

Date: 01/05/2019

2.4. General Description and Use of Equipment

The James Heal™ TruRain Water Repellency Tester is designed and built to test the water repellency of textiles by the Bundesmann rain-shower test.

Warning: The equipment must not be used for any purpose other than for that which it was intended.

2.4.1. Definition of Water Repellency

Repellency is the resistance of textile fabrics to absorb water.

3. SAFETY AND ENVIRONMENTAL PROTECTION SUMMARY

Note: All operators and customer maintenance personnel should familiarise themselves with this manual before using or servicing the equipment.

3.1. Safety Summary

Be aware of hazards on instrument indicated by this symbol 

Emergency Stop



This switch is designed to bring the drive mechanism to an immediate halt in an emergency situation.

When pressed the switch will latch in the stop position.

To unlock the switch, twist the red cap in a clockwise direction.

Attempting to start a test with the switch in the stop position will result in a warning message being displayed.

Warning! The safety switch and emergency stop buttons merely stop the machine - they do not isolate it from the electrical supply.

Test Area and Moving Components – Warning

Moving components such as the cup carousel and rain shower guard represent crush and entanglement risks. It is important that users of the equipment understand these features and residual risks. Stand clear and do not reach into the test area when testing has commenced.

Be aware of the water flow gauge, water flow adjustment handle and walls of the instrument when interacting with the test area.

⚠ Touch Screen – Warning

Ensure the touch screen is locked when interacting with the test area. Preventing jog activation, rotating the cup carousel.

⚠ Cup Handling – Warning

Cup brass gear drive is sharp, keep hands away from the sharp edges of the gear drive. The cups should be removed one at a time to reduce strain.

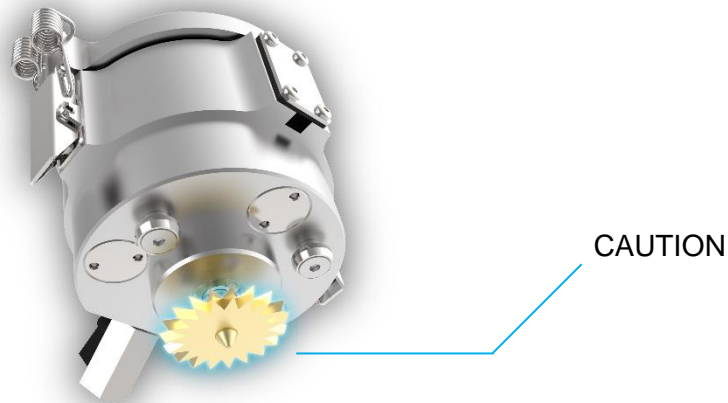

⚠ Water in System – Warning

Regular cleaning of the system is required to prevent the risk of waterborne diseases such as Legionnaires'. See 3.4.1 Cleaning & Maintenance for further details on how to clean the system.

⚠ Electric Shock – Warning

No access or removal of guards or panels by operators, only by qualified and trained personnel. If users see exposed or damaged power cables do not use or touch the instrument and seek technical assistance.

Warranty – Warning

Do not remove any panels on the TruRain, with exception to the front left panel which covers the water filter (reference section 3.4.1 Cleaning and Maintenance) If other panels are tampered with this will invalidate your warranty.

Note: The equipment must only be operated in an environment with adequate lighting with no shadow or stroboscopic effects.

3.2. Safety Precautions



Warning

Always observe the following safety precautions.

Ensure electrical outlet is dedicated (no other equipment on the same circuit breaker).

Only the voltage indicated on the unit.

Serial No./Rating Plate is connected to the unit.

It is recommended that the mains electrical isolation switch be lockable and located in a visible position.

Do not operate processor with a damaged power cord until it has been examined and repaired by an authorised service representative.

Ensure power cord is protected from contact with hot surfaces.

The power cord must not be subject to foot or machine traffic and must not be placed on the floor without adequate protection.

Always have electric box covers in place when processor is plugged in and the mains isolator switch is ON.

Do not use an extension cord.

Do not defeat or bypass built-in equipment safety features.

Avoid placing hands or loose clothing near moving parts.

Any maintenance, servicing or adjustments must only be carried out by suitably skilled or properly instructed/supervised personnel.

Wear appropriate Personal Protective Equipment (PPE) when performing regular testing tasks and performing maintenance.

3.3. Operator Safety



Always isolate from the electrical supply before carrying out authorised maintenance work on the machine.

Access to the main electrical power isolator must not be obstructed.

The area around the machine should be kept clean, dry and clear of any waste material.

Any maintenance, servicing or adjustments must only be carried out by suitably skilled or properly instructed / supervised personnel.

Operators need to be aware of the locations of the Emergency Stop button which is located next to the touch screen.

3.4. Customer Responsibilities

3.4.1. Cleaning & Maintenance



Cleaning and maintenance should be only carried by trained/competent personnel.

Correct PPE used for cleaning needed to prevent burns to skin and eye damage when using cleaning agents.



Water in System – Warning

- Regular cleaning of the machine and its plumbing is required to prevent Legionnaires' Disease and other waterborne diseases.
- Use mild surface cleaners to maintain the external surfaces.
- Do not use harsh chemicals to clean the machine – see 6.7.3.A.1 for suggested system cleaning chemicals.
- Follow the system cleaning guidance & instructions.

3.4.2. Water system safety

- Before first use follow cleaning & disinfection procedure.
- If mains fed - System should be flushed through at least once per week for 3 mins.
- If using a re-circulation system – The system should be cleaned & disinfected weekly.
- If left inactive for periods greater than one week, clean & disinfect and fully drain down in-line with clause 6.7.3 B, 6.7.4 and 6.7.5 if using the recirculation system & clauses 6.7.4 and 6.7.5 if using mains water.
- Inspect filter quarterly & change if debris is evident or there are visual signs of contaminant.
- Conduct weekly routine visual inspections of the machine & tank (if applicable) to ensure all surfaces and components are in clean condition. If not, clean all surfaces and carry out system clean & disinfection where recirculating system used.
- Ensure all operatives working on this system do not have an impaired immune system.
- Ensure all local water safety regulations are adhered to.

3.4.3. Recirculation settings

Service engineers will setup the pump before delivery and will re-check the pressure on site. Please take note of the pump settings, avoid adjusting the settings on the re-circulation unit.

3.4.4. Filter Replacement and Cleaning

1. Regularly check the filter located under the left-hand maintenance panel for contaminant build up.

Ensure the power supply is switched off before removing front left panel.

Note: avoid touching or changing the water valve.

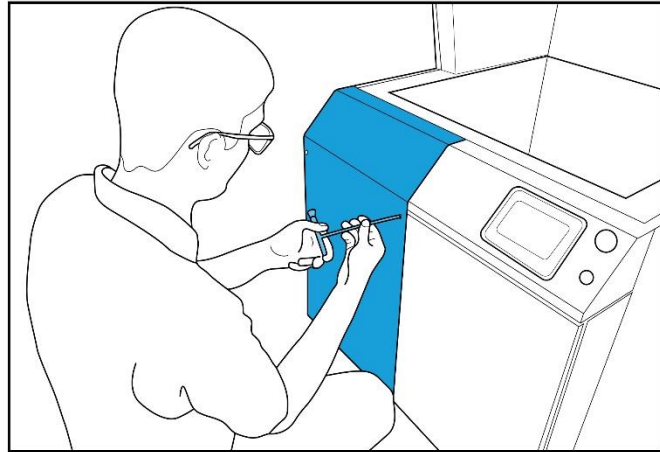

2. Using a 5mm Allen key to remove all four panel securing bolts, and carefully lift off the panel.

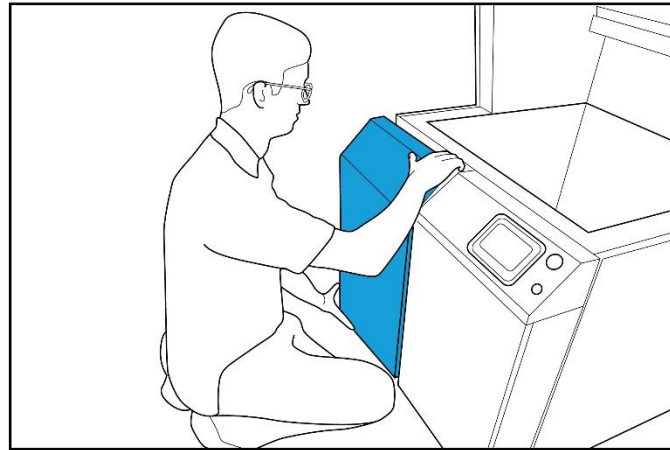

3. Place a container underneath the filter body to catch the water released when depressurizing the system.

Do not turn or remove the green pressure gauge knob, failure to do this will invalidate the machine's warranty.

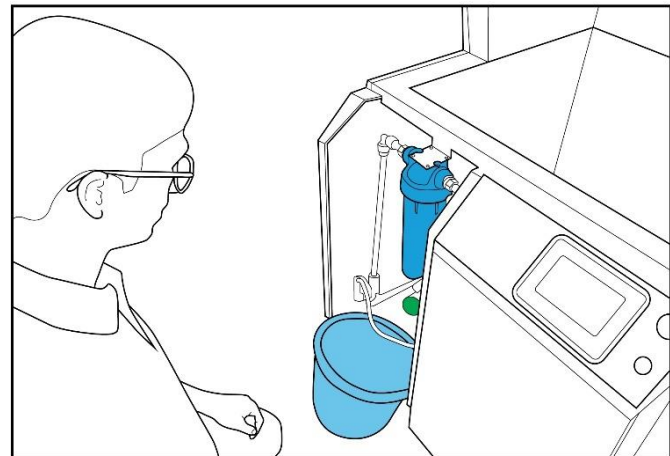

4. Press the red knob to release the pressure valve on the filter.

Water will escape from the valve as it is unscrewed.



5. Once the water has stopped running from the valve, unscrew the lower half of the blue water filter.

Loosen lower half using the hand tool provided.

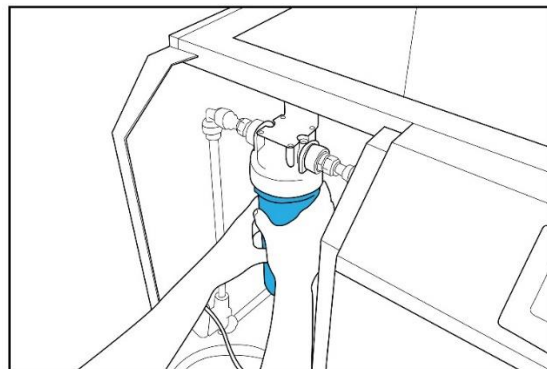
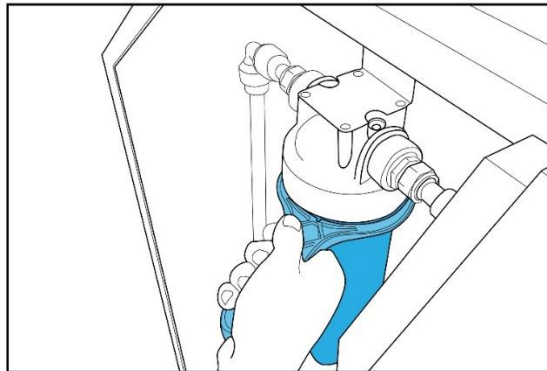

6. Extract the used filter and remove the centring ring from the body before cleaning or discarding

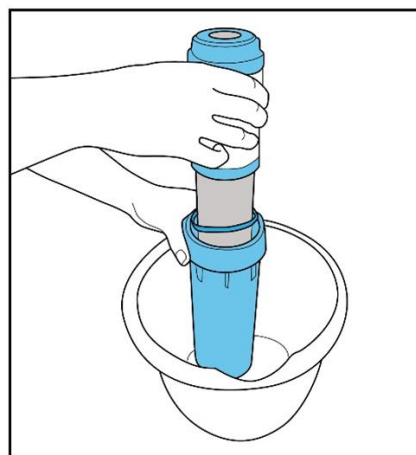

7. Do not throw away the centring ring.

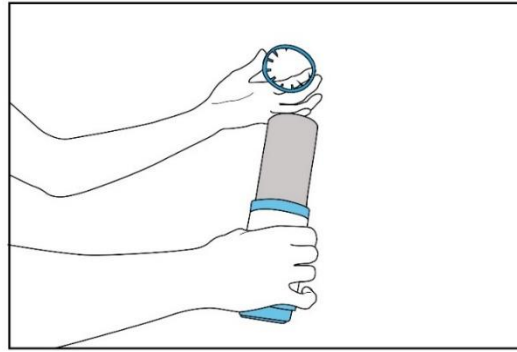

8. Place the centering ring on the replacement filter and insert the filter into the blue filter sleeve.

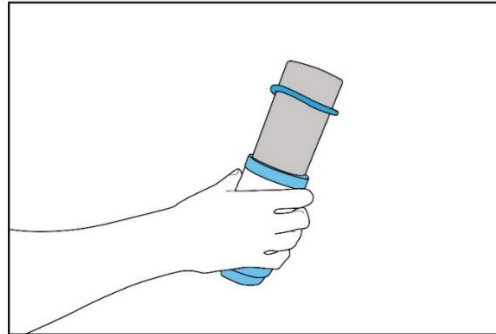

10. Screw the filter body back onto the unit.

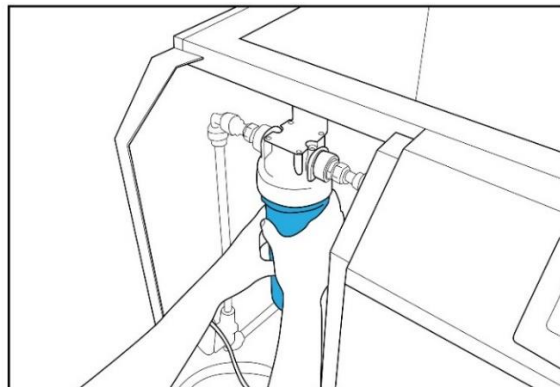

11. Tighten with the hand tool provided.

12. Ensure any water or debris is cleaned from the product area if spilled when replacing the filter.

13. Turn on and purge the system to ensure there is no leaking from the filter.

14. Place and secure the left panel back on the instrument.

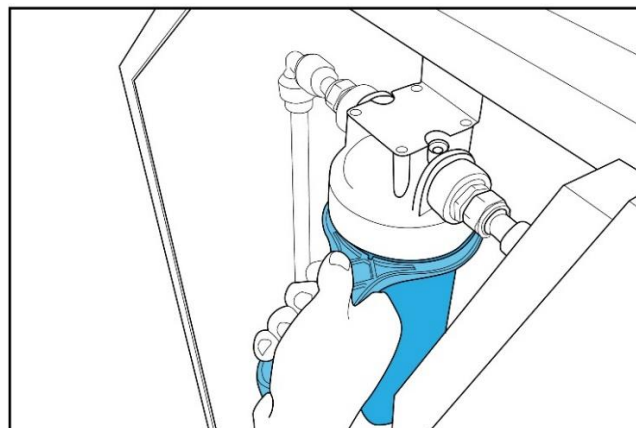

15. Follow the usual operation procedure in section 8 before commencing testing.

Purging the system

- Once the TruRain is powered on use the prime button to ensure the system is pressured. See section 7 for details on prime button on touch interface.

Drain Blockage

Regularly check the lint guard to prevent lint build up and system blockages.



3.4.5. Correct PPE

- Steel toe capped boots
- Eye Protection

3.5. Caution Labels

 Two Caution hazard labels feature either side of the instruments test area, warning users to be aware of potential hazards.

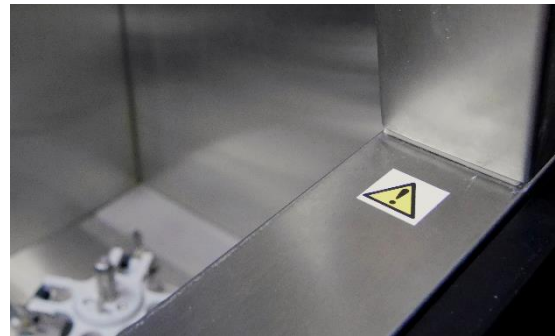

4. INSTRUMENT SPECIFICATION

	James Heal™ TruRain
Machine Only W x D x H (cm / inches) Weight (kg / lbs)	83 x 100 x 226cm 32.68 x 39.37 x 88.98" Combined Weight 262 kg 577.6 lbs Upper Half Weight 122 kg 268.96 lbs Lower Half Weight 140kg 308.65 lbs
Crated W x D x H (cm / inches)	Upper Half Crated: 163 x 103 x 97cm 64.17 x 40.55 x 38.20" Lower Half Crated: 117 x 102 x 121cm 46.06 x 40.16 x 47.64"
Electrical Requirements	Voltage: 110-240V Frequency: 50/60Hz Current: 0.5A Single Phase
Noise	1mtr 82dB

5. PRE-INSTALLATION

5.1. Preinstall Checklist

The TruRain is a large and heavy instrument. The following questions must be answered in the affirmative to allow safe installation of the instrument. If any questions are answered no please speak to James Heal.

1. The flooring around the TruRain final location has a weight bearing capacity of at least 262kgs.
2. The final location for the TruRain has at least 3100mm of head room for a Tower Hoist or forklift truck to operate safely.
3. Every doorway the TruRain must get through to be installed is at least 820mm wide and there are no obstacles along the route such as stairs etc.
4. The TruRain installation team has access to a genie lift or forklift truck (300kg min lift) and a 2-legged wire rope sling to lift part of the machine.

5.2. Customer Responsibilities

The James Heal™ TruRain Water Repellency Tester unit is shipped in two crates. The contents of which will need to be transported to the build site by James Heal or associated agent.

James Heal or associated agent will install this instrument, we advise all installers to be familiar with the Safe Working Procedure Document of the TruRain before commencing installation.

Prior to installation check content of delivery using with reference to Unpacking section 6.2.

James Heal will arrange shipment to your location but you are responsible for its safety before being moved to its final installation site, and for preparing the site to receive it.

General responsibilities include:

Providing James Heal with delivery instructions.



Having the necessary equipment and/or personnel for unloading the delivery vehicle and moving the equipment to its final site.

Preparing the installation site prior to the arrival of the instrument.

5.3. Delivery



Handling Equipment

Provide the necessary equipment, such as genie lift or forklift for unloading the unit.



Personnel

Provide personnel for unloading, unpacking and transferring the equipment.
Use professional riggers when necessary.

Clearance

Check the delivery route and remove all obstructions.

Lower Half of Unit

Minimum width: 822mm

Minimum height: 845mm

Minimum depth: 946mm

Minimum weight: 140kg

Upper Half of Unit

Minimum width:

Minimum height:

Minimum depth:

Minimum weight: 122kg

Elevator Capacity

Verify that the elevator will accept the specified weight of the equipment.

5.4. General Planning

Staging Area

Provide a sheltered staging area close to the installation site for unpacking the equipment.

Electrician

Have an electrician available to provide the necessary wall outlets, prior to installation.

Plumber

Have a plumber available to provide the necessary outlets, prior to installation.

5.4.1. Water Safety Plan

A Water Safety Plan (WSP) is a comprehensive plan that highlights all potential concerns and risks associated with a water system within a premises. For guidance see the British Standard BS 8680:2020, Water quality – Water safety plans – Code of Practice or the local equivalent. The World Health Organization (WHO) also provides advice & instruction on Water Safety Planning.



Ensure that where the local, national & international WSP regulations require, the TruRain & Recirculation System is included within it.



5.5. Area Planning

Room Layout

Provide adequate space for installing and operating the equipment. A minimum of 1000 mm/39.4" around the machine is recommended.

Room Height

Provide adequate space for installing and operating the equipment. A 3100mm working height.

Service Access

Provide adequate access to the equipment. A minimum of 820mm/32.3" in front of the machine is necessary to operate.

Floor Surface

Provide a stain and chemical resistant floor surface for ease of cleaning.

Floor levelling

The floor should be flat and level in both directions. The unit, however is equipped with adjustable legs and shower head to compensate for minor floor irregularities.

Floor Load-Bearing Capacity

The floor must be capable of supporting the operating weight of the equipment.

5.6. Electrical

Note: The electrical installation should conform to the codes and requirements of the country or locality in which the equipment is to be installed.

5.6.1. Electrical Specifications

Voltage: 110-240V

Frequency: 50/60Hz

Current: 0.5A

Single Phase

5.6.2. Power Cord

The equipment is provided with a 2 meters long power cord without plug, please request alternate length if required.

5.7. Water Re-circulation Unit Pre-installation

Ensure you have enough space to locate the water re-circulation unit within effective functioning distance of the TruRain.

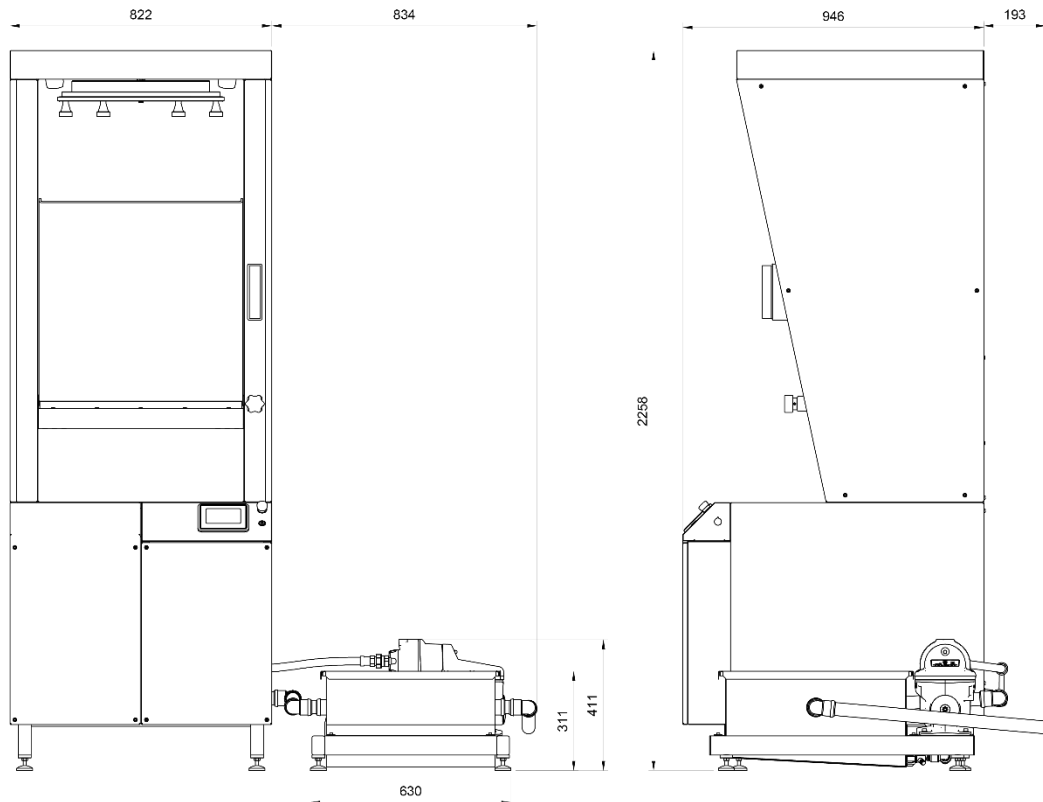

Power rating for Recirculation Unit

- Voltage: 200-240V
- Frequency: 50/60Hz
- Current: 2.8A

6. INSTALLATION

6.1. Receiving Inspection

Your James Heal™ TruRain Water Repellency Tester was carefully inspected and tested prior to shipment. Upon its arrival, inspect the crate for damage. Unpack the machine as soon as possible and conduct a thorough examination of the unit and its components. Do this in the presence of the carrier if at all possible. If damage is noted, take photographs of the damaged portions and immediately file a claim with the carrier. NOTE: If the carrier is not notified within 48 hours of delivery, he cannot be held responsible.



Warning

Beware of sharp edges, splinters, pinch points, exposed nails and staples when unpacking. Wear leather gloves.



Warning

Wear safety shoes, glasses and gloves when unpacking the equipment. Beware of sharp edges, splinters, pinch points, exposed nails and staples.

6.2. Unpacking

6.2.1. Unpacking Checklist

List of components/assemblies that will be delivered:

Stock Code	Item name	Quantity	Box
510-676	TruRain Upper	1	-
510-673	TruRain Lower (Tank)	1	-
510-615	Rain shower Head Assembly (packed in tank)	1	A
510-378	TruRain Test Cups (packed in tank)	4	B
510-424/425/426	TruRain Cup Clamp Rings (packed in tank) 3 sets - different sizes	12	B
510-396	TruRain Cup Carousel (packed in tank)	1	C

6.3. Moving the machine

Warning

Care must be taken to ensure that forklift operator is aware of all persons working around the equipment.

Warning

Personal Protective Equipment must be worn, safety shoes and non-slip gloves.

Provide adequate space for installing and operating the equipment.

The floor must be flat and level and capable of supporting the operating weight of the equipment, the unit is equipped with adjustable feet to compensate for minor floor irregularities. The floor should be stain and chemical resistant.

 The equipment is heavy. Use sufficient personnel and/or lifting devices for its movement. Provide the necessary equipment, such as forklift for unloading the unit and lift from the points, taking note of the centre of gravity to ensure the lift is effected in a safe manner.

6.4. Lifting points

A genie super lift is to be for this procedure to ensure a safe installation.

Use slings or 2-legged sling as shown to lift the upper section.

A forklift / pump truck can be used to move the lower section of the machine around. When placing forklift underneath be careful not to catch the pulley and drive belt.



6.5. Installation Procedure

 If the final destination of the TruRain is easily accessed move the two halves of the machine to assembly/installation area. If in doubt wait for the James Heal installation operatives to assist with the move and final setup of the instrument.

Instructions on Levelling the TruRain Instrument.

- Once the two halves of the instrument have been securely fastened and the TruRain is in its final position for its use. Level the Instrument.
- This can be completed by, adjusting the feet of the unit.
- Use a level on both to check the cup carousel and the upper edge of the test areas are level.
- Once the base is complete, move to next faze to level the rain head.



TruRain Rain Head Adjustment

- Using the thumb screws on top/outer roof of the TruRain, use the three thumb screws to refine the level of the shower head.



- Once the true rain has been installed, power on and purge the system. (refer to section 8 for operation)
- Once water is running consistently across all the individual rain heads.
- Check flow rate is correct (8.1 Test Preparation)

6.6. Connections Preparation

6.6.1. Electrical

- Stand the instrument on a firm and level surface.
- Connect the electrical power supply to the mains input using the lead provided.

Power rating for **TruRain**:

- Voltage: 110-240V
- Frequency: 50/60Hz
- Current: 0.5A
- Single Phase

6.6.2. Water

Water (*Potable*)

Water Outlet / Drain Size: 3/4" BSP

Water Inlet: 15mm Push Fit Swivel Elbow

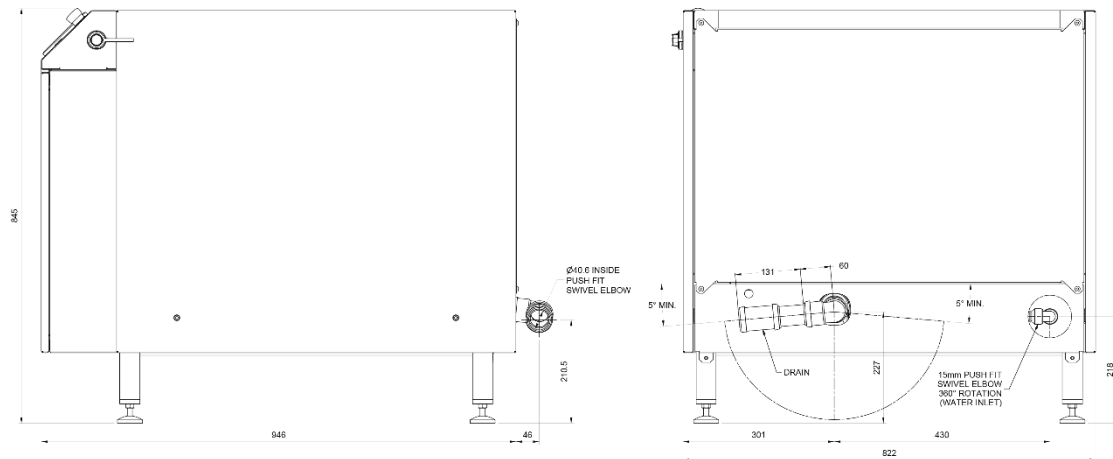

6.6.3. Water recirculation Installation



Once the recirculation system has been installed you will be able to power on and off the pump using the power button. The pump should display the pre-set information displayed in the diagram to the left.

If any other icons are highlighted please refer to SCALA2 Grundfos literature, supplied with the recirculation device.

Power rating for Recirculation Unit

- Voltage: 200-240V
- Frequency: 50/60Hz
- Current: 2.8A

6.7. System Settings

6.7.1. Water Pressure Settings

System pressure – Pre-set at 2 bar

Flowmeter adjustment is not an 'on, off' type control once adjusted it will need to settle for around 5 minutes then a cup test will need to be performed 200ml in 2.5 minutes +/- 10ml. (follow operation guidance section 8.)



6.7.2. Recirculation settings

Service engineers will setup the pump before delivery and will re-check the pressure on site. Please take note of the pump settings, avoid adjusting the settings on the re-circulation unit.

6.7.3. Recirculation system cleaning & disinfection



- i. When the system is filled for over one week, whether in use or not, the system must be completely cleaned, drained down and the tank fully emptied at least every 7 days.
- ii. When using for short and intermittent test runs of less than one week, always fully clean, drain down the system and empty the tank before the first test and last test.
- iii. Never leave water in the system or tank for over one week without either fully cleaning the system and renewing the water or completely cleaning, draining down the system and draining the tank.
- iv. Always keep the tank cover on and the overflow screen clean and in place.



The following procedures outline how to conduct the cleaning & disinfection regimens:

A. PRE USE

1.  Clean the recirculation system using a sterilising solution of 50ppm chlorine being very careful to follow the manufacturer's instructions.
2. Make up 23 litres of this solution and pour into the tank & run the system on purge ensuring the shower guard is on and the pressure gauge is fully open.
3. Once completed, fully drain the system & ensure the tank is emptied.
4. If after first disinfection cycle the water quality in the tank is visually unsatisfactory repeat procedures 2 to 3.
5. Rinse the system through with 23 litres of potable water (we recommend deionised water to minimise calcium carbonate deposit build up) run the system on purge ensuring the shower guard is on.
6. Once completed, fully drain the system & ensure the tank is emptied..
7. Rinse system through with potable water.
8. Once completed, fully drain the system & ensure the tank is emptied.
9. Fill the system with 23 litres of potable water (we recommend deionised water to minimise calcium carbonate deposit build up) ready for testing.

B. POST USE

1.  Clean the recirculation system using a sterilising fluid diluted to 50ppm of available chlorine solution. Be very careful to follow the manufacturer's instructions when making up the solution.
2. Drain the test water from the tank.
3. Make up 23 litres of the sterilising fluid diluted to 50ppm of available chlorine solution and pour into the tank.
4. Run the system on purge ensuring the shower guard is on and the pressure gauge is fully open.
5. Once completed, fully drain the system & ensure the tank is emptied.
6. If after first disinfection cycle if the water quality in the tank is visually unsatisfactory repeat procedures 2 to 5 until it is.
7. Rinse the system through with 23 litres of potable water (we recommend deionised water to minimise calcium carbonate deposit build up) run the system on purge ensuring the shower guard is on.
8. Once completed, fully drain the system & ensure the tank is emptied.
9. Rinse system through with potable water.
10. Once completed, depressurize the tank pump.
11. Completely drain down the system & showerhead see clauses 6.7.4 & 6.7.5.



WHEN USING STERILISING LIQUID:

- A) Follow the manufacturer's instructions for safety, cleaning and dilution.
- B) Ensure it is handled & used only by trained/competent personnel.
- C) Correct PPE used for cleaning needed to prevent burns to skin and eye damage when using this as a cleaning agent.

6.7.4. Machine drain-down procedure

1. Ensure the power supply is switched off before removing front left panel.

Note: avoid touching or changing the water valve.

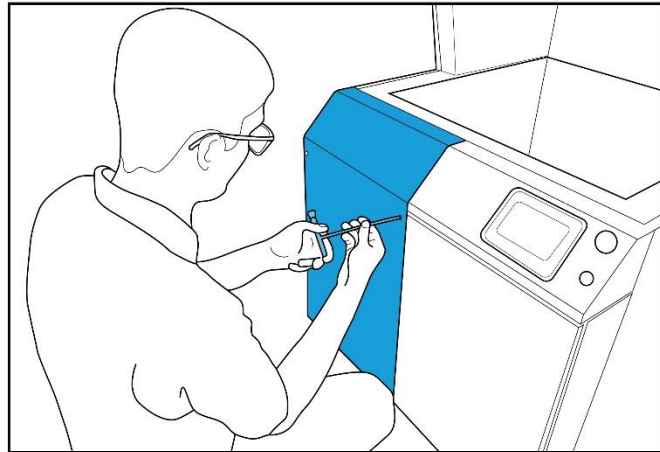

2. Using a 5mm Allen key to remove all four panel securing bolts, and carefully lift off the panel.

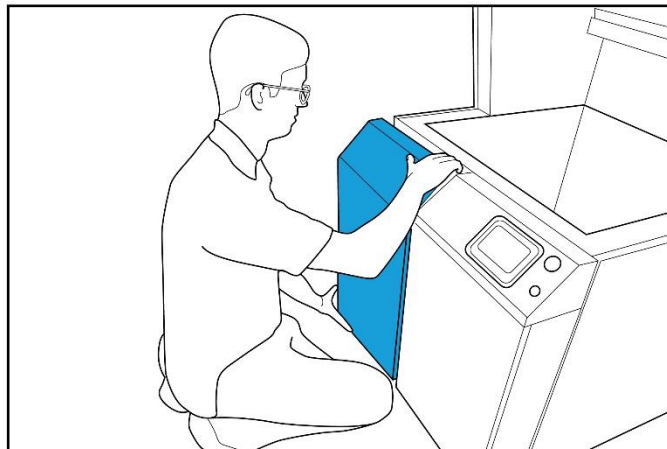

3. Place a bucket underneath the filter body to catch the water released when depressurizing the system.

Do not turn or remove the green pressure gauge knob, failure to do this will invalidate the machine's warranty.

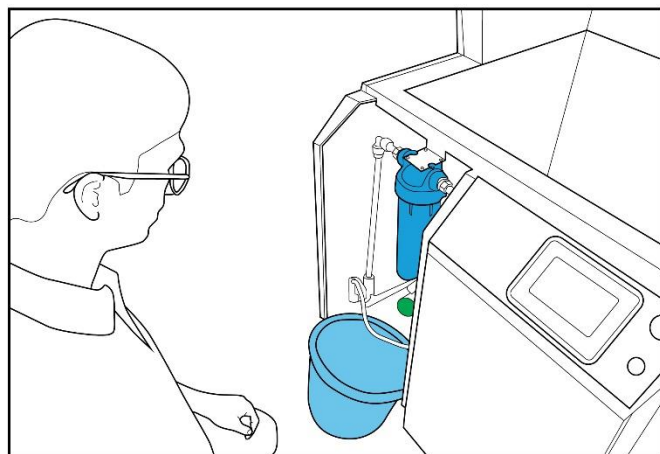

4. Press the red knob to release the pressure valve on the filter.

Water will escape from the valve as it is unscrewed.



5. Once the water has stopped running from the valve, unscrew the lower half of the blue water filter.

Loosen lower half using the hand tool provided.

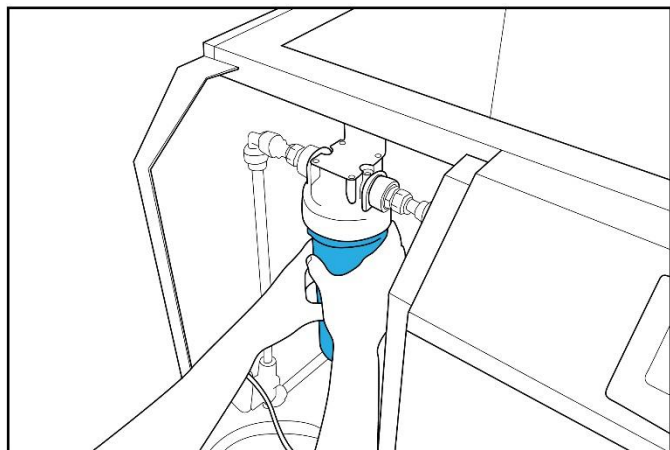
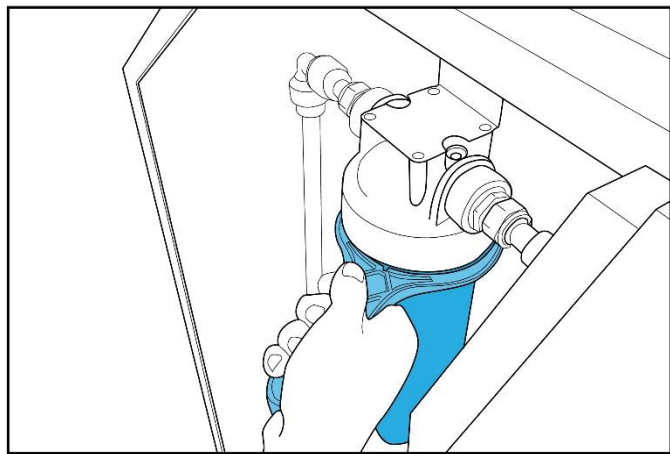

6. Extract the used filter and remove the centring ring from the body before cleaning or discarding.

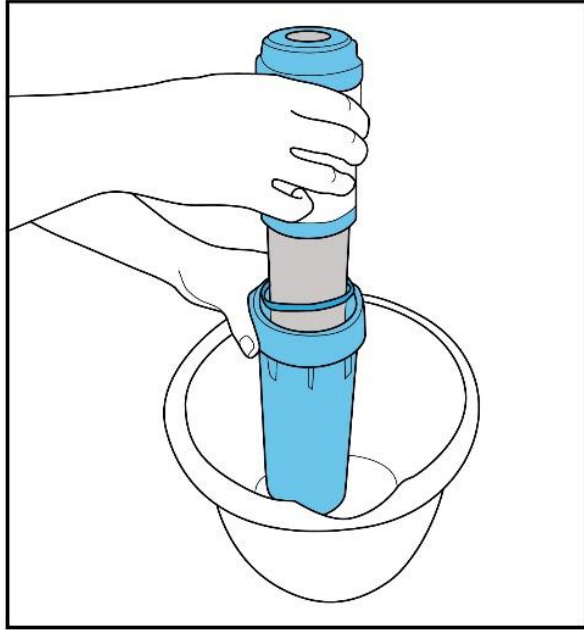

7. Do not throw away the centring ring.

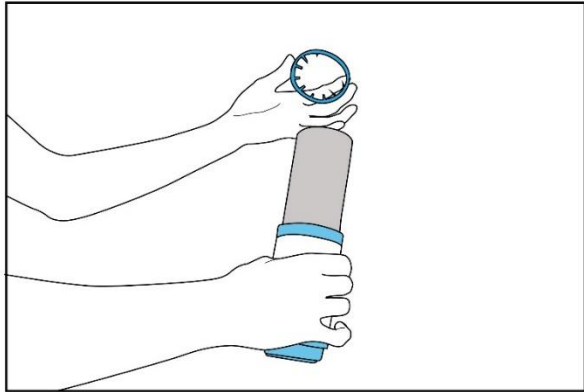

8. Place the centering ring on the replacement filter and insert the filter into the blue filter sleeve.

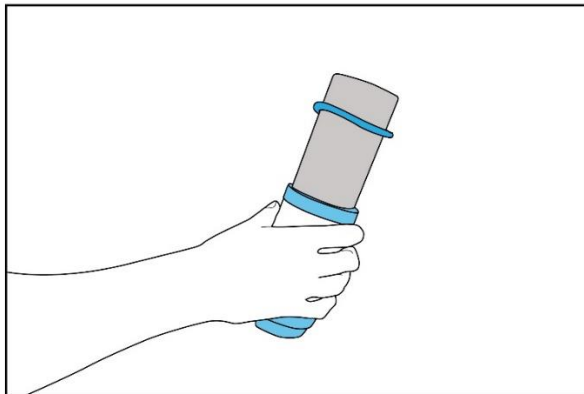

9. With the filter assembly now removed, ensure the bucket is still in place.

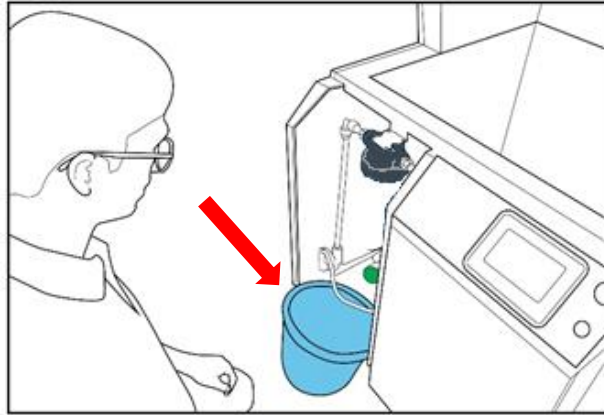

10. At the back of TruRain, blow compressed air through water inlet.

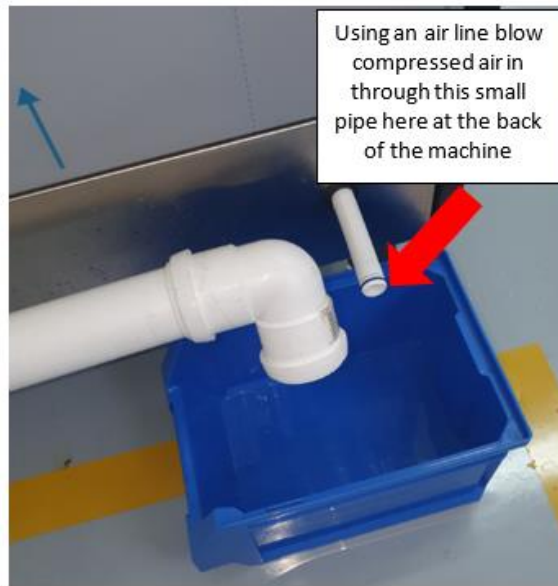

11. Any remaining water in this section of the system will run out at the front of the machine from the filter holder head into the bucket underneath.

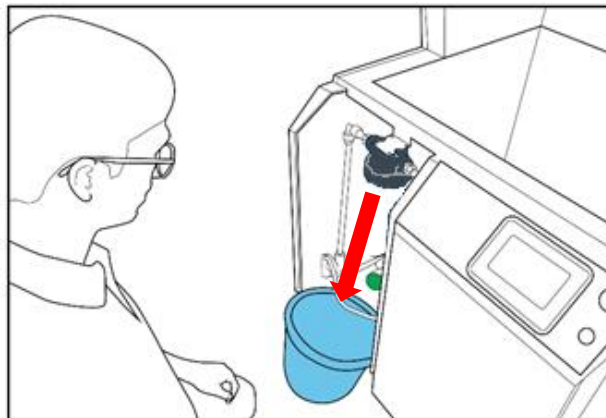

12. Next, insert the airline into the filter location hole inside the filter holder head.



13. Blow air through until water stops running through the shower head.

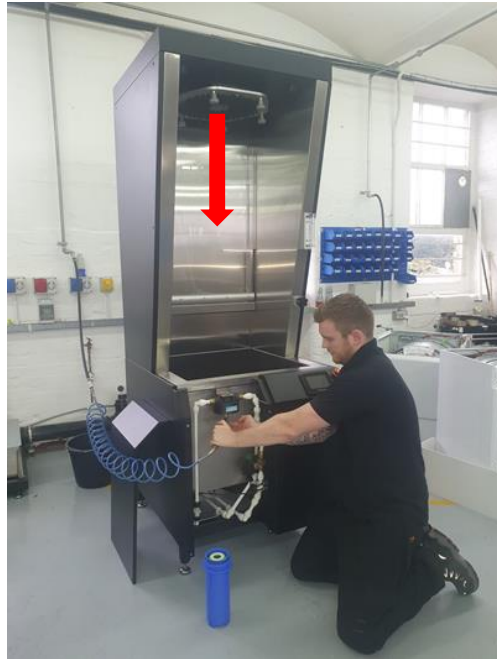

14. Screw the filter body back onto the unit.

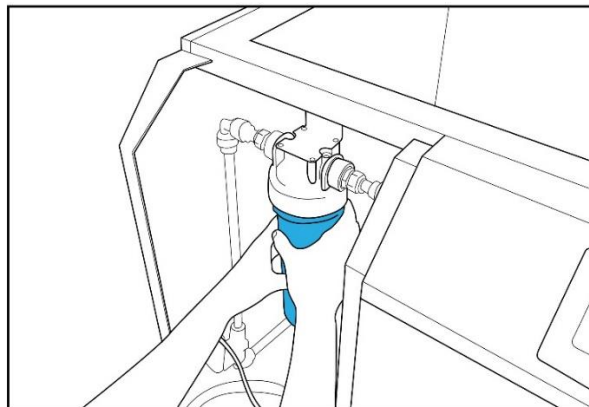

15. Tighten with the hand tool provided.

16. Ensure any water or debris is cleaned from the product area if spilled when replacing the filter.

17. Place and secure the left panel back on the instrument.

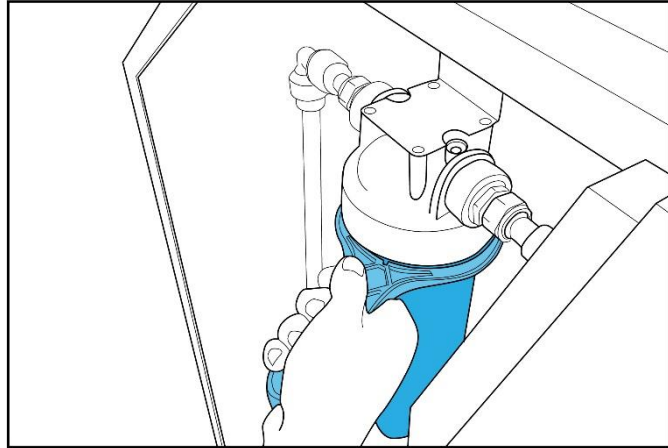

6.7.5. Draining the showerhead

1. The showerhead needs loosening slightly to allow it to drop down & forward to allow any sitting water to drain out once the drain screw is released. To do this follow the following instructions:



2. Following all relevant local Risk Assessment guidelines and Health & Safety directions & equipment. On the very top of the TruRain loosen the back & right showerhead knobs 2 full turns.

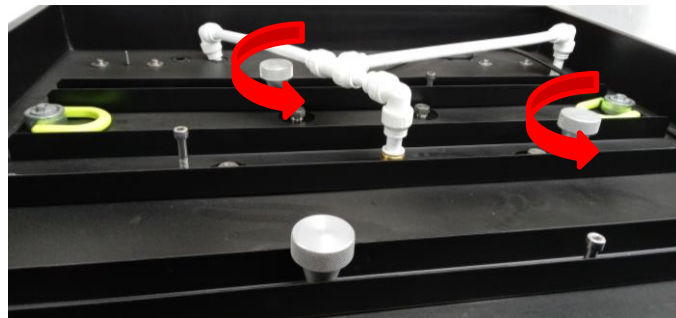

3. Following all relevant local Risk Assessment guidelines and Health & Safety directions & equipment. On the very top of the TruRain loosen the front showerhead knob 5 full turns.

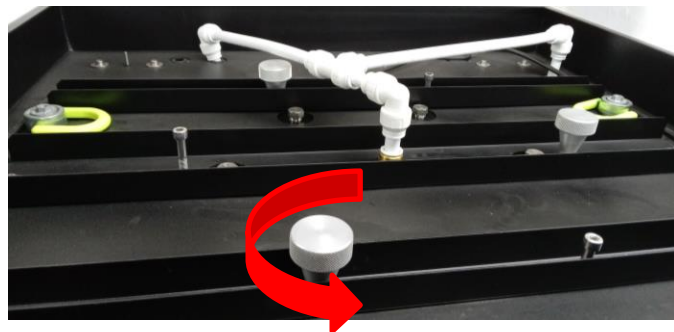

4. The front of the head will now drop down & forward a little.

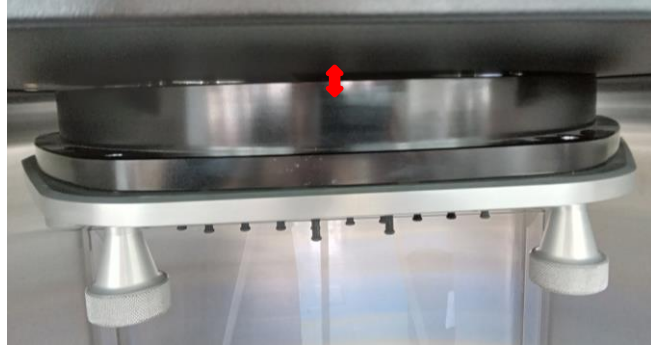

5. Using an Allen remove the drain screw fully to allow for any water to drain out.



6. Allow water to drain from the drain hole.



7. Once all the water has drained out, replace the drain screw.

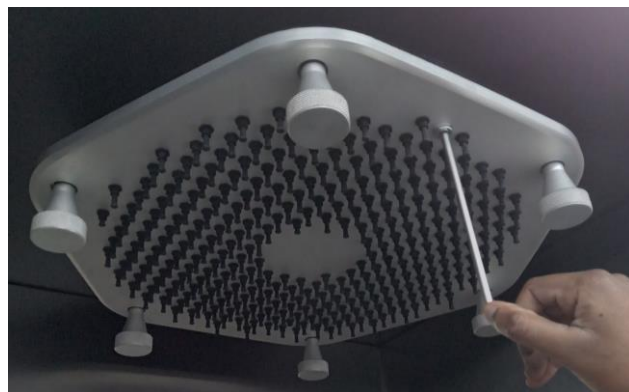

8. Following all relevant local Risk Assessment guidelines and Health & Safety directions & equipment. On the very top of the TruRain tighten the front showerhead knob 5 full turns.

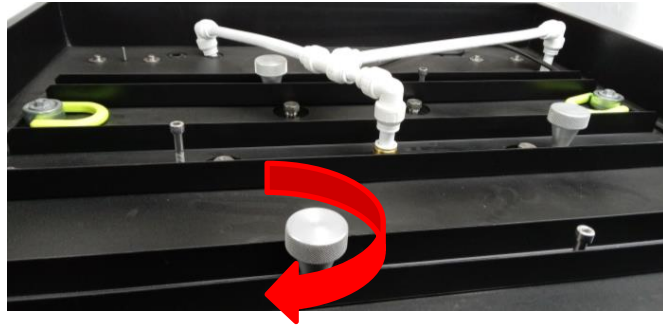

9. Following all relevant local Risk Assessment guidelines and Health & Safety directions & equipment. On the very top of the TruRain tighten the back & right showerhead knobs 2 full turns.

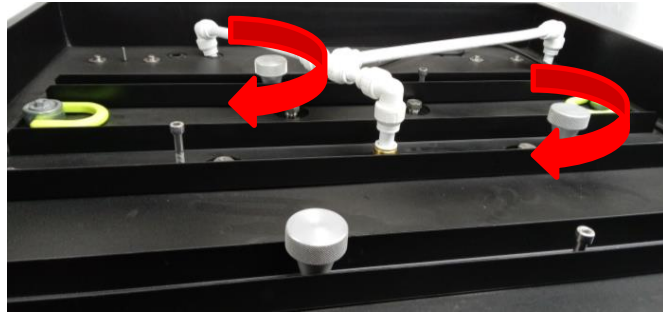

10. Take a spirit level along showerhead to check that the head is level again. If not, adjust the three knobs slightly to level it.



6.8. Spares and Accessories

Part Spares	Quantity Provided	Stock code
Nozzle Sleeve Flanged	5	374-343
Nozzle Insert Deep Grooves	20	374-345
Cup Clamp Rings	4 x 3	510-424/425/426
Water Filter Element	2	327-202
Mechanical Spares	-	Stock code
HTD Belt 800-8M-20	0	383-419
Electronic Spares	-	Stock code
RCBO 6A 2P 30mA Type B	0	110-384
Diode Standard 1N4002 100V DO41	0	122-513
Fuse 2A T 20x5mm	0	130-853
RELAY, PCB, SAFETY, 8A, 24V	0	152-554
RELAY MODULE, DPCO, 24VDC	0	152-560
EAO E-STOP WITH 1.5M LEAD	0	160-474
Pushbutton Mains Illuminated	0	160-506
480V Metal Oxide Radial Varistor	0	195-348

Optional Accessories	Quantity	Stock code
Centrifuge	-	794-350
Water recirculation system	-	510-662
1930 Spares	-	1930-Spares
Rain Shower Guard	-	510-680

6.9. Product Overview

6.9.1. External instrument components



6.9.2. Plumbing components

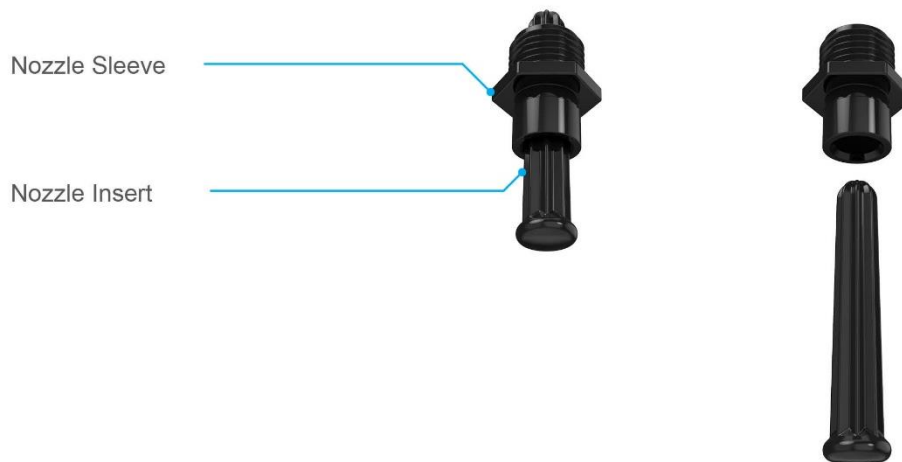

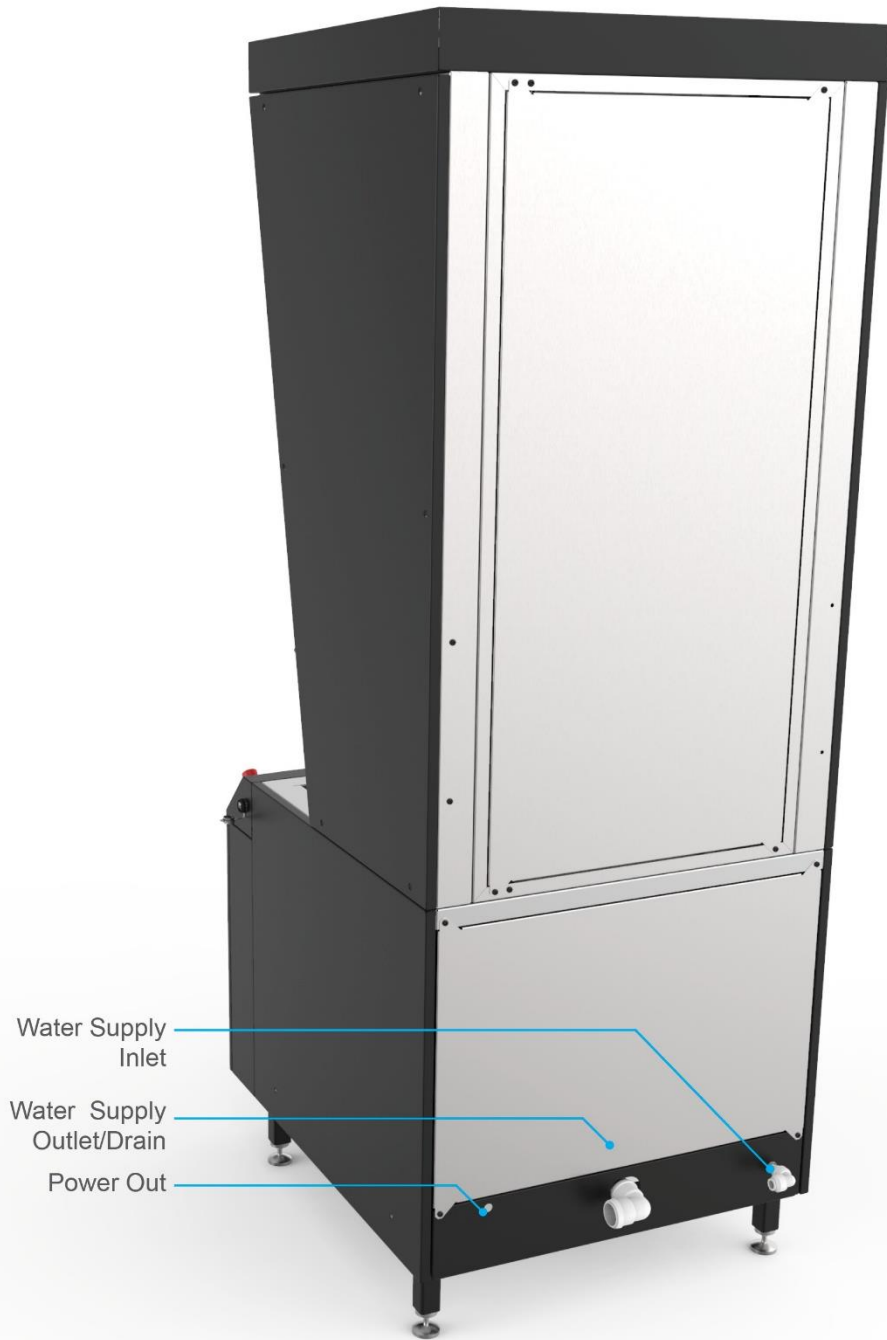

6.9.3. Carousel components

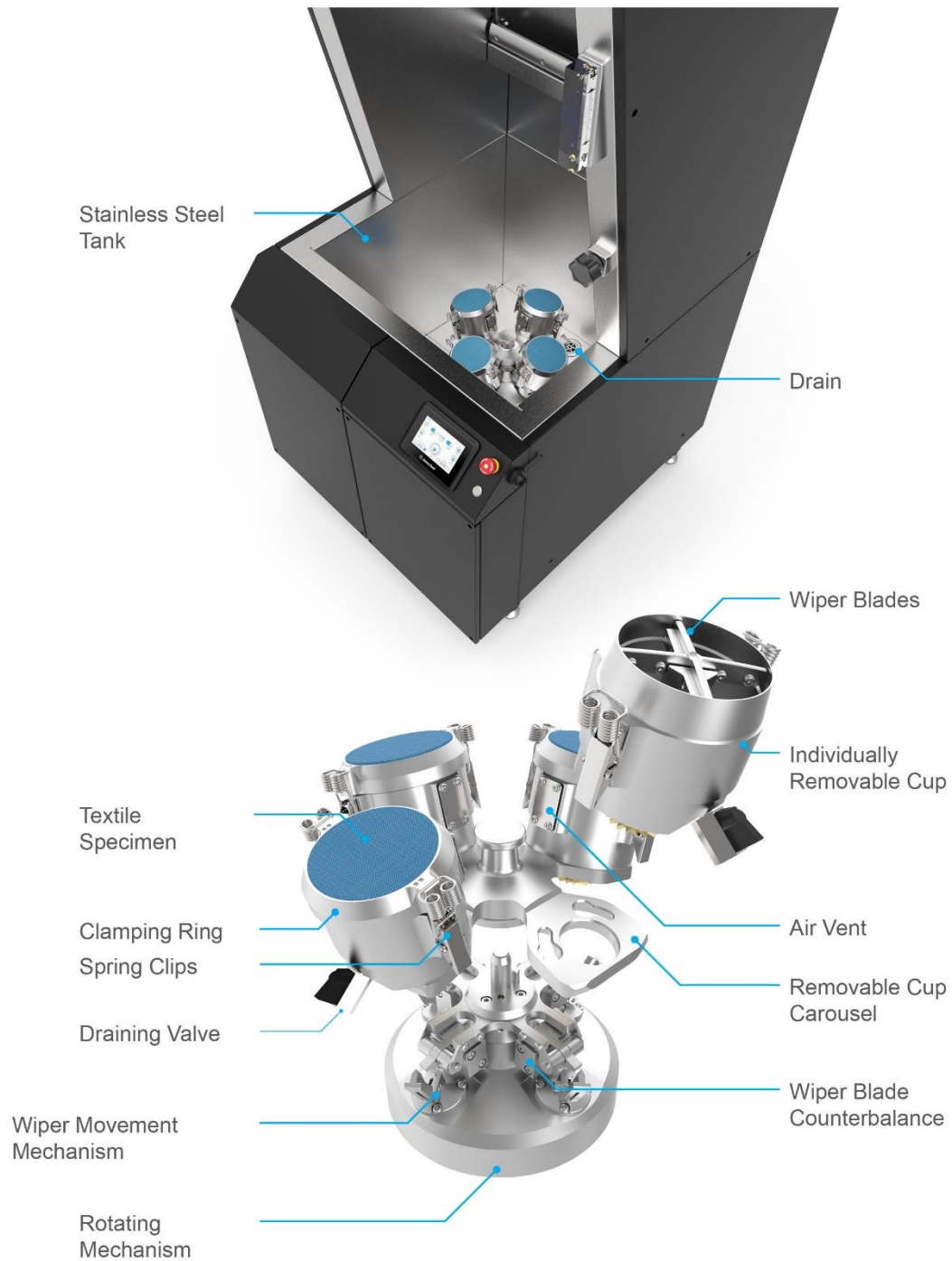

7. TOUCHSCREEN INTERFACE

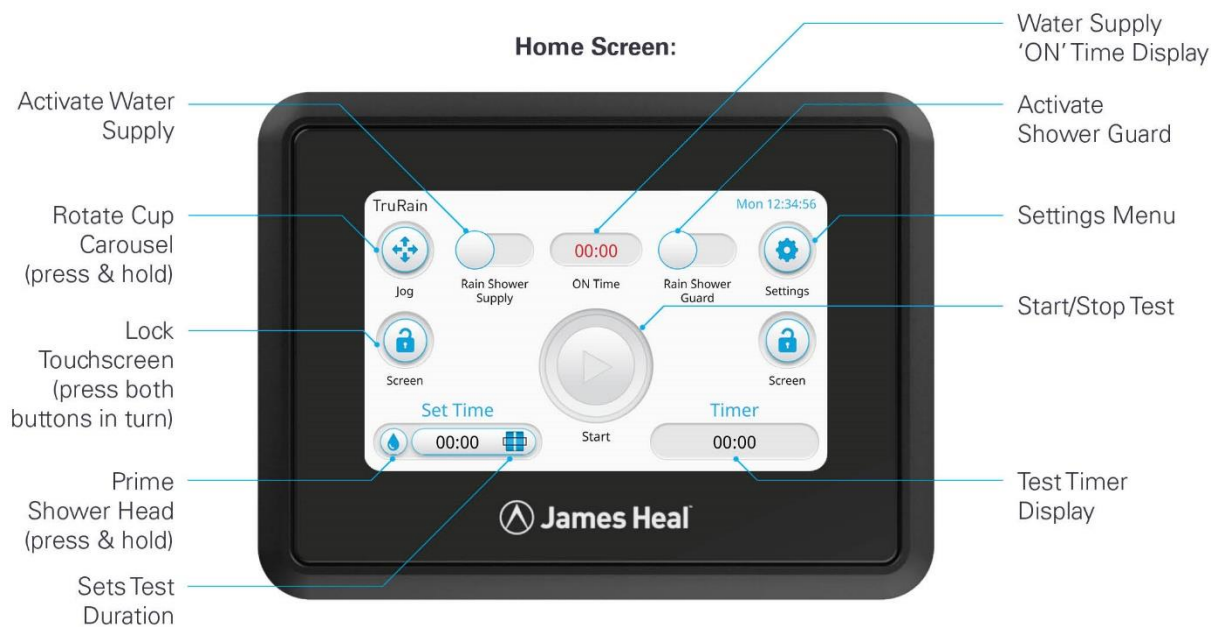

Rain Shower Supply: when toggled on, initiates the water supply, including a short priming sequence before the flow is automatically stabilised. When toggled off, stops the water supply.



Jog: rotates the Cup Carousel to allow easier access to each cup. The carousel will continue to rotate until the Jog button is pressed again.

Lock Touchscreen: to lock the screen first press the left lock button and then in quick succession press the right lock button. To unlock the screen, repeat the process in the same order. When locked all other buttons on the screen will be unavailable until the Lock buttons are pressed in sequence.

Prime Shower Head: when pressed, the water supply will “prime” i.e. the water flow will be increased, until the Prime button is pressed again (displayed as grey when active).

Set Time: opens timer dial for user to set the desired test duration.

Water Supply 'ON' Time Display: displays the length of the time the shower supply has been on for. Begins counting when the water supply is activated and resets when the water supply is turned off. Time numbers will remain red until 15 minutes has passed.



Shower Guard: when toggled on, lowers the Shower Guard to deflect the water supply away from the carousel towards the back of the instrument. When toggled off the Shower Guard returns to an upright position, exposing the carousel to the shower supply.

Settings Menu: opens the Settings Menu (see detail below).

Start/Stop: initiates/pauses/ends the testing sequence.

Test Timer Display: displays the length of the time the current test has been active for.

Settings Menu (General Tab):



Alarms Menu: opens Alarms menu. Up to 3 alarms can be set by selecting each timer in turn.

Prime Shower Head: when pressed, the water supply will “prime” i.e. the water flow will be increased, until the Prime button is pressed again (displayed as grey when active).

Volume: adjusts speaker volume.

Brightness: adjusts screen brightness.

Language: select preferred language.

Day/Time: allows user to alter the day/time to be displayed on the Home Screen.

Calibration Menu: for access by James Heal service engineers.

Auto Guard: when toggled on, the Shower Guard will automatically move to an upright position when the Start button is pressed on the Home Screen.

Auto Lock: when toggled on, the touchscreen will automatically lock when the Start button is pressed on the Home Screen.

Auto Calibrate: when toggled on, the calibration procedure will begin automatically after the shower supply has been on for 15 minutes.

Back: returns to Home Screen view.

8. OPERATION

TruRain must be connected to an appropriate power source and plumbing system before use – refer to Section 6.6 of this guide for further details.

When switched on using the on/off switch on the front of the machine, the lights at the top of the unit will illuminate and the touchscreen interface will display the Home Screen.

The following sections describe the operation and data analysis for TruRain testing in accordance with ISO 9865.

The rooms relative humidity should be no more $65 \pm 2\%$ and the ambient temperature should be no $20 \pm 2\text{ }^{\circ}\text{C}$ or $27 \pm 2\text{ }^{\circ}\text{C}$, as specified in ISO 139.

Warning

The interface has been pre-set to the operation of ISO 9865, proceed with caution when adjusting pre-sets.

8.1. Test preparation

1. Turn on the Rain Shower Guard to prevent water from landing on the cups.
2. Turn on the Rain Shower Supply.

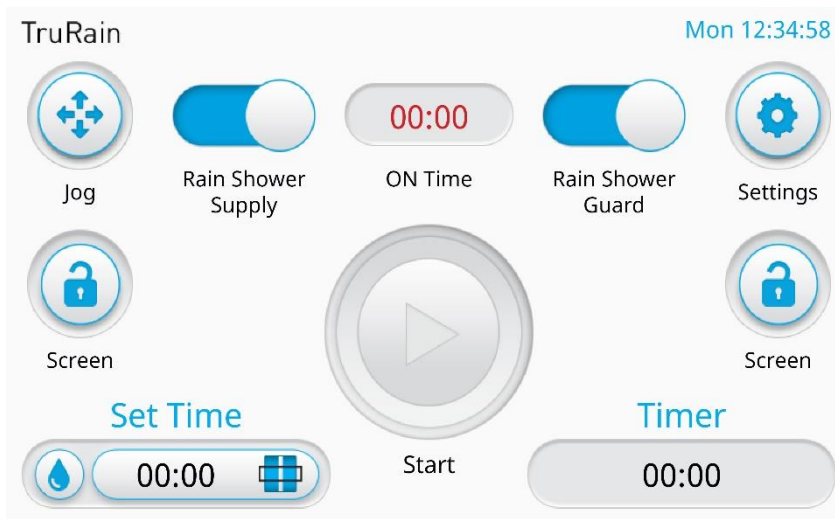

3. Before performing a test, the water supply must remain on for at least 15 minutes. The 'ON Time' counter on the touchscreen interface will be displayed in red until this time has elapsed.

4. A message will alert the user if they try to initiate a test in this 15 minute period to remind them they are deviating from the standard.

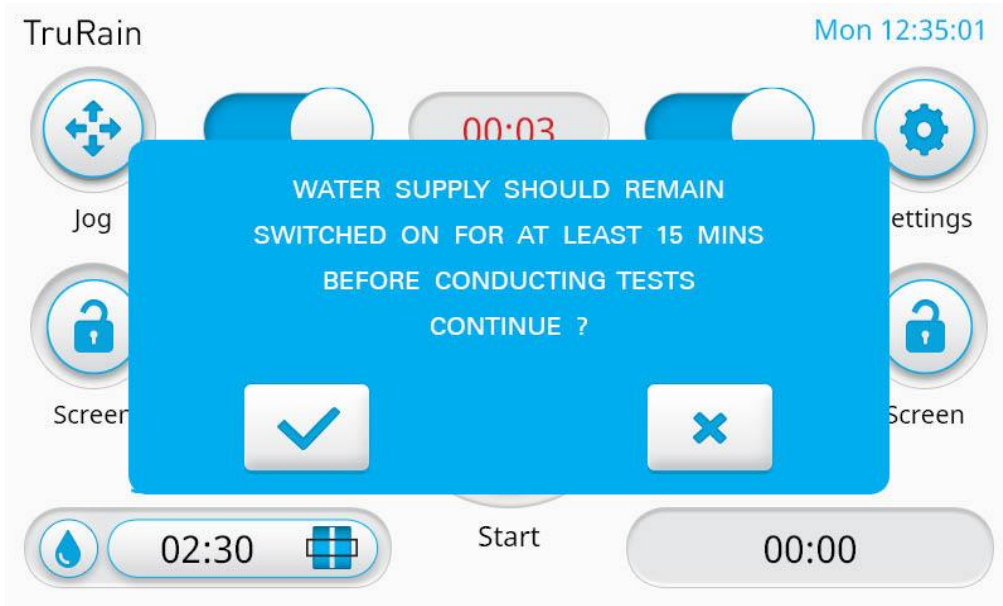

5. To ensure the drop forming nozzles are operating consistently and evenly the shower head must be primed. A priming procedure is automatically performed by the instrument when the Rain Shower Supply is turned on. The user can also press and hold the Priming button on the bottom left of the touchscreen to rapidly fill the shower head.

8.1.1. Flow rate calibration procedure

The rain shower flow rate must be calibrated before a test can be performed. ISO 9865 states that when the cups have been exposed to the rain shower for 2.5 minutes the volume of water captured in each cup should be 200 ± 10 ml. In continuous operation, calibrate the equipment at least twice every day.

1.  Turn on the Rain Shower Guard to prevent water from landing on the cups.
2. Turn on the Rain Shower Supply.

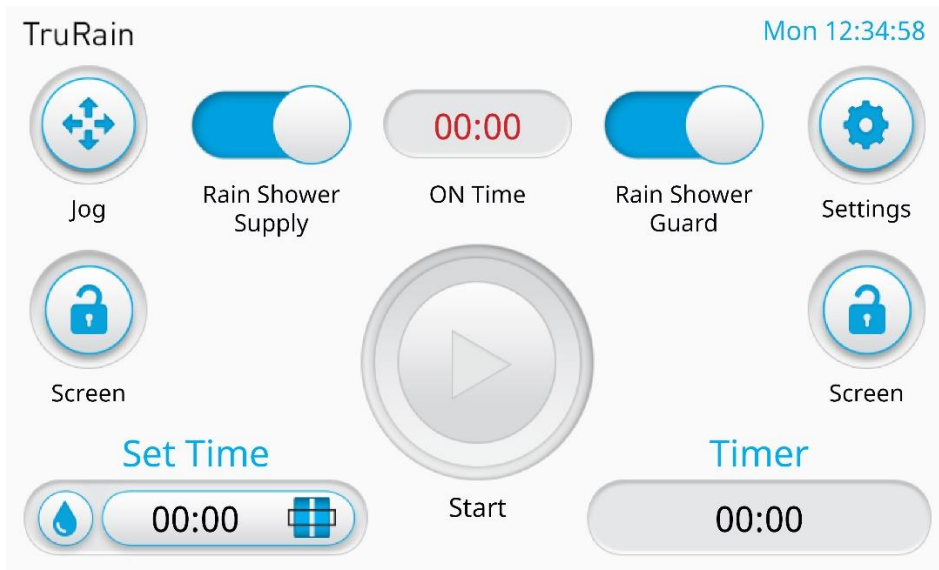

3. Follow the priming procedure to ensure all the nozzles are dripping consistently after 15 minutes of continuous water flow.
4. Adjust the flow rate by turning the Flow Adjustment Handle, using the Flow Meter to gauge the correct flow rate (it should be roughly 20 gph).
5. Set the timer on the touchscreen for 2 minutes 30 seconds.



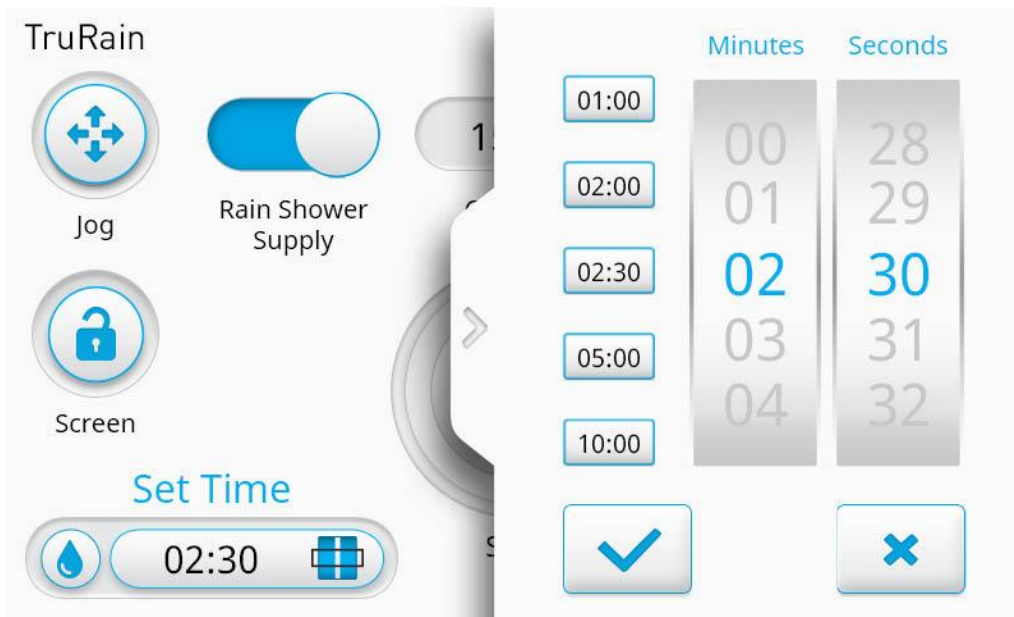

6.  Ensure the cups are all empty of any water and that each cup drainage valve is closed (the cups should not have specimens mounted on them during calibration). The Jog button can be pressed to rotate the carousel and improve access to the cups. All four cups can also be removed by lifting the cup carousel. Alternatively, the cups can be removed individually by twisting them to release the magnetic bayonet connection.
7. Press the Start button. The Shower Guard will automatically move into its vertical position exposing the cups to the Rain Shower (only if Auto Guard is turned on in the Settings Menu).
8. When the test has finished the Rain Shower Guard will automatically activate again (only if Auto Guard is turned on in the Settings Menu).
9. Measure the volume of water in each cup. The water can be released from the cup into a measuring vessel by opening the cup's draining valve.
10. If the water volume is out of tolerance the flow rate should be adjusted accordingly using the Flow Adjustment Handle. The previous steps should be repeated until it is within tolerance.
11. When the water volume is within tolerance the user can proceed with their test schedule.

Note

Please check the Fault Finding section (**10**) if correct volume of water is not achieved.

8.2. Test Procedure

1. Turn on the Rain Shower Guard to prevent water from landing on the cups.
2. Turn on the Rain Shower Supply.
3. Follow the priming procedure to ensure all nozzles are dripping consistently after 15 minutes of continuous water flow.
4. Set the correct flow rate by following the Flow Rate Calibration Procedure.
5. Prepare and condition 140 mm diameter test specimens in accordance with ISO 9865.
6. Weigh the test specimen to an accuracy of 0.01 g (dry mass m_1).
7. Ensure the cups are all empty of any water and that each cup drainage valve is closed. The Jog button can be pressed to rotate the carousel and improve access to the cups. All four cups can also be removed by lifting the cup carousel. Alternatively, the cups can be removed individually by twisting them to release the magnetic bayonet connection.
8. Identify the face of the specimen to be tested and place uppermost over the cups without any particular pre-tension, smoothing manually.
9. Place the clamp ring on top of the specimen and secure in place with spring clamps.

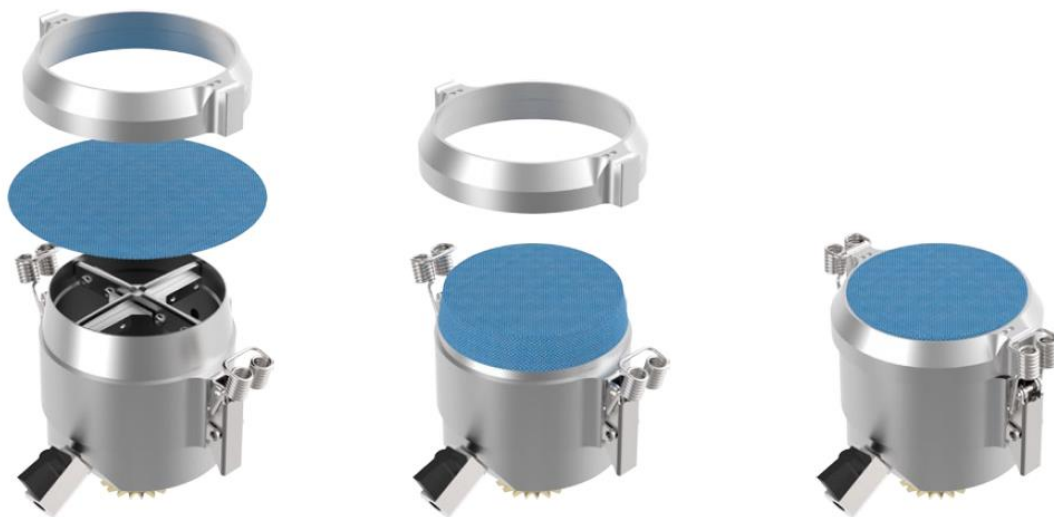

10. Repeat for up to four specimens and ensure that the carousel and cups are returned to the instrument.
11. Set the timer on the touchscreen for 10 minutes.

12. Set any alarms required from the Alarms Tab in the Settings Menu. For example alarms can be set for 1 minute and 5 minutes to prompt the user to visually assess the test specimens at these intervals in accordance with ISO 9865.

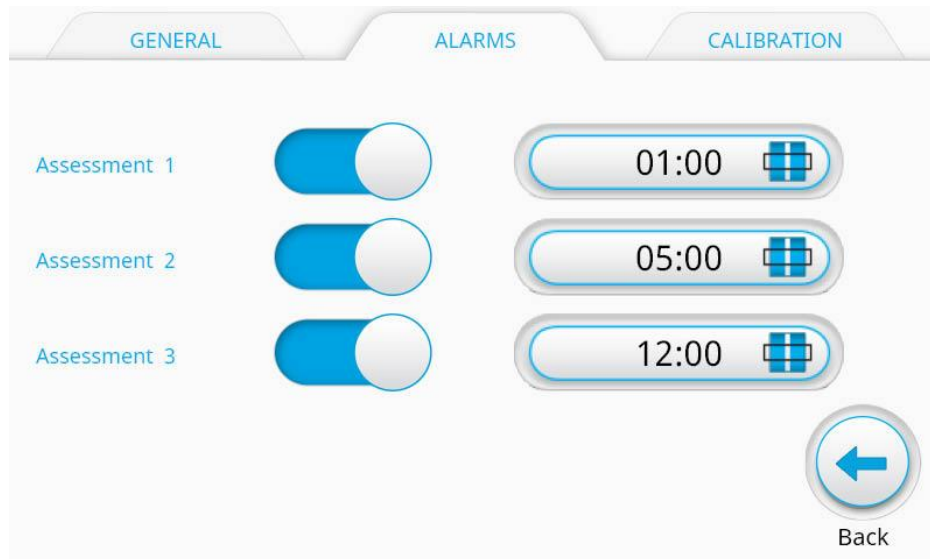

13. Press the Start button. The Rain Shower Guard will automatically move into its vertical position exposing the cups to the Rain Shower (only if Auto Guard is turned on in the Settings Menu).

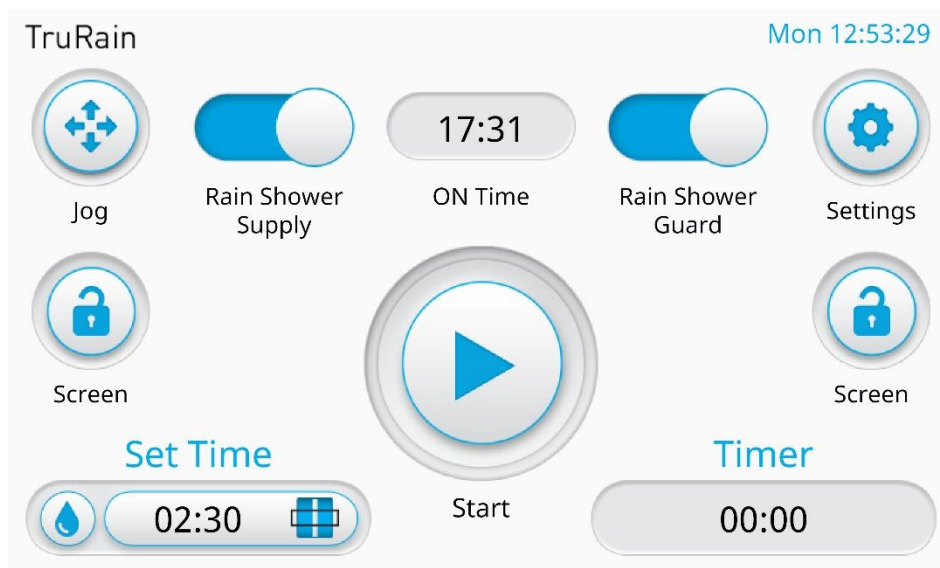

14. The lights at the top of the unit will flash and an audio cue will sound in accordance with any alarms that have been set, to prompt the user to visually assess the water repellency at these intervals.
15. When the test has finished the Rain Shower Guard will automatically activate again (only if Auto Guard is turned on in the Settings Menu).

9. RESULTS ANALYSIS

1. Assess the water repellency by visual comparison of the wet specimens at the end of the shower test with comparison to the reference photographs in accordance with ISO 9865.
2. Centrifuge the specimen for 15 seconds. Immediately afterwards, weigh the specimen to accuracy of 0.01 g (wet mass m_2).
3. Calculate the water absorption using the equation: $Absorption \% = \frac{m_2 - m_1}{m_1} \times 100$
4. Measure and record the volume of any water that has passed through the test specimen and collected in the cups.

10. FAULT FINDING

Fault	Probable Cause	Action
The equipment does not power on	No power supply to equipment	Check if plug is connected Check if power is switched on
Flow Meter	Water supply	Check if the unit has water pressure. Purge system, to ensure water is not being restricted. Clean system.
Screen not functioning	Water on Screen	Ensure the touch screen is dry and free from water.
Test Stopped and cannot be started.	Emergency-stop activated	Ensure the emergency-stop (red button) hasn't been activated, by twisting the button. The touch screen should also indicate that the e-stop is engaged.
Test area filling with water	Drain blockage	Refer to section 3.4.1. Cleaning & Maintenance
TruRain not Verifying	Level of Rain Shower Head	Ensure the TruRain is level refer to section 6.5. Installation Procedure
	Rain shower head blocked	Refer to section 3.4.1. Cleaning & Maintenance
	Filter blocked / replacement	Refer to section 3.4.1. Cleaning & Maintenance

Warning

If the above action does not resolve the problem or the problem is not listed, switch off the unit and call a qualified technician for assistance.

11. SERVICE & CALIBRATION

James Heal Service & Calibration is a totally comprehensive, worldwide support programme. When you buy instrumentation from us, it is the beginning rather than the end of an association.

Our aim is simple:

To provide precisely the services you need to maintain and protect the value of your investment.

For any enquires you may have regarding your instrument please contact James Heal Service & Calibration by e-mail, phone or fax.

In all communications, please quote the serial number of your instrument and the software version number, e.g., 1616/16/1001 and V1.00.

James Heal Service & Calibration contact details:

Telephone +44 (0) 1422 366355

11.1. Software

Please contact your installer or agent regarding software updates, or if you experience any bugs with your software.