

Project Name		Customer Name	
Quote Number		Date	
Customization			

Standard Features

Type	One-piece curbed shower stall
Color	White
Exterior Dimensions	48"W x 36-3/8"D x 79-1/4"H
Materials	Gel coat and fiberglass composite
Approximate Weight	135 lbs

Certifications and Accessibility Code Compliance



Universal
Plumbing Code



CSA B45.5-11 / IAPMO Z124-
2017



HUD / FHA

ANSI

ICC A117.1 - 2017
ANSI Type B

Curtain Rod Detail
(See Submittal Page 2)

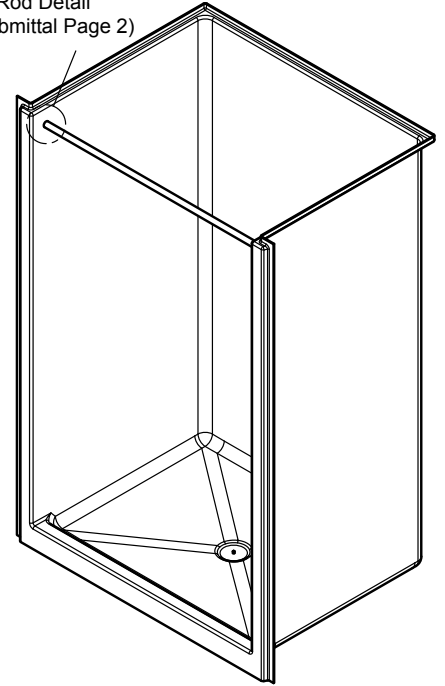

Warranty

30 Year Limited

Reinforcement

Fully reinforced with EverFab's unique composite core material according to FHA and ANSI Type B requirements

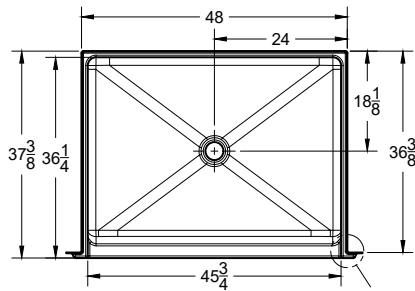

Return Flange Detail
(See Submittal Page 2)

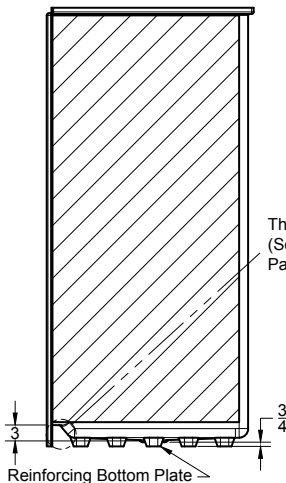
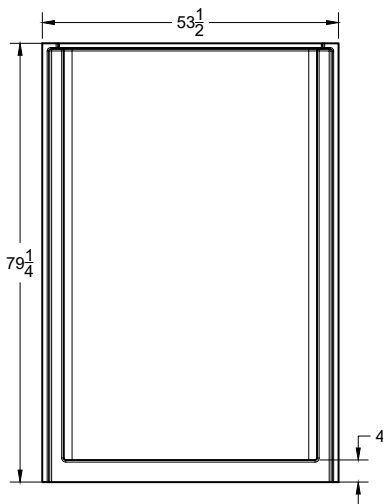

Threshold Detail
(See Submittal Page 2)

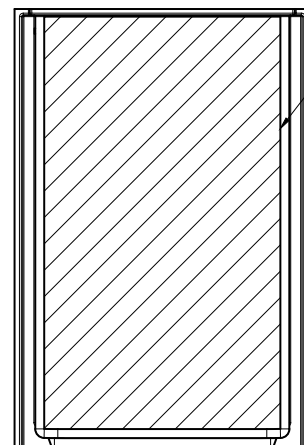

Fully reinforced with
EverFab core material
for factory or field
installation of grab bars
and seat

Additional Details

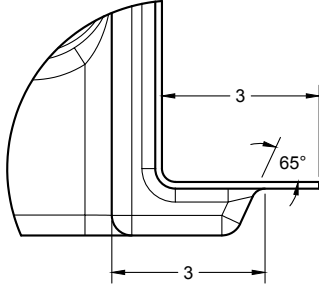

Return Flange

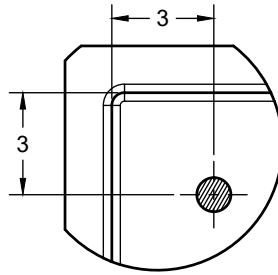

Standard Curtain Rod Location

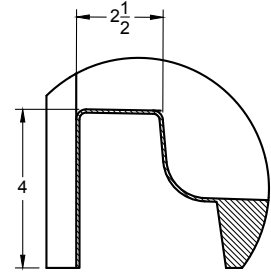

Threshold

Architectural Specifications

A. Shower Stall:

1. Model: No. S4836RFB
2. Description: One-piece shower stall with reinforcing bottom plate, slip-resistant floor, and inorganic composite reinforcement capable of meeting FHA and ANSI Type B accessibility requirements
3. Exterior dimensions: 48 inches wide x 36-3/8 inches deep x 79-1/4 inches high
4. Rough-in: +1/8" -0" nominal dimensions
5. Optional Accessories: Furnish with [curtain rod], [shower curtain], [recessed soap dish], [composite corner shelf], [shower slide-bar kit], [EverFab tub-wrap], [shower drain], [18" grab bar], [24" grab bar], [folding seat]. If applicable, please indicate location of additional accessories on drawing
6. Accessory Style: [No Accessories], [Standard Thru-Bolted], [Flanged], [Elite Series], [Anti-Ligature], [Custom]
7. Accessory Finish: [No Accessories], [Standard Satin Stainless], [Matte Black], [Polished Stainless] [White], [Custom]

Optional Accessories†

<input type="checkbox"/> Curtain Rod	<input type="checkbox"/> Shower Drain
<input type="checkbox"/> Shower Curtain	<input type="checkbox"/> 18" grab bar
<input type="checkbox"/> Recessed Soap Dish	<input type="checkbox"/> 24" grab bar
<input type="checkbox"/> Composite Corner Shelf	<input type="checkbox"/> Folding seat
<input type="checkbox"/> Shower Slide-Bar Kit	
<input type="checkbox"/> EverFab Tub-Wrap	

Accessory Style

- Thu-bolted (Standard)
- Flanged
- Elite Series
- Anti-ligature
- Custom, please specify:

Accessory Finish

- Satin Stainless (Standard)
- Matte Black
- Polished Stainless
- White
- Custom, please specify:

†If applicable, please select accessory style and finish from options above. If custom, please also indicate desired location(s) on drawing.