

CLIENT: **EasyTrim Reveals**
 4115 72 Ave SE
 Calgary, Alberta, Canada, T2C 2G5

Test Report No: RJ4491-REV 1 **Original Issue Date: May 3, 2016**
Revised issue Date: May 31, 2016

SAMPLE ID: EasyTrim wall cladding system with Alucoil LARSON ACM 4-mm thick Fire Rated (FR) and 4-mm thick Polyethylene (PE) core panels.

SAMPLING DETAIL: The Alucoil panels were randomly selected by a QAI representative at Alucoil North America located at 1976 Joe Rogers Blvd, Manning, SC 29102 on January 26, 2016. The selected specimens were confirmed to be representative of normally manufactured product at the location of manufacture for Alucoil. The noted test specimen's construction was observed by QAI Laboratories.

DATE OF RECEIPT: Samples were received at QAI Laboratories on February 19, 2016.

TESTING PERIOD: February 23 thru 26, 2016.

AUTHORIZATION: QAI Test Proposal GH-2015-1123-01 R1 signed by Lise Reid, CFO, of EasyTrim Reveals on January 4, 2016.

TEST REQUESTED: ASTM E330-14 *Standard Test Method for Structural Performance of Exterior Windows, Doors, Skylights and Curtain Walls by Uniform Static Air Pressure.*

CONCLUSION: **Average results of LARSON Aluminum Composite Panels Tested with EasyTrim Wall Cladding System.**

ASSEMBLY	AVERAGE ULTIMATE (psf)	AVERAGE ALLOWABLE (psf)	FAILURE COMMENT
4' x 8' 4mm LARSON PE Core	83	42	Core separation from EasyTrim Extrusion, back plate / top cap assembly remained intact.
4' x 8' 4mm LARSON FR Core	85	43	Core separation from EasyTrim Extrusion, back plate / top cap assembly remained intact.

Connection of extrusion to substrate was outside the scope of this testing. Further details can be found in subsequent pages of this report.

Prepared By

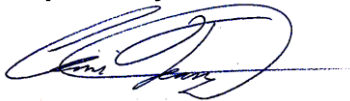

Chris Taylor
 Physical Testing Technician

Signed for and on behalf of QAI Laboratories, Inc.

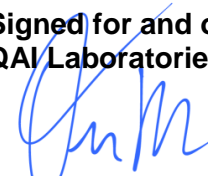

Drew Mersereau
 Laboratory Supervisor

1.0 TEST SET-UP AND PROCEDURE SUMMARY

Testing was conducted in accordance with ASTM E330-14, *Standard Test Method for Structural Performance of Exterior Windows, Doors, Skylights and Curtain Walls by Uniform Static Air Pressure*. Conditions during testing were at 75°F and 50% relative humidity.

The EasyTrim aluminum T5 Grade T6063 aluminum extrusions described below was fastened to an open 4- by 8-ft wood frame constructed of nominal 2 x 4 inch Douglas-fir No.1 lumber that was placed and sealed on top of the perimeter of our steel test chamber shown in Photo 1 in Appendix A of this report. The extrusions were fastened to the wood frame with #8 coarse-thread wood screws of 3-inch length and spaced at 6 inches on center. Note that the wood screws and wood frame may or may not be representative of actual field installation other than to fix the extrusions for the purpose of the testing such that failure of the system will occur other than the extrusion fastening to a member or substrate (in this testing, the member would be the wood frame). We anticipate the limiting design of the system is the ACP panel connection to the extrusions as confirmed by the testing as the mode of failure for the rated allowable uniform load capacity.

Each EasyTrim wall cladding test assembly consisted of the EasyTrim Extrusions QP-90-1 and QP-90-2 (see *diagram 3 and 4 and photograph 4 in Appendix of this report*) which were installed along two boundaries of the wooden frame, The EasyTrim QP-3 Horizontal Extrusion in conjunction with QP-90-1 along one frame boundary (see *diagram 1 and 4 and 3 and photograph 3*) and at the 4th wood frame boundary consisted of the EasyTrim QP-4 and QP-5 Inner and Outer Corner extrusions (see *diagram 2 and 4 and photograph 2*). All extrusions as mentioned were installed to secure the 4' X 8' x 4-mm thick ACP Panels by friction-fit, as representative of the typical field installation. At adjacent friction-fit clamping areas of the EasyTrim Wall Cladding system for connection of multiple ACP Panels, a ¾-inch wide strip of the 4-mm ACP Panel was cut and installed in the EasyTrim Extrusion assemblies (QP-90-1, QP-90-2, QP-4, QP-5 Inner and Outer Corner) to fill the space and represent the adjoining ACP Panel thickness (see *Diagram 4 and photograph 4*).

A 6-mil polyethylene film was draped over the test assembly and sealed to the steel chamber for uniform load application by vacuum pressure applied to the steel chamber. When the vacuum pressure is applied, the 6-mil polyethylene that is applied over the test assembly induces a uniform load over the exterior side of the test assembly to create a positive direction loading, similar to wind loading to the face of a wall panel. For negative load direction, the test assembly was flipped on the other side with the 6-mil polyethylene sheet placed over the interior face of the exterior cladding system under evaluation.

Three dial indicators were located at the mid span of the panel; two were located on both edges and one at mid span in the center of the panel to measure the deflections under incremental load applied. After an initial zero pressure deflection reading was recorded, a test pressure of 5 psf was applied to the test assembly and sustained for a minimum of 10 seconds, after which the deflection at the dial gauges was recorded. The load was then released and allowed a recovery period between 1 minute and 5 minutes for the panel to stabilize. After the recovery period, the pressure was increased by 5 psf over the last increment, where the load was sustained for a minimum of 10 seconds following which the deflection was taken and the pressure released. The loading procedure was repeated until ultimate load was achieved in the test assembly. At failure, the mode of failure was recorded. The deflection-load charts are provided on the subsequent pages of this report using only the mid-span center of panel deflections.

A single test assembly was loaded in the positive pressure direction, followed by testing of another single assembly in the negative pressure direction to determine the weaker direction of the panel assembly. Once determined, two additional cladding assemblies were tested in the weaker load direction to fulfill the three replicate sample set. Photographs and diagrams of the test set up is provided in Appendix A of this report.

2.0 TEST SPECIMEN DESCRIPTION

2.1 Test Assembly 1 (4' x 8' 4-mm PE ACP Panel Test Assembly):

Four 4- by 8-ft test assemblies were constructed using the 4-mm PE Alucoil LARSON ACP panels with EasyTrim aluminum extrusions fastened to wood frames. The panels were friction-fit into the extrusions as described in Section 1 of this report.

2.2 Assembly 2 (4' x 8' 4mm FR ACP Panel Test Assembly):

Four 4- by 8-ft test assemblies were constructed using the 4-mm FR Alucoil LARSON ACP panels with EasyTrim aluminum extrusion fastened to wood frames. The panels were friction-fit into the extrusions as described in Section 1 of this report.

3.0 TEST RESULTS AND FINDINGS

Results of testing are summarized in the following subsequent sections.

3.1 Assembly 1:

Results of the assemblies with the Alucoil LARSON 4-mm PE ACP panel with EasyTrim aluminum are summarized in Table 1 below. Load-deflection curves are included below Table 1.

Table 1- Results of Test Assembly 1 (with angle restraint at remaining edge)

Test Assembly & Test No.	Load Direction	Load L/60 Midspan (psf)	Ultimate Load (psf)	Allowable Load ⁽¹⁾ (psf)	Comments/Mode of Failure
Assembly 1-Test 1	Positive	Not Applicable	N/A	N/A	Assembly deflection limiter restricted further deflection of panel, failure of system could not be achieved.
Assembly 1-Test 2 ⁽²⁾	Negative	18	76	38	PE core panel pulled out of back plate / top cap trim assembly at one side of the panel. Back plate / top cap trim assembly remained intact. See photograph #5
Assembly 1-Test 3	Negative	18	97	49	PE core panel pulled out of back plate / top cap trim assembly at one side of the panel. Back plate / top cap trim assembly remained intact. See photograph #5
Assembly 1-Test 4	Negative	19	77	39	PE core panel pulled out of back plate / top cap trim assembly at one side of the panel. Back plate / top cap trim assembly remained intact. See photograph #5
Average		18	83	42	
Standard Deviation		1	12	6	
Coefficient of Variation		3%	14%	14%	

Table 1 Footnotes:

- (1) Allowable load determined as ultimate load with an applied factor of safety of 2.
- (2) Failure mode was not achieved in positive direction and load was higher than negative direction; thus, two additional panels were tested in the negative direction.

Assembly 1-Test 1 Load-Deflection Graph: 4' x 8' 4mm LARSON PE ACP with EASYTRIM ALUMINUM EXTRUSION in Positive Load Direction

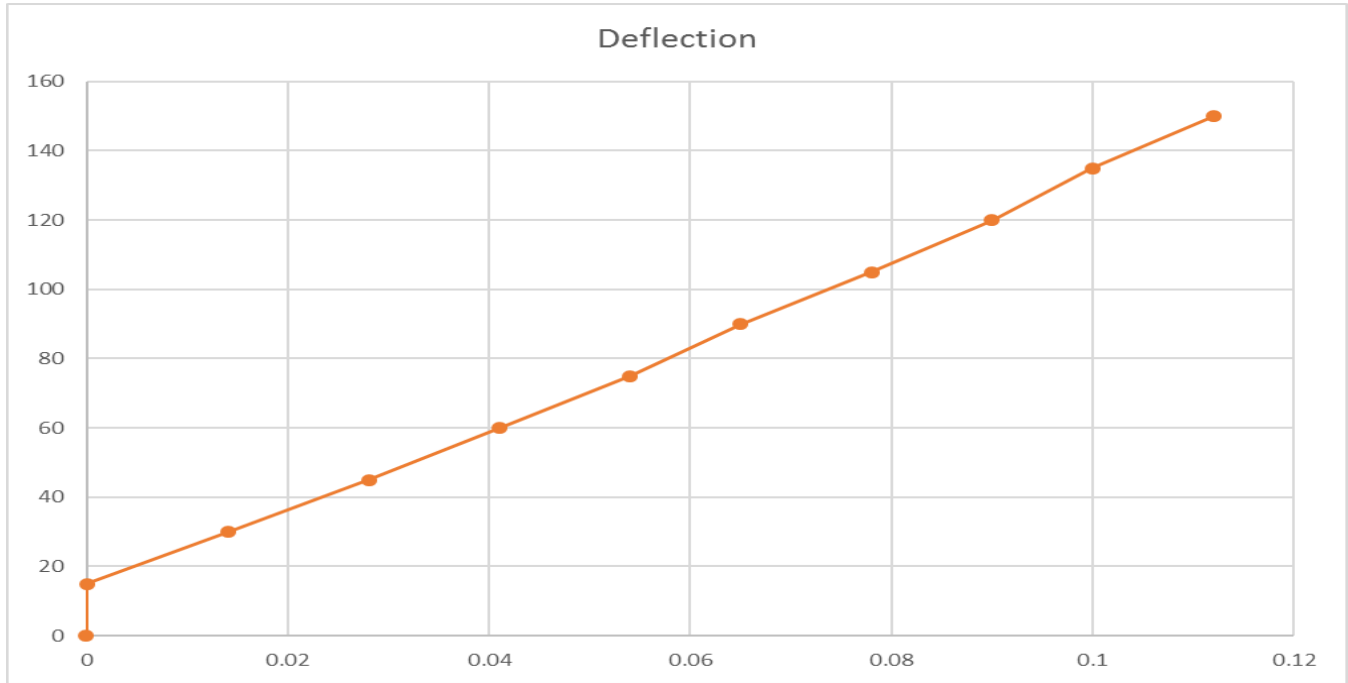

Assembly 1-Test Nos. 2 through 4 Load-Deflection Graph: 4' x 8' 4mm LARSON PE ACP with EASYTRIM ALUMINUM EXTRUSION in Negative Load Direction

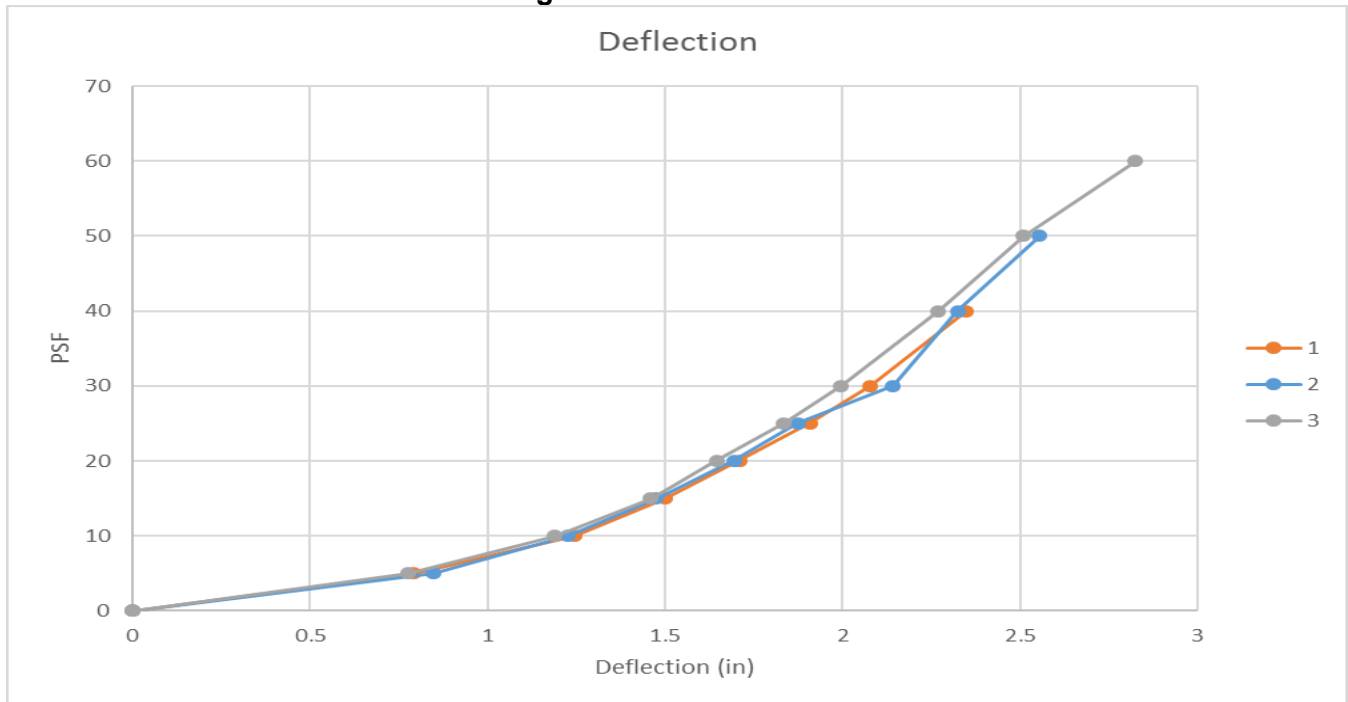

3.2 Assembly 2:

Results of the assemblies with the Alucoil LARSON 4-mm FR Core ACP panel with EasyTrim aluminum are summarized in Table 2 below. Load-deflection curves are included below Table 2.

Table 2- Results of Test Assembly 2

Test Assembly & Test No.	Load Direction	Load L/60 Midspan (psf)	Ultimate Load (psf)	Allowable Load ¹ (psf)	Mode of Failure
Assembly 2-Test 1	Positive	Not Applicable	N/A	N/A	Assembly deflection limiter restricted further deflection of panel, failure of system could not be achieved.
Assembly 2-Test 2 ²	Negative	21	85	43	FR core panel pulled out of back plate / top cap trim assembly at one side of the panel. Back plate / top cap trim assembly remained intact. See photograph #5
Assembly 2-Test 3	Negative	20	85	43	FR core panel pulled out of back plate / top cap trim assembly at one side of the panel. Back plate / top cap trim assembly remained intact. See photograph #5
Assembly 2-Test 4	Negative	20	91	46	FR core panel pulled out of back plate / top cap trim assembly at one side of the panel. Back plate / top cap trim assembly remained intact. See photograph #5
Average		20	85	43	
Standard Deviation		1	3	2	
Coefficient of Variation		3%	4%	2%	

Table 2 Footnotes:

- (1) Allowable load determined as ultimate load with an applied factor of safety of 2
- (2) Failure mode was not achieved in positive direction and load was higher than negative direction; thus, two additional panels were tested in the negative direction.

Assembly 2-Test 1 Load-Deflection Graph: 4' x 8' 4mm LARSON FR ACP with EASYTRIM ALUMINUM EXTRUSION in Positive Load Direction

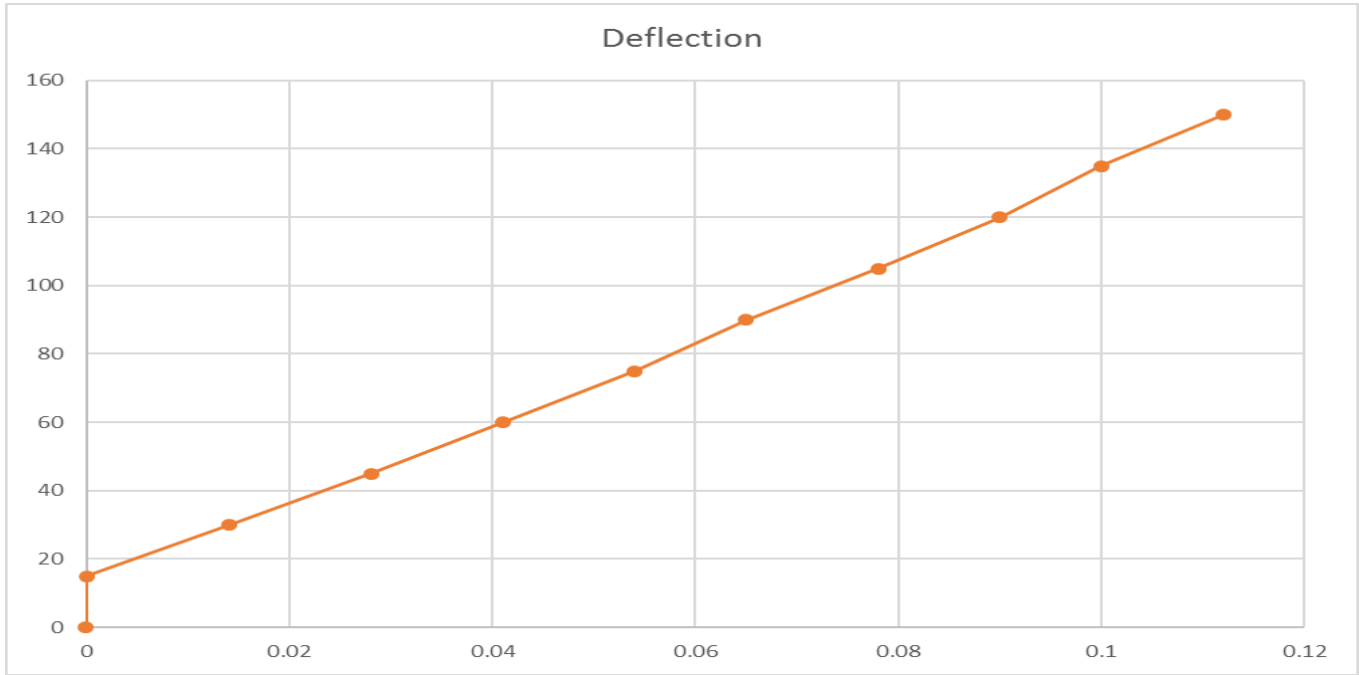

Assembly 2-Test No. 2 through 4 Load-Deflection Graph: 4' x 8' 4mm LARSON FR ACP with EASYTRIM ALUMINUM EXTRUSION in Negative Load Direction

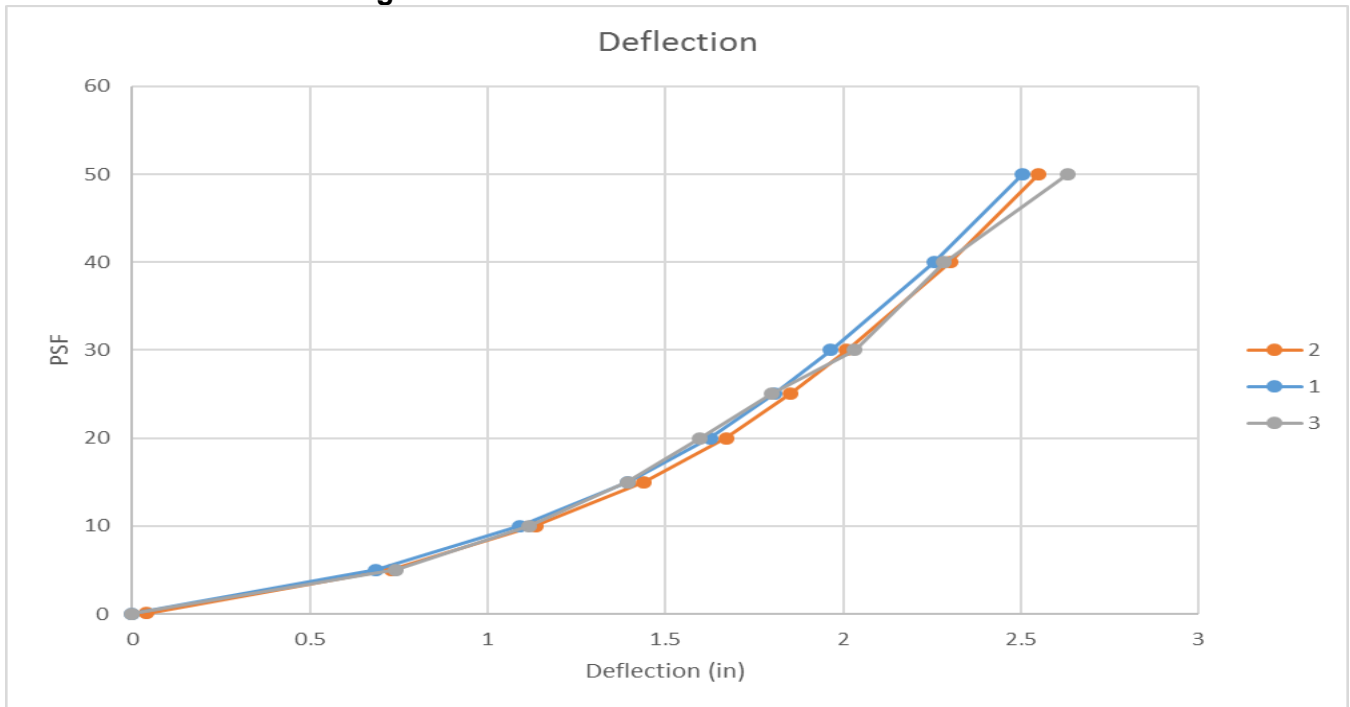

THIS REPORT IS THE CONFIDENTIAL PROPERTY OF THE CLIENT ADDRESSED. THE REPORT MAY ONLY BE REPRODUCED IN FULL. PUBLICATION OF EXTRACTS FROM THIS REPORT IS NOT PERMITTED WITHOUT WRITTEN APPROVAL FROM QAI. ANY LIABILITY ATTACHED THERETO IS LIMITED TO THE FEE CHARGED FOR THE INDIVIDUAL PROJECT FILE REFERENCED. THE RESULTS OF THIS REPORT PERTAIN ONLY TO THE SPECIFIC SAMPLE(S) EVALUATED.

APPENDIX A
Photographs



Photograph No.1
Negative Uniform Load Test Set-up

APPENDIX Continued



Photograph No.2

Test Frame with The EasyTrim Extrusion Assembly installed after ACP Test Panel was removed after test.

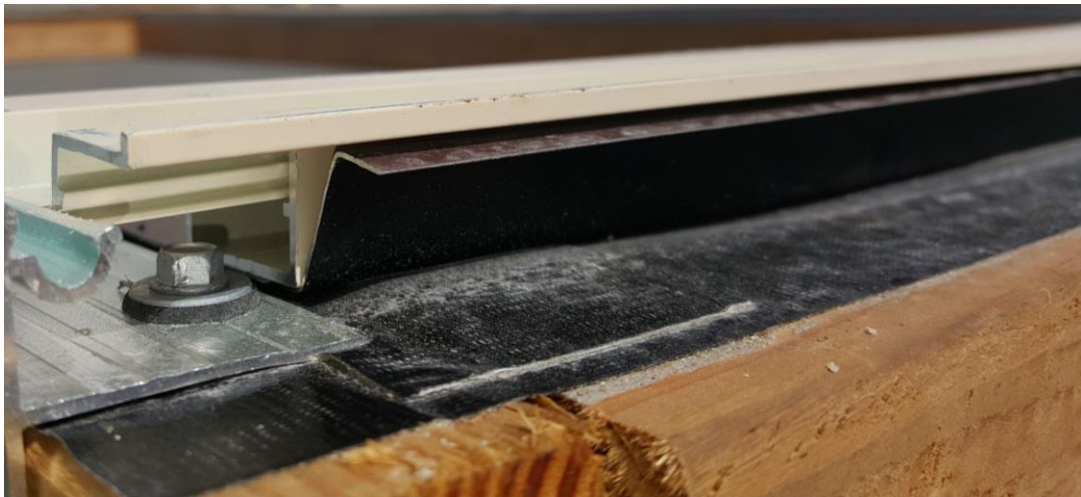

Photograph No.3

QP-3 Horizontal Extrusion Profile Used with QP-90-1, Used to Simulate Horizontal Termination of Assembly (1 Edge of Assembly), After test.

APPENDIX Continued

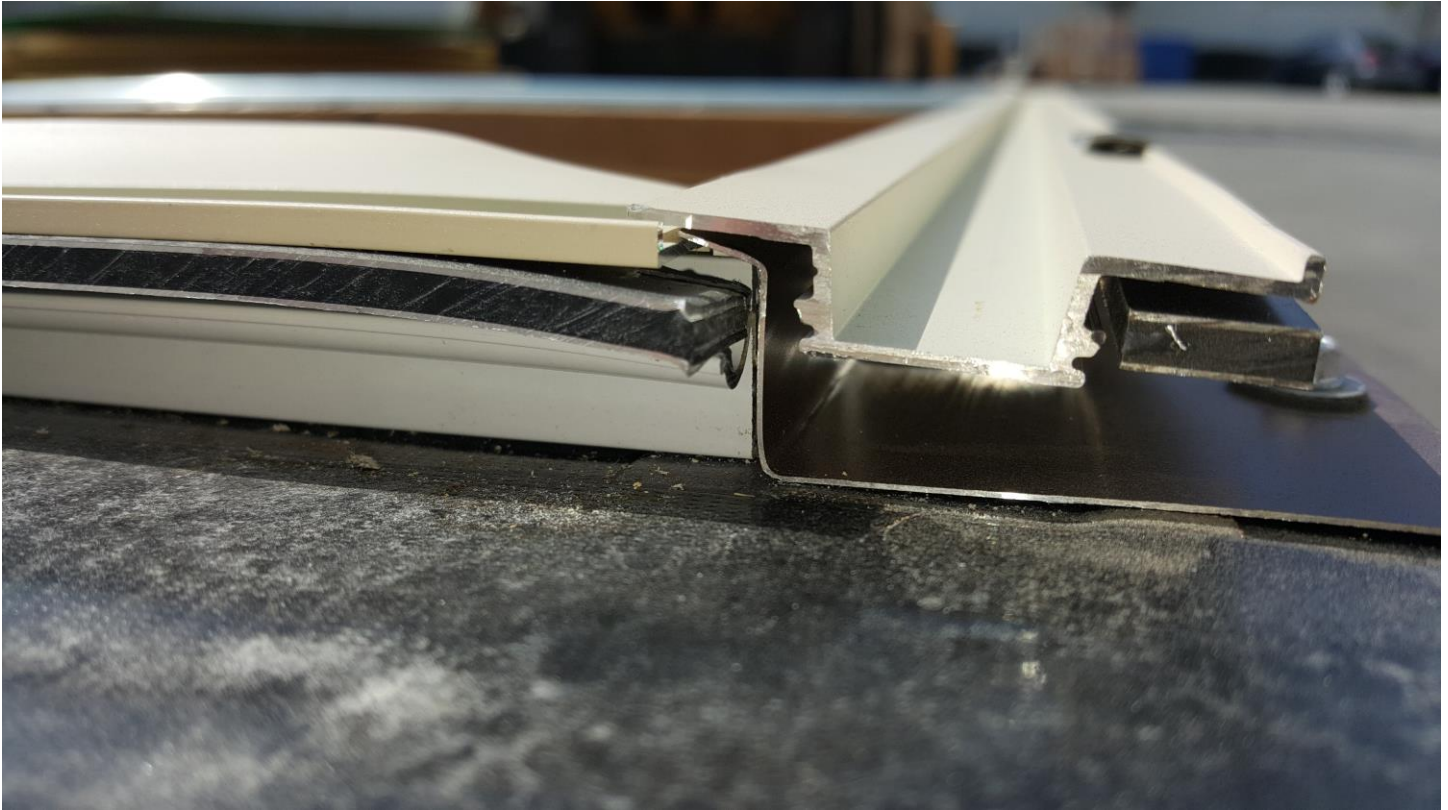

Photograph No.4

EasyTrim Extrusions QP-90-1 and QP-90-2 used along 2 edges of the Test Frame with 3/4" Wide Strip of ACP Panel installed on Adjacent Edge to simulate Typical Field Installation after Test.

APPENDIX Continued



Photograph No.5

Typical results of negative load tests Panel separated from back plate / top cap trim assembly at one side of the panel. Back plate / top cap trim assembly remained intact.

APPENDIX Continued



Photograph No.6
Positive Uniform Load Test Set-up

APPENDIX B
Diagrams

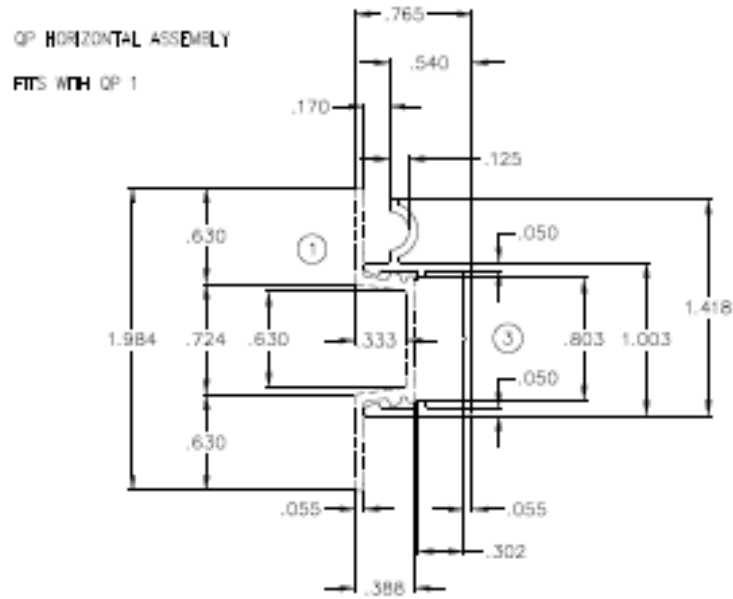

Diagram No.1
QP-3 Horizontal Extrusion Profile Used for Horizontal End Installations

APPENDIX Continued

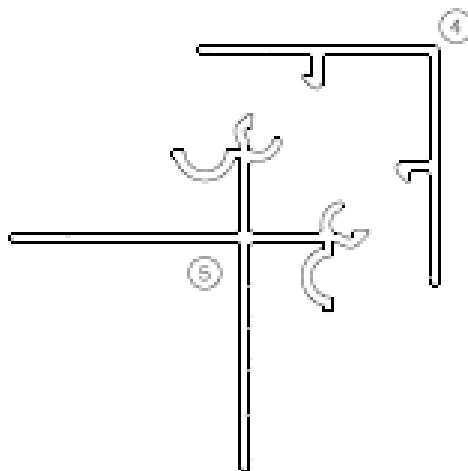
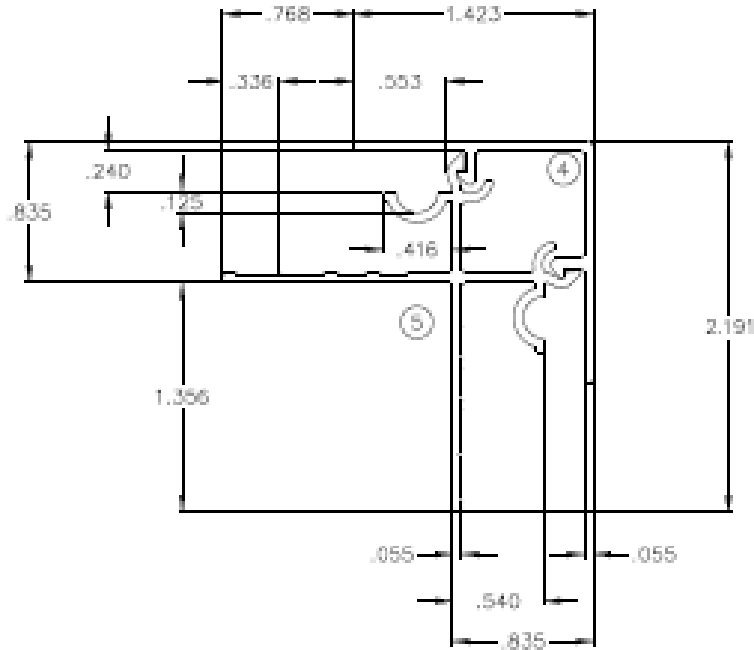

Diagram No.2

QP-4 and QP-5 Inner and Outer Corner Assembly Extrusion Profile Used in Test Assembly

APPENDIX Continued

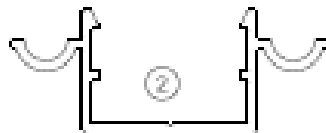
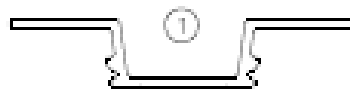
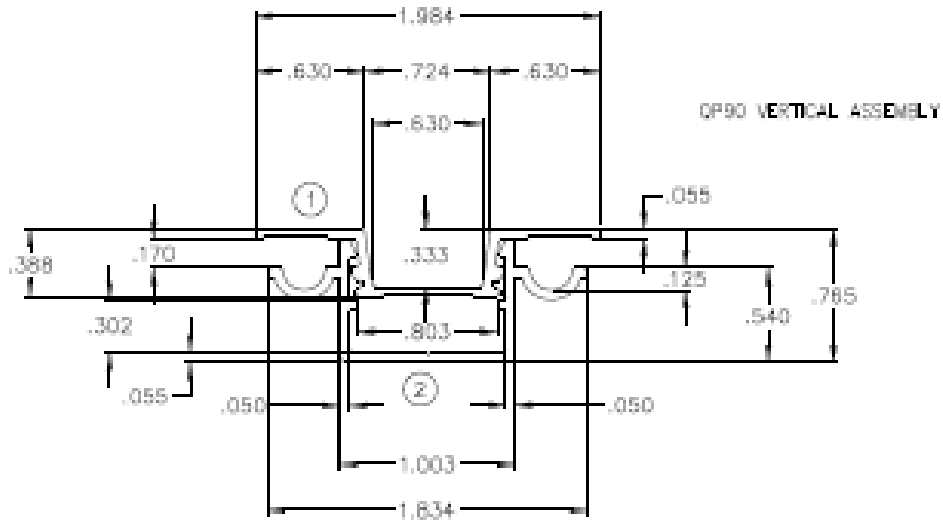

Diagram No.3
 QP-90-1 and QP-90-2 Assembly Extrusion Profile Used in Test Assembly

APPENDIX Continued

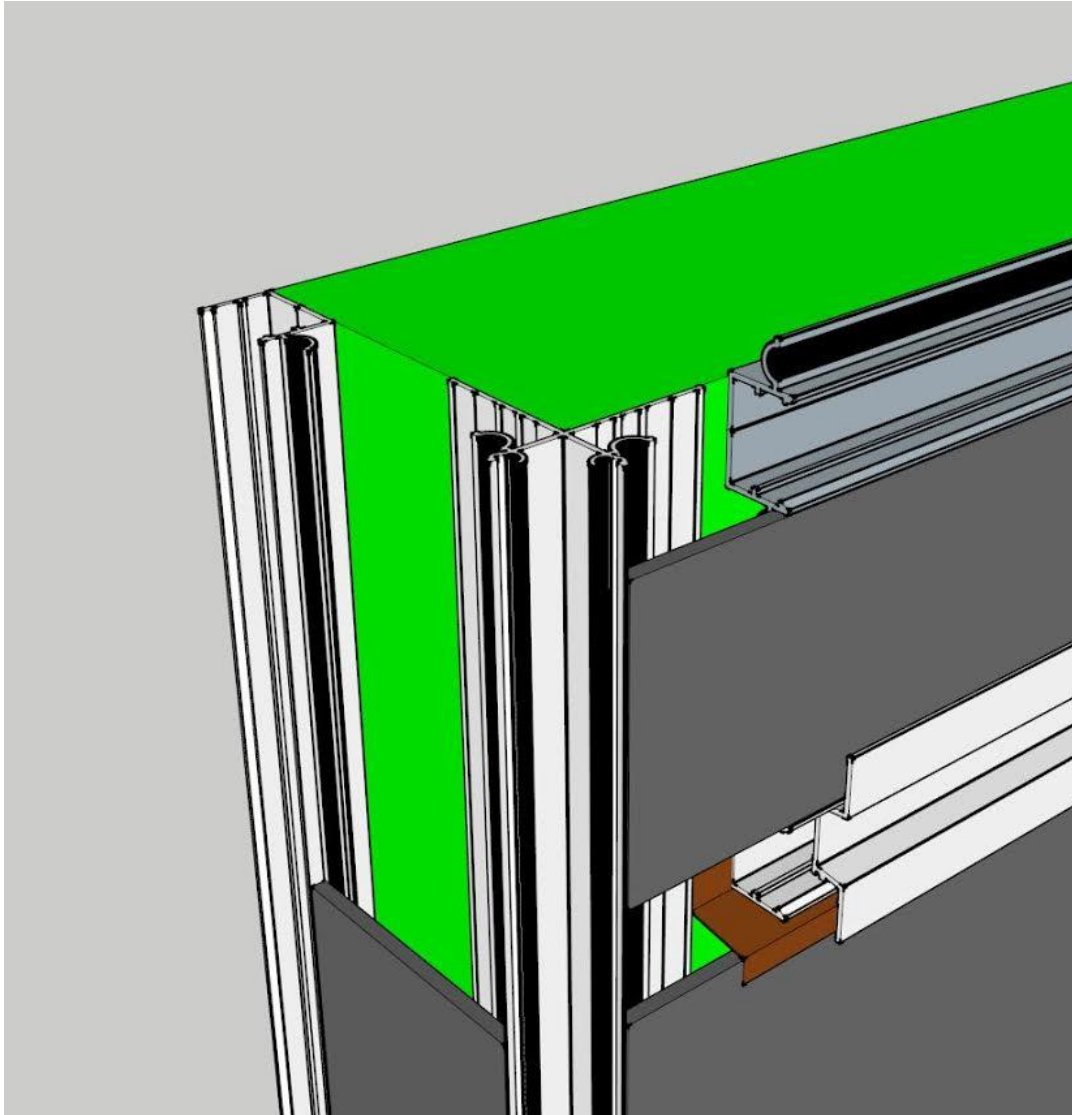

Diagram No.4
Assembly Drawing of All Components used in a typical Field Installation

Revision History

1. On May 31, 2016, Typographical Errors were corrected in the Test results charts title on pages 1,4, and 6 of this report.
2. All references of "Alucoil LARCORE ACM..." were changed to " Alucoil LARSON ACM.." throughout all of this report
3. Formatting issues were corrected on page 1 of this report.

This report replaces and supersedes any report previously issued under the RJ4491 Naming Series.

*****<<<End of Report>>>*****