



Kyoto Electronics

Electrodes for Potentiometric Titrator



KYOTO ELECTRONICS

Potentiometric titration is a method to detect potential difference between the indicator electrode and reference electrode and thus determine concentration of chemical component, which reacts with reagent added to a solution potentially in equilibrium at the beginning.

The popularly used reference electrode is either silver-silver chloride or mercury sulfate electrode, and the indicator electrode is generally made of glass electrode, platinum electrode and silver electrode or ion selective electrode.

It is necessary to select an appropriate electrode both indicator and reference depending on chemically reacting components in various titration types like acid-base titration, precipitation titration, redox titration or chelate titration.

There is a combination electrode combining two electrodes into one, which works as both indicator and reference electrode.

Item		Preamplifier	Electrode	
Type of titration	Example of titration		Indicator electrode	Reference electrode
Acid-base titration	Acid-Base HCl-NaOH H ₂ SO ₄ -NaOH Benzoic acid-KOH HCl-Na ₂ CO ₃ HClO ₄ -C ₆ H ₄ (COOK)(COOH)	STD-510 (Standard) TET-510 PTA-510 POT-510 CMT-510	Glass electrode Example : H-171 : C-172 (Combination)	Ceramic type Example : R-171 Sleeve type Example : R-172
Precipitation titration	AgNO ₃ -I ⁻ AgNO ₃ -Br ⁻ AgNO ₃ -Cl ⁻ AgNO ₃ -CN ⁻ AgNO ₃ -SCN ⁻ PB(ClO) ₂ -SO ₄ ²⁻		Silver electrode Example : M-371 : M-214 : C-373 (Combination)	HgSO ₄ -Sleeve type Example : R-272 Double junction-sleeve type Example : R-173
Redox titration	Na ₂ S ₂ O ₃ -I ₂ KMnO ₄ -Fe ²⁺		Platinum electrode Example : M-271 : C-272 (Combination)	Ceramic type Example : R-171 Sleeve type Example : R-172
Oil and petroleum product neutralization number titration	Acid number of fat and oil Neutralization number of fatty acid Acid number of petroleum products Base number of petroleum products		Glass electrode Example : H-171 : C-172 (Combination)	Sleeve type Example : R-172 Double junction-sleeve type Example : R-173 Cork type Example : R-115
Chelate titration by ion selective electrodes	EDTA-Ca ²⁺ , Mg ²⁺ EDTA-Zn ²⁺		Reference : Ion Selective Electrode	
Measurement of surfactants	Anion Kation		Surfactant electrode S-171 (Combination)	
Chelate titration by photometric method	EDTA-Ca ²⁺ , Mg ²⁺ EDTA-Zn ²⁺ EDTA-Ni ²⁺		PTA-510	Photometric sensor P-114 (Standard accessory of PTA-510)
Bromine number titration	KBrO ₃ -Olefin group	POT-510	Twin platinum electrode Example : M-511, : M-512	
Diazotization titration	NaNO ₂ -Aromatic primary amine			
Conductometric titration	AgNO ₃ -I ⁻ AgNO ₃ -Br ⁻ AgNO ₃ -Cl ⁻ NaOH-HCl	CMT-510	Conductometric sensor K-321 (Standard accessory of CMT-510)	

1. Glass electrode · Combined glass electrode

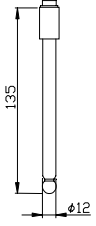
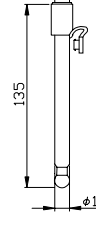
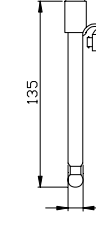
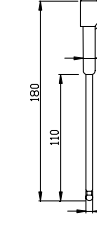
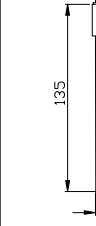
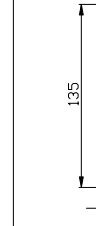
	Glass electrode	Combined glass electrode	Combined glass electrode	Micro-combined glass electrode	Epoxy type combined glass electrode	Combined glass electrode
Type	H-171	C-172	C-173	C-675	C-181	C-472
Application	For acid-base titration	For acid-base titration	For non-aqueous titration	For acid-base titration	For acid-base titration	For high-alkaline titration
Dimension						
pH range	pH0-13	pH0-13	pH0-13	pH0-12	pH0-12	pH0-14
Temperature	0°C~100°C	0°C~100°C	0°C~100°C	0°C~100°C	0°C~100°C	5°C~100°C
Inner electrode	Ag-AgCl	Ag-AgCl	Ag-AgCl	Ag-AgCl	Ag-AgCl	Ag-AgCl
Liquid junction	—	Sleeve	Double junction	Sleeve	Ceramic	Sleeve
Inner filling	—	3.3M KCl	Inner cell : 3.3M KCl *1 Outer cell : 3.3M KCl *2	3.3M KCl	3.3M KCl *1	3.3M KCl
Cable	Detachable	Detachable	Detachable	Detachable	Detachable	Detachable
	H-174 is 180 mm length	C-175 is 180. C-192 comes with side-arm	C-176 is 180 mm length *3	C-678 is 220 mm length		

2. Combined metal electrode

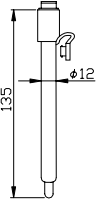
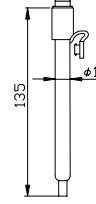
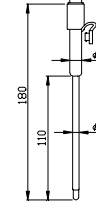
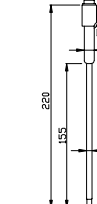
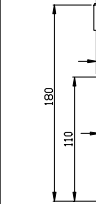
	Combined platinum electrode	Combined silver electrode	Micro-combined platinum electrode	Micro-combined platinum electrode	Micro-combined silver electrode
Type	C-272	C-373	C-775	C-578	C-875
Application	For redox titration	For precipitation titration	For redox titration	For COD measurement	For precipitation titration
Dimension					
pH range	0°C~100°C	0°C~100°C	0°C~100°C	0°C~100°C	0°C~100°C
Temperature	Platinum	Silver	Platinum	Platinum	Silver
Inner electrode	Ag-AgCl	Ag-AgCl	Ag-AgCl	HgSO ₄	Ag-AgCl
Liquid junction	Sleeve	Double junction	Sleeve	Sleeve	Sleeve
Inner filling	3.3M KCl	Inner cell : 3.3M KCl *1 Outer cell : 1M KNO ₃	3.3M KCl	K ₂ SO ₄ saturated solution	1M KNO ₃
Cable	Detachable	Detachable	Detachable	Detachable	Detachable
			C-778 is 220 mm length	C-598 comes with side-arm	C-878 is 220. C-898 comes with side-arm

*1 : The inner filling is sealed type, no need to re-fill or renewed.

*2 : The inner filling of outer cell of double junction reference electrode must be selected appropriate to the application.

*3 : The electrode C-173, C-176, R-173 and R-176 can be used both in acid-base and precipitation titration if the outer cell is filled with 1M KNO₃.

3. Reference electrode

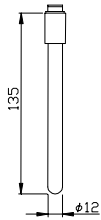
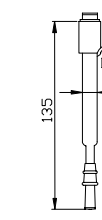
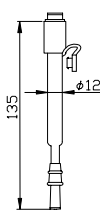
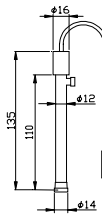
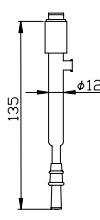
	Reference electrode	Reference electrode	Reference electrode	Cork type Reference electrode	HgSO ₄ Reference electrode
Type	R-171	R-172	R-173	R-115	R-272
Application	For acid-base and redox titration	For acid-base and non-aqueous titration	For non-aqueous titration	For non-aqueous titration	For precipitation titration
Dimension					
Temperature	0°C~100°C	0°C~100°C	0°C~100°C	-5°C~80°C	0°C~100°C
Inner electrode	Ag-AgCl	Ag-AgCl	Ag-AgCl	Ag-AgCl	HgSO ₄
Liquid junction	Ceramic	Sleeve	Double junction	Cork	Sleeve
Inner filling	3.3M KCl	3.3M KCl	Inner cell : 3.3M KCl*1 Outer cell : 3.3M KCl*2	3.3M KCl	K ₂ SO ₄ saturated solution
Cable	Detachable	Detachable	Detachable	Detachable	Detachable
	R-174 is 180 mm length	R-175 is 180 mm length	R-176 is 180 mm length*3	R-118 is 180 mm length	

Features and Applications of Reference electrode

Reference electrodes can be classified according to liquid junction type (where inner filling and measured solution make contact) as follows:

1. Ceramic type

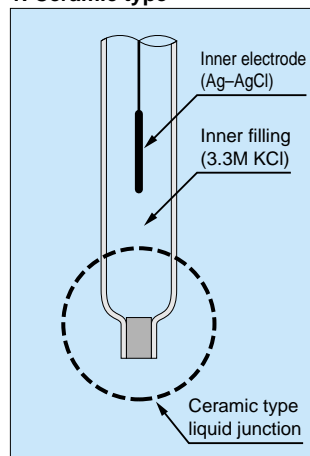

Since the inner filling flows out very little, this type of electrode is generally adequate for acid-base or redox titration of a aqueous solution. In non-aqueous titration, potential may turn out to be unstable. Therefore, it is necessary to check on potential stability.

2. Sleeve type

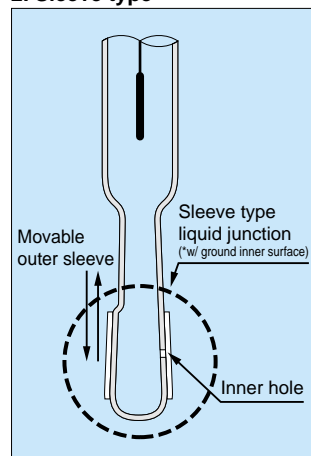

Since the liquid junction is easy to clean with minimal liquid potential in liquid junction, this type of electrodes can be applied to a wide range of titration. However, potential may be unstable when sliding area in junction turns out sticky or loosened. Therefore, it is necessary to check and clean from time to time. Also, the inner filling flows out relatively fast, and it is important to refill inner filling.

3. Double junction type

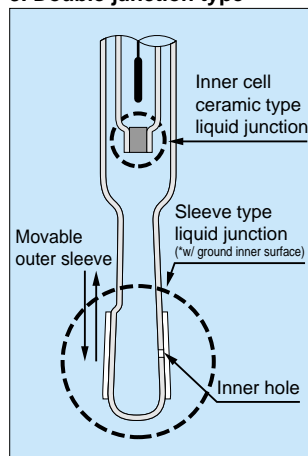

The inner filling (3.33M-KCl) tends to be less contaminated, however, for outer cell use liquid other than KCl that would not react with titration solution. For example, in silver nitrate titration for chlorine ion, use 1M-potassium nitrate instead of KCl for outer cell. For non-aqueous titration, use such inner filling as Lithium chloride for the outer cell with higher solubility to titrants.

4. Cork type

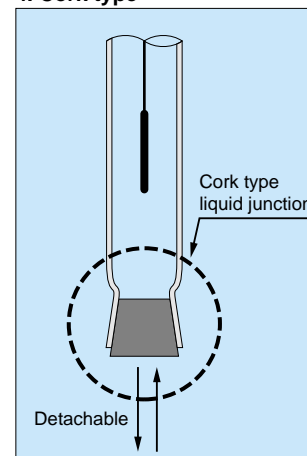

This type of electrode is used for non-aqueous titration where liquid junction is apt to generate unstable potential or when measuring samples such as paints liable to fouling liquid junction. Accordingly, the cork of the liquid junction must be periodically replaced with new one.

4.Metal electrode

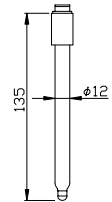
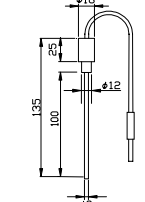
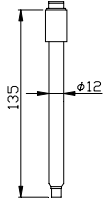
	Platinum electrode	Silver electrode	Silver electrode
Type	M-271	M-214	M-371
Application	For redox titration	For precipitation micro-titration	For precipitation titration
Dimension			
Temperature	0°C~100°C	-5°C~100°C	0°C~100°C
Detection metal	Platinum	Silver	Silver
Cable	Detachable	70 cm length	Detachable
	M-274 is 180 mm length		

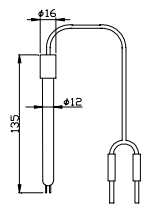
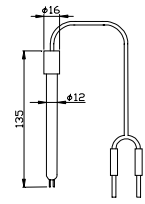
	Twin platinum electrode	Twin platinum electrode
Type	M-511	M-512
Application	For polarization titration	For polarization titration
Dimension		
Temperature	-5°C~80°C	-5°C~80°C
Detection metal	Platinum	Platinum (plate)
Cable	70 cm length	70 cm length
	M-513 is 180 mm length	

5.Temperature compensation electrode

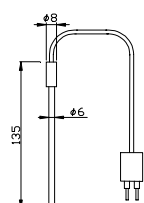
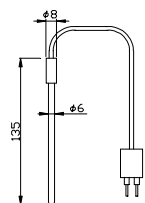
	Temperature compensation electrode	Temperature compensation electrode
Type	T-111	T-111L
Application	For pH Temp. Comp.	For pH Temp. Comp.
Dimension		
Temperature	-5°C~100°C	-5°C~100°C
Detection metal	Thermistor	Thermistor
Cable	70 cm length	200 cm length
	T-112 is 180 mm length	

6.Ion selective electrode

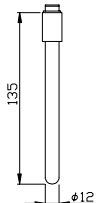
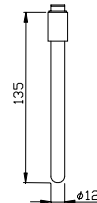
	Calcium ion electrode	Chloride ion electrode
Type	I-171	I-271
Dimension		
pH range	pH 3.5~11	pH 2~12
Measuring range (mol)	0.1~5 × 10 ⁻⁷ M	1.0~5 × 10 ⁻⁵ M
Temperature	0~50°C	0~80°C
Cable	Detachable	Detachable

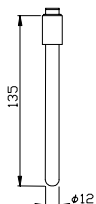
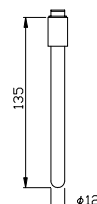
	Copper ion electrode	Lead ion electrode
Type	I-371	I-471
Dimension		
pH range	pH 2~12	pH 3~8
Measuring range (mol)	0.1~1 × 10 ⁻⁸ M	0.1~1 × 10 ⁻⁶ M
Temperature	0~80°C	0~80°C
Cable	Detachable	Detachable

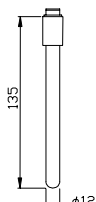
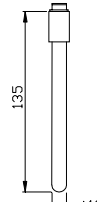
	Fluoride ion electrode	Iodide ion electrode
Type	I-571	I-671
Dimension		
pH range	pH 2.5~11	pH 0~14
Measuring range (mol)	1.0~7 × 10 ⁻⁶ M	0.1~5 × 10 ⁻⁸ M
Temperature	0°C~80°C	0°C~80°C
Cable	Detachable	Detachable

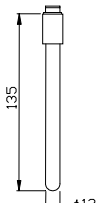
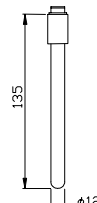
	Sodium ion electrode	Cadmium ion electrode
Type	I-771	I-871
Dimension		
pH range	pH 5~12	pH 2~8
Measuring range (mol)	Saturate~1 × 10 ⁻⁶ M	0.1~5 × 10 ⁻⁸ M
Temperature	0°C~80°C	0°C~80°C
Cable	Detachable	Detachable

Reference electrode:

- R-171 (Inner filling : 3.3M KCl)= For I-171 or I-571
- R-173 (Inner filling : 1M KNO₃)= For I-271, I-371, I-471, I-671 or I-871
- R-173 (Inner filling : Saturated (NH₄)₂SO₄)= For I-771



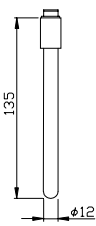



7.Surfactant electrode

	Surfactant electrode
Type	S-171
Dimension	
pH range	2-12
Measuring range (mol)	0.01~1×10 ⁻⁸ M
Temperature	0-50°C
Cable	Detachable

Accessories:

0.05M Benzethonium chloride 30 mL,
0.01M Sodium dodecyl sulfate 30 mL,
1% Triton-X 30 mL,
3.33M KCl 30 mL

8. Connecting cable for detachable type

Part No.	#429-0012	#429-0013	#429-0014	#429-0015	#429-0016	#429-0017
Type of connector	BNC	US standard	Pin type	BNC	US standard	Pin type
Appearance						
Connectable titrators	AT-510, AT-500, AT-420	AT-410, AT-400, AT-310, AT-210	All KEM's titrators	AT-510, AT-500, AT-420	AT-410, AT-400, AT-310, AT-210	All KEM's titrators
Cable length	90 cm	90 cm	90 cm	210 cm	210 cm	210 cm

9. Maintenance filling, etc.**9-1.Inner filling**

Name	3.3M KCl	Saturated K ₂ SO ₄	1M KNO ₃
Part No.	#811-5001	#811-5012	#811-0026
Applications	For inner filling of reference or combination electrode where silver chloride is used for the inner cell.	For inner filling of reference or combination electrode where mercury sulfate is used for the inner cell.	For inner filling of combination silver electrodes.
Volume	250 mL	250 mL	250 mL

Note: Use inner filling for outer cell of a double junction reference electrode appropriate for the application.

9-2.Another parts

Name	Polishing paper	Dispersant for argentometric titration
Part No.	#599-0006	#810-0023
Applications	Used for polishing detecting unit of platinum electrode, silver electrode and the like.	Used for preventing deposits from being built up on the electrode in argentometric titration.
number	24 pieces	25 g

Detachable type electrode

Part No.	Name	Liquid junction	Length of electrode (mm)	Diameter of electrode (mm)	Usable cable			Electrode of old type
					#429-0012 #429-0015	#429-0013 #429-0016	#429-0014 #429-0017	
#100-H171	Glass El.	—	135	12	○	○	×	H-112/H-152
#100-H174	Glass El.	—	180	12	○	○	×	H-113/H-153
#100-R171	Reference El.	Ceramic	135	12	×	×	○	R-116
#100-R172	Reference El.	Sleeve	135	12	×	×	○	R-112
#100-R173	Reference El.	Double junction	135	12	×	×	○	R-114
#100-R174	Reference El.	Ceramic	180	12	×	×	○	R-117
#100-R175	Reference El.	Sleeve	180	12	×	×	○	R-120
#100-R176	Reference El.	Double junction	180	12	×	×	○	R-119
#100-R272	HgSO ₄ reference El.	Sleeve	135	12	×	×	○	R-212
#100-C172	Combined glass El.	Sleeve	135	12	○	○	×	C-159
#100-C192	Combined glass El. (with side arm)	Sleeve	135	12	○	○	×	C-159
#100-C472	Combined glass El. (For high alkaline)	Sleeve	135	12	○	○	×	non
#100-C173	Combined glass El.	Double junction	135	12	○	○	×	non
#100-C175	Combined glass El.	Sleeve	180	12	○	○	×	C-117/C-157
#100-C176	Combined glass El.	Double junction	180	12	○	○	×	non
#100-C181	Epoxy resin type Combined glass El.	Ceramic	135	12	○	○	×	non
#100-C675	Micro combined glass El.	Sleeve	180	6	○	○	×	C-114/C-154
#100-C678	Micro combined glass El.	Sleeve	220	6	○	○	×	C-112/C-152
#100-C272	Combined platinum El.	Sleeve	135	12	○	○	○	non
#100-C775	Micro combined platinum El.	Sleeve	180	6	○	○	○	C-214/C-254
#100-C778	Micro combined platinum El.	Sleeve	220	6	○	○	○	C-213/C-253
#100-C578	Micro combined platinum El. (For COD)	Sleeve	220	6	○	○	○	C-501/C-511
#100-C598	Micro combined platinum El. (For COD, with side arm)	Sleeve	220	6	○	○	○	C-501/C-511
#100-C373	Combined silver El.	Double junction	135	12	○	○	○	non
#100-C875	Micro-combined silver El.	Sleeve	180	6	○	○	○	non
#100-C878	Micro-combined silver El.	Sleeve	220	6	○	○	○	non
#100-C898	Micro-combined silver El. (with side arm)	Sleeve	220	6	○	○	○	non
#100-M271	Platinum El.	—	135	12	○	○	○	M-111
#100-M274	Platinum El.	—	180	12	○	○	○	M-113
#100-M371	Silver El.	—	135	12	○	○	○	M-211/M-214
#100-I171	Calcium ion selective El.	—	135	12	○	○	×	non
#100-I271	Chloride ion selective El.	—	135	12	○	○	×	non
#100-I371	Copper ion selective El.	—	135	12	○	○	×	non
#100-I471	Lead ion selective El.	—	135	12	○	○	×	non
#100-I571	Fluoride ion selective El.	—	135	12	○	○	×	non
#100-I671	Iodide ion selective El.	—	135	12	○	○	×	non
#100-I771	Sodium ion selective El.	—	135	12	○	○	×	non
#100-I871	Cadmium ion selective El.	—	135	12	○	○	×	non

Note: El. is electrode.

Automatic Potentiometric Titrator **AT-510**

The AT-510 titrator can perform potentiometric titration including acid-base, redox, precipitation, chelatometric and non-aqueous titration. With optional peripherals, it also can perform photometric, polarization, conductometric and surfactant titration. When the CHA-500 multiple sample changer is connected, it can automatic measurements of a number of samples unattended and save both time and man-power with reliable results and simpler operations, thus applicable to lots of fields where quality and inspection control, analytical works and R&D activities are demanded and conducted.

- Utilizes oversized LCD allows clear display of information such as Titration curve and Messages.
- Judgment reinforce function for end-point detection.
- Anti-diffusion structure on titration nozzle of burette.
- Safety cover to protect burette cylinder.
- GLP/GMP conformed.
- Safety and EMC features conforming to CE marking declaration.
- Data store/retrieve with PC cards.
- KF(volumetric) moisture titration unit as an option.
- COD titration unit as an option.
- Printing on A4-size paper (option).



Automatic Potentiometric Titrator **AT-500N**

- High performance at low price.
- Easy-to-read display with backlighting.
- Anti-diffusion structure on titration nozzle of burette.
- Safety cover to protect burette cylinder.
- GLP/GMP conformed.
- Safety and EMC features conforming to CE marking declaration.
- AT-500N-1 comes with single burette.
- AT-500N-2 comes with twin burettes.



**KYOTO ELECTRONICS
MANUFACTURING CO.,LTD.**

Overseas Division : 8-3 Niban-cho Chiyoda-ku TOKYO 102-0084,
JAPAN Fax : +81-3-3237-0537, Phone : +81-3-3239-7333

URL : <http://www.kyoto-kem.com>

Distributed by

scientific*gear

1984 Isaac Newton Sq.
Reston VA 20190
(800) 998-6429

Specifications and design subject to change for improvements without notice. printed in Japan.

29IK33A