



User and programming manual for Vista's Quantum Evolution range of DVR.

Including:

- QUANTUM04-XXEVs
- QUANTUM04DVDXXXEVs
- QUANTUM08DVDXXXEVs
- QUANTUM16DVDXXXEVs



This page is intentionally left blank

## CE INFORMATION

The product must be installed according to the currently valid installation regulations for EMC to guarantee the designed use and to prevent EMC problems.

The device supplied with this manual is according to the EC, EMC Directive, 89/336/EEC & LVD 73/23/EEC

Standard used for showing compliance with the essential requirements of the device:

EN 55022

EN 61000-3-2

EN 61000-3-3

EN 50130-4

EN 55024

LVD: EN60950-1

## ELECTRICAL SAFETY

Explanation of electrical safety symbols

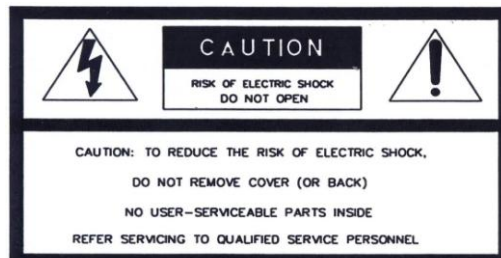

The lightning flash with arrowhead symbol, within an equilateral triangle, is intended to alert the user to the presence of uninsulated "dangerous voltage" within the product's enclosure that may be of sufficient magnitude to constitute a risk of electric shock to persons.



The exclamation point within an equilateral triangle is intended to alert the user to the presence of important operating and maintenance (servicing) instructions in the literature accompanying the appliance.

This page is intentionally left blank

# Quantum Evolution installation and user manual

## Contents

Description	Page No
Safety Precautions	8
Contents of packaging	9
Features	10
Front Panel	11
Rear Panel connections	13
System Connection diagram	15
Remote Control	16
OSD Description ( On Screen Display )	17
Menu Tree	18
Default Password	20
Main Menu	21
Menu Navigation	21
<b>DISPLAY</b>	21
Camera Covert	21
Cameras Name	21
OSD on/off	21
Set Display Sequence	22
Event Clear	22
Camera Control	23
<b>RECORDING</b>	24
Global Parameters	24
Normal Record	25
Alarm Recording	26
Motion Recording	28
Schedule Recording	30
Recording Priority	32
<b>SYSTEM</b>	33
Basic	33

## Quantum Evolution installation and user manual

Disk Format	36
Password Change	36
Client Account	37
Program Update	38
Sensor	40
Auto Delete Mode	40
PTZ Set-up	41
PTZ Control	42
<b>NETWORK</b>	43
DDNS	43
IP SET	44
<b>EVENT NOTIFICATION</b>	45
E-Mail Registration	45
E-Mail Report	46
Notification Out	46
<b>SEARCHING VIDEO FOOTAGE</b>	47
Date / Time Search	47
Calendar Search	48
<b>DOWNLOADING EVIDENCE</b>	50
LOG	52
<b>VISTA – VIEWER SOFTWARE</b>	53
Minimum PC Specification	53
Live monitoring	54
Recording and Playing back	55
Downloading of video from Quantum Hard drive to PC	57
Playback video downloaded to PC	60
Playback video on PC direct from Quantum hard drive	62
PTZ Control via software	64
<b>SET-UP</b>	65
Remote Set-up	65
Local Set-up	67
Firmware Upgrade	68

## Quantum Evolution installation and user manual

Explanation of on screen buttons	70
APPENDIX 1 – Alarm Sensor Installation	72
APPENDIX 2 – DYNAMIC IP (Supporting DDNS)	75
APPENDIX 3 – Setup for DVR port / Web server port using IP Sharing router ( Port Forwarding)	77
APPENDIX 4 – Making a partition on an External USB hard drive	79
APPENDIX 5 – System Specification	85

## SAFETY PRECAUTIONS

### CAUTION BEFORE USE

Please read this manual before installing or using the Vista Quantum DVR.

Please keep this manual in a safe place, to allow for future reference

For the safety and proper use, The DVR is marked with various symbols. Please read these to prevent injury of financial loss.

### INSTALLATION SITE

Ensure installation position is level, secure and adequately ventilated.

Avoid installing close to sources of humidity or water.



**CONTENTS OF PACKAGING**

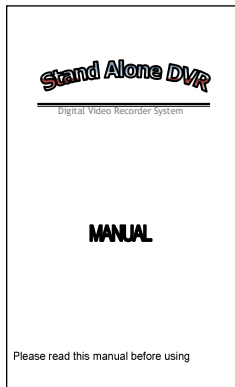

**User Manual**



**Power Cable**



**Remote Controller  
( Not included with  
4chn Non DVD  
units)**



**Battery**

## FEATURES

### • Convenience

- User-friendly GUI ( Graphic Based User Interface)
- Easy-to-use menu structure
- Easy-to-use recorded data search (Time, Date, Motion, Alarm)

### • Stability

- Auto restart after power interruption
- DB structure offers data stabilization and best storage utilization

### • Expandability

- Various remote multi DVR's can be controlled by Web browser (PC Client System)

### • Technology

- Embedded LINUX OS
- Maximum recording rate 100 fps
- High-resolution & high-quality MPEG-4 algorithm
- Using Water marking & scrambling technologies,
- MPEG-4: 1 ~ 2 Kbytes per image with resolution 360x240

### • Functionality

- Variable recording function (normal, alarm, motion, schedule)
- Full channel real-time monitoring
- Live monitoring, recording, playback, backup and remote access simultaneously
- Multi channel playback
- Variable events notification to e-mail, buzzer or PC Client system

## FRONT PANEL



### (1) LED

- REC: Recording status (When recording is on, the red light is blinking)
- PWR: System Power On/Off (When power is on, the green light is lit up)

### (2) USB 2.0 PORT

- USB2.0 connector, for downloading to USB pens / drives (plus upgrading firmware )

### (3) POWER BUTTON

- System Power On/Off

### (4) NUMERIC & CHARACTER

- Input for numeric's & letters

### (5) MENU

- Displays the menu on the screen

### (6) SEARCH

- Entering search mode

### (7) PLAY ►►

- Playback of the recorded data
- When in play mode press again to enter fast forward mode.

### (8) REWIND ◀◀

- Playback on the reverse

### **(9) PAUSE ( || )**

- To freeze picture on playback mode and live mode.

### **(10) STOP / EJECT ( ■ )**

- To stop playback and go back to live mode.
- To eject DVD-RW

### **(11) REC ( ● )**

- It starts & stop manual recording of relevant camera in a full screen live mode.

### **(12) VOL ( ▲ ▼ )**

- To make the volume up and down.

### **(13) AUDIO (8/16CH only)**

- When user select "audio" key, available audio will be switched.

### **(14) ARROW KEY**

- Moves the cursor while in menu mode
- Selection of multi screen functions

### **(15) SELECT**

- Menu selection

## REAR PANEL CONNECTIONS

### < 4Channel Quantum >

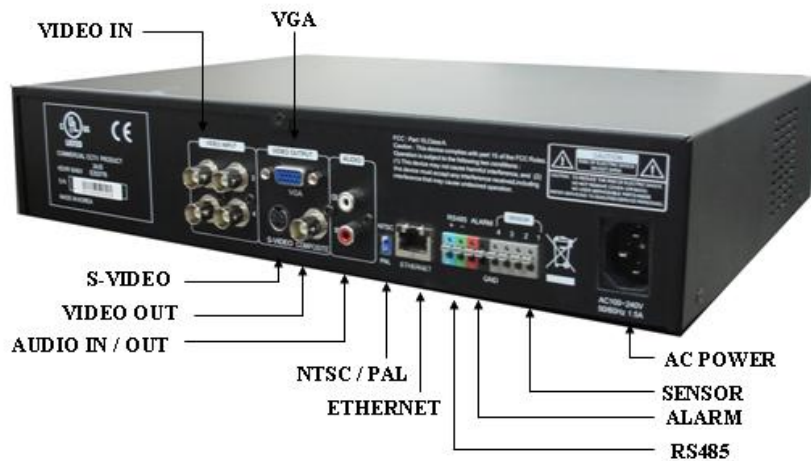

### < 8/16 Channel Quantum >

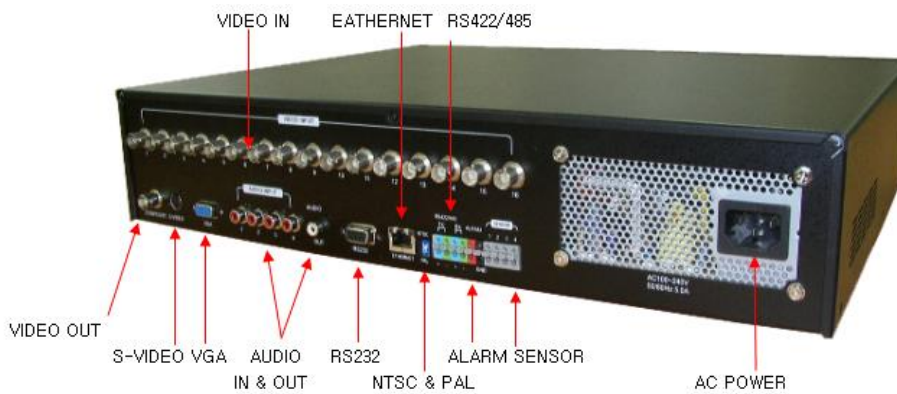

#### (1) Video Input (BNC)

- 4,8,16 Camera input (1.0 v p-p, 75Ω)

#### (2) Video Out (BNC / S-VIDEO / VGA)

- Composite Output through BNC / S-VIDEO / VGA

#### (3) Line Audio Input

- 4 Audio Input on 8 and 16 channel, single audio on 4 channel

### **(4) Audio Output**

- 1 Audio Output

### **(5) RS232 (8/16 channel only)**

- 1 Serial Communication

### **(6) Network Port (RJ-45)**

- Available to monitor live screen and recorded data on the HDD through Internet or LAN

### **(7) DIP switch (NTSC/PAL Video Selection)**

- Selectable either NTSC or PAL

#### **ATTENTION**

When the video format is changed, the system should be re-booted; the video format should be selected before booting.

### **(8) RS 485**

- 1 Serial Communication for Pan / Tilt Camera

### **(9) Alarm/Sensor**

- Alarm / 4 Sensor input / 1 output port

### **(10) AC Power**

- 110~240 Vac

SYSTEM CONNECTION DIAGRAM

< 4Channel Quantum >

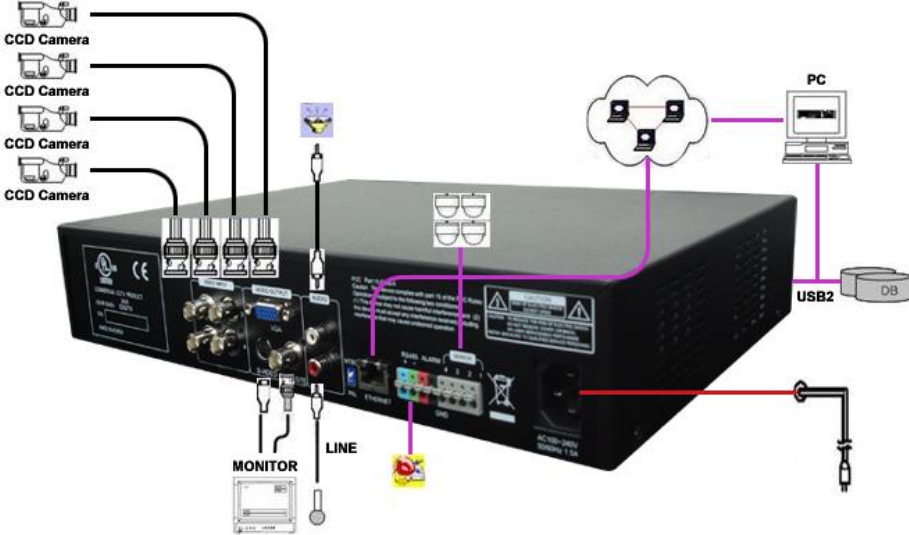

< 8/16 Channel Quantum >



**REMOTE CONTROL (Not included with 4 Chn Non DVD units)**



1. Power: Power ON/OFF
  2. Rec: Start & Stop Recording
  3. Ⓞ-Ⓢ Key for figure and character
  4. P/T/Z: Entering PTZ menu directly
  5. OSD: Operating OSD ON/OFF
  6. SEQ: Key for SEQ operation
  7. LOG: Direct access Log list
  8. INFO: Direct access system Info.
  9. ID: Reserved.
  10. MUTE: Audio Mute
  11. AUDIO: Available audio switching when user select this key
  12. MENU: Entering system menu
  13. SEARCH: Entering search
  14. ARROW & SPLIT: Key moving left, right, up and down. Also, Screen split display shows
  15. VOL"+,-" : Up, down volume
  16. CH "+,-" : Up, down channel(s)
  17. ▶(▶) : Play(or fast forward)
  18. ◀ (◀) : Reverse play
  19. II : Pause
  20. ■ : Stopping playback
  21. Cam: Changing PTZ icon
  22. P/T: Pan &Tilt
  23. Z/F: Zoom/ & Focus
  24. DIS: Channel Division
- [21~24:doesn't work with Quantum Evo.](#)



OSD DESCRIPTION



Recording on

HD: 99%, this shows how much as a percentage is used on the Hard Disk Drive  
04-11-2008 15:26:12: It shows the system date & time

This shows; "Power fail", "USB stick in" "Network". You would see other icons as well if happens such as

# MENU TREE

Menu tree

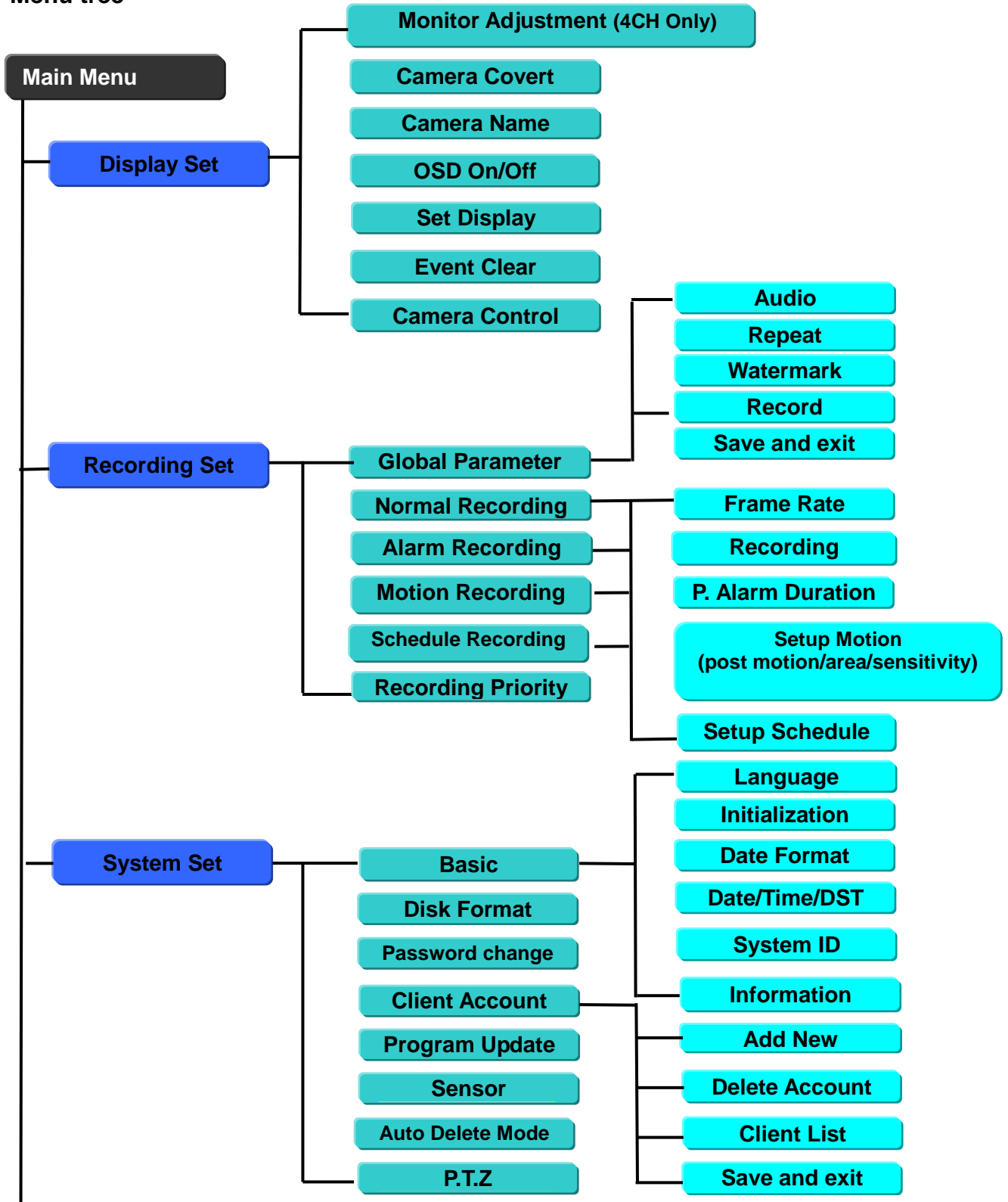

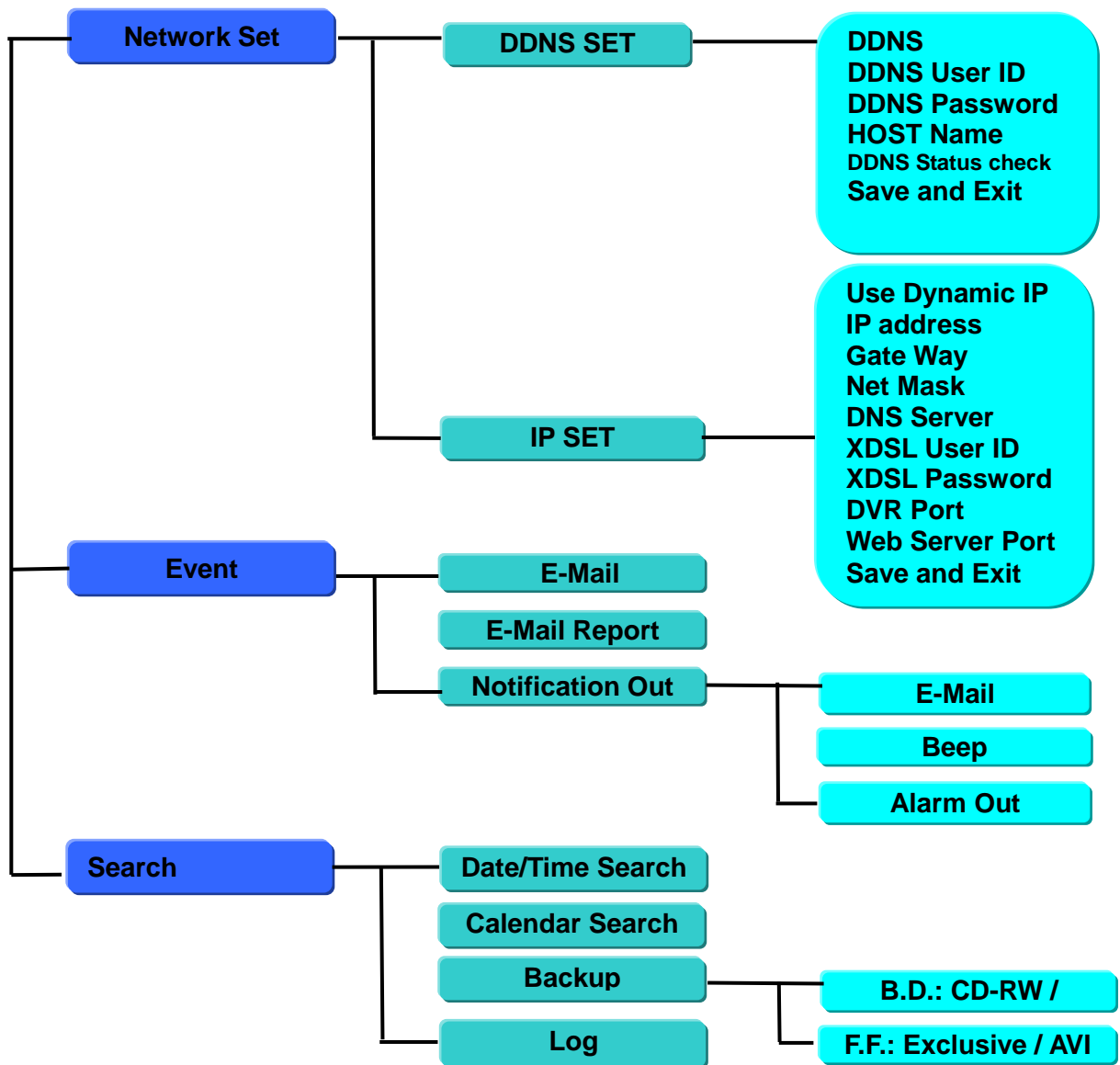

## DEFAULT PASSWORDS

### Front Panel

Password is required if you need to enter the menus; down power; stop recording or changing an IP setting.

A prompt will be displayed asking for password.

The default Password is: **00000000** (8 zeros)



### Viewer Software

When using the supplied browser software the following password will be required.

User ID is "**admin**" (not case sensitive).

Password is "**00000000**" i.e. 8x Zero's

(Admin ID cannot be changed, as this is the full administrator ID)

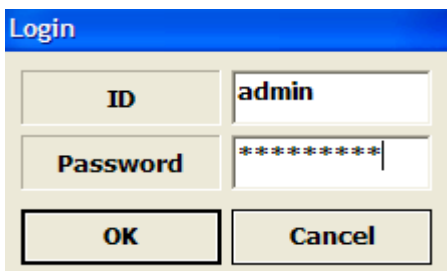

## MAIN MENU

To enter the set-up menu press the Menu button and enter the password (default password is 00000000 – 8 zeros). The following screen will be displayed.

### Menu Navigation

All menus are navigated around using the left / Right / Up / Down and the SEL Select button. To step back through the menus press MENU button



## DISPLAY

### Camera Covert

Cameras can be hidden from the viewer in live or play back mode. Turn the camera on or off using the left and right buttons around the SELECT button.

### Camera Name

Each camera can be titled using the Alphanumeric buttons on the front panel.

### OSD On/Off

OSD on/ off: Selecting whether the time and date etc is shown on the screen or not.

## Set Display Sequence

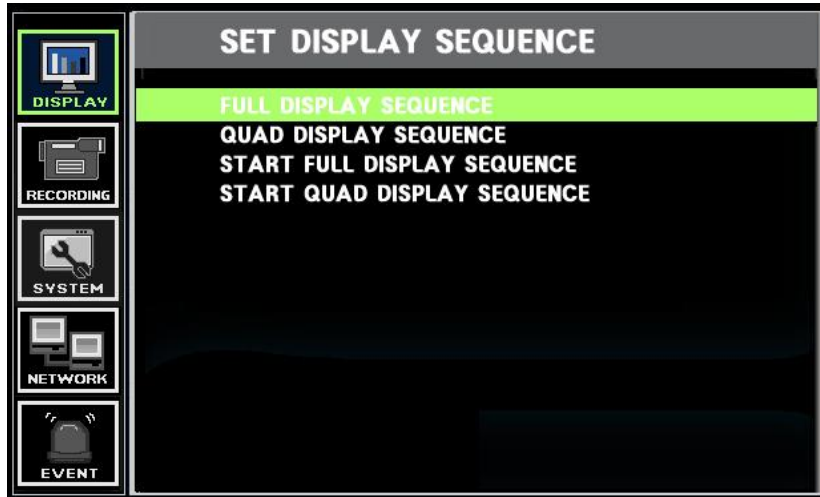

Within the FULL DISPLAY SEQUENCE an a switching sequence of all or a selection of cameras can be set, with individual times allocated to selected cameras.

Within the QUAD DISPLAY SEQUENCE a selection of screens displaying 4 cameras at a time can be set-up, the quad displays are fixed e.g. Quad 1 contains cameras 1,2,3 and 4; Quad 2 contains cameras 5,6,7 and 8 etc

Use the START options to start the sequences running. To stop them simply select a single camera from the front panel.

### Event Clear

This is used to erase the list, in the memory, of previous events such as alarm activations.

## Camera Control



The picture displayed from each camera can be individually adjusted to balance the multi screen view.

## RECORDING

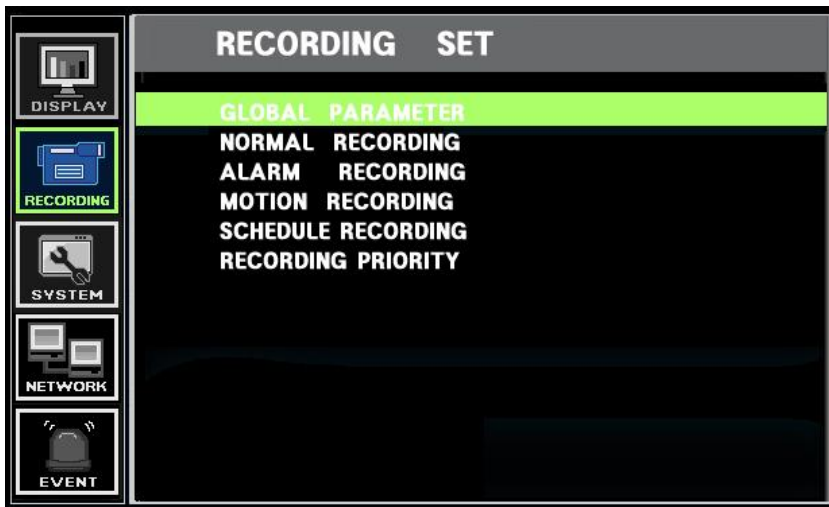

### **Global Parameter**

Within this section:

1. The 4 audio tracks can be switched on or off, Note Audio tracks 1, 2,3and 4 are linked to channels 1,2,3,and 4. (only one audio track on 4 channel unit)
2. Repeat recording can be set to continually overwrite or stop when the drives are full.
3. Watermarking should be set to on, this allows the supplied software to verify the downloaded information to ensure it has not been tampered with or changed.
4. Recording resolution can be set to 2CIF -720 X 288 (giving 50ips recording) or CIF - 360 X 288 (100ips).

These settings are applied to all channels



## Normal Recording

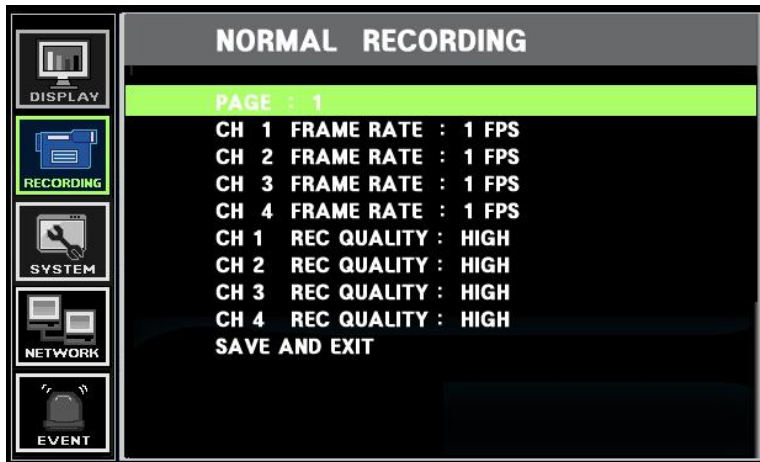

The frame rates can be set individually per camera, the number of frames available is dependant on the resolution set (within GLOBAL PARAMETERS) e.g. 720X288 allows 50ips across the cameras, and 360X288 allows 100ips across the cameras.

On the 8 and 16 channel units go the PAGE 1 and use “→” arrow to move to access further channels

### Recording Quality

Three levels of compression: High, Mid, Low. Can be set per channel.

### Save and Exit

All the values set-up will be stored and screen will step back to higher level menu..

## Alarm Recording

There are 4 Alarm inputs on the rear of the Quantum these can be used to initiate the Alarm record mode.

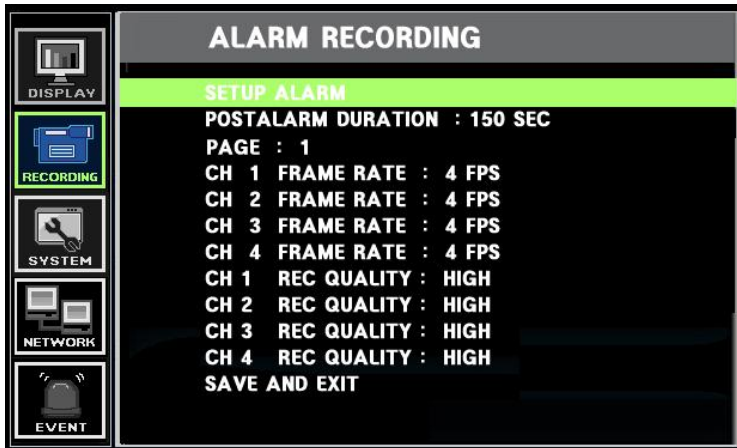

## Setup Alarm

Using the following screen, the individual alarm inputs can be configured to activate recording on any of the 16 cameras

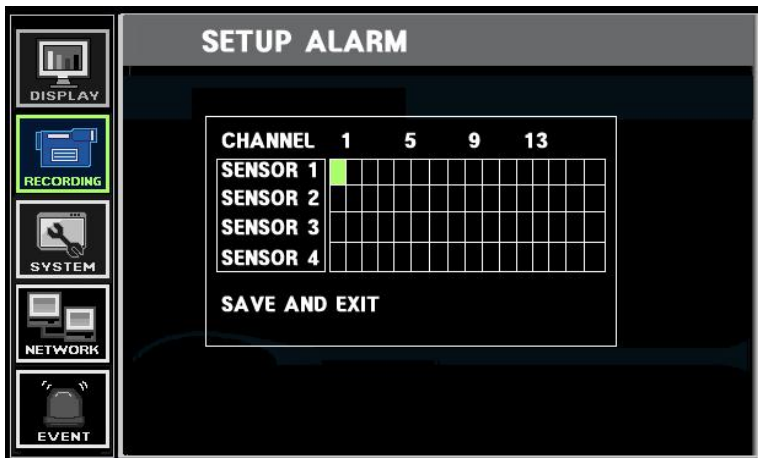

## Post Alarm Duration

After alarm activates, it sets how long the recording continues. The value is selectable among: 5/ 30/ 60/ 90/ 120/ 150/ 180/ 210/ 240 sec.

## Frame rates

The frame rates can be set individually per camera, the number of frames available is dependant on the resolution set (within GLOBAL PARAMETERS) e.g. 720X288

allows 50ips across the cameras, and 360X288 allows 100ips across the cameras. On the 8 and 16 channel units go the PAGE 1 and use “→” arrow to move to access further channels.

### **Recording Quality**

Three levels of compression: High, Mid, Low.

### **Save and Exit**

All the values set-up will be stored and screen will step back to higher-level menu.

## Motion Recording

Motion on any channel can trigger recording of that camera

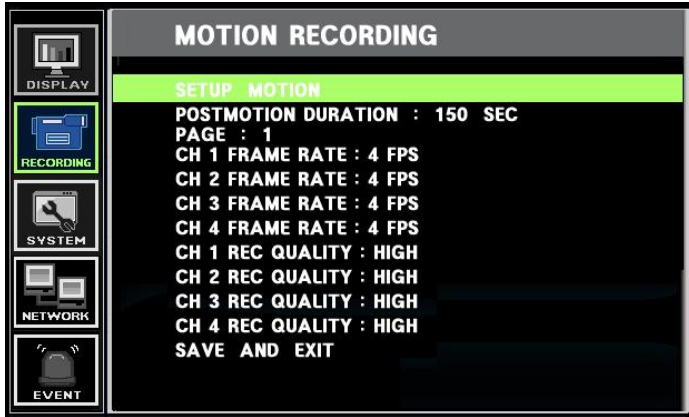

### Setup motion

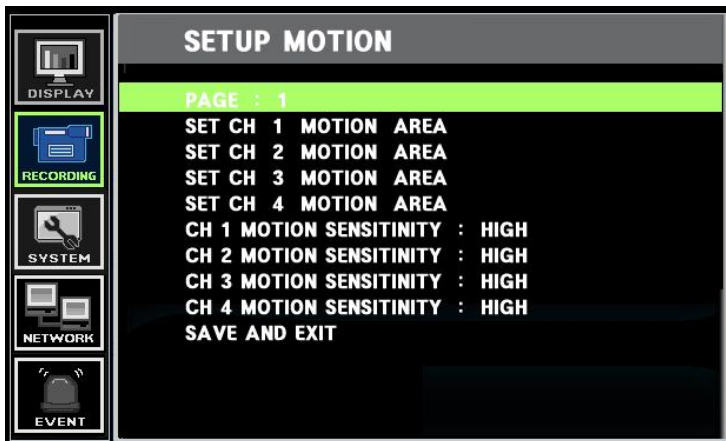

### Set CH. Motion Area

The following will be displayed when selection from the menu is made.

			1	2			
			3	4			

The detection area is divided 8x6 cells. By default all-cells are in active mode. Use the arrow keys to move around the screen and the SELECT button to toggle between active and disabled. Set the cells over the areas of interest to active state.

### **Post Motion**

This sets the how long the recording lasts after motion is detected. The time can be set between 30 ~ 240 sec.

### **Motion Sensitivity**

It has 3 settings of: High, Mid, Low, these are set dependant to site conditions.

### **Frame rates**

The frame rates can be set individually per camera, the number of frames available is dependant on the resolution set (within GLOBAL PARAMETERS) e.g. 720X288 allows 50ips across the cameras, and 360X288 allows 100ips across the cameras.

On the 8 and 16 channel units go the PAGE 1 and use “→” arrow to move to access further channels.

### **Recording Quality**

Three levels of compression: High, Mid, Low.

### **Save and Exit**

All the values set-up will be stored and screen will step back to higher-level menu.

## Schedule Recording

Recording can be set so that it is only active at certain times of the day

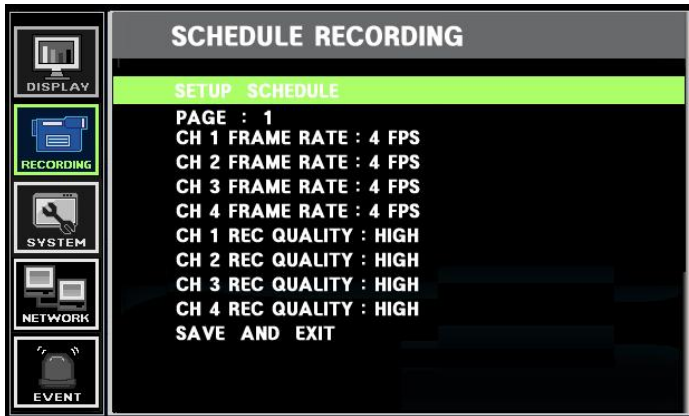

### Frame rates

The frame rates can be set individually per camera, the number of frames available is dependant on the resolution set (within GLOBAL PARAMETERS) e.g. 720X288 allows 50ips across the cameras, and 360X288 allows 100ips across the cameras.

On the 8 and 16 channel units go the PAGE 1 and use “→” arrow to move to access further channels.

### Recording Quality

Three levels of compression: High, Mid, Low.

### Setup Schedule

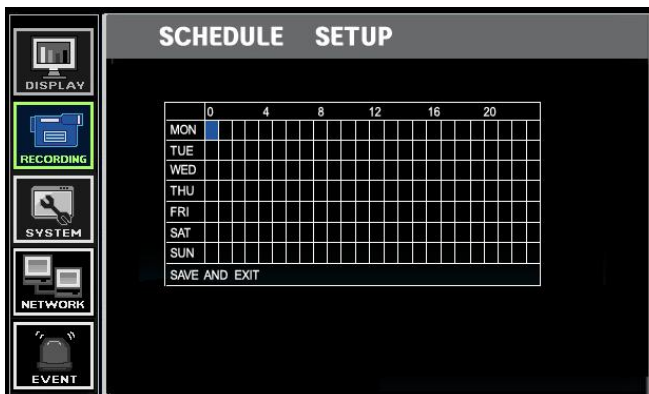

When setup schedule is selected the following screen will appear, showing a whole week, in hour blocks. To allow recording within a specific hour this block must be highlighted. Use the arrows to move around the table and the SELECT button to highlight blocks.

### **Save and Exit**

All the values set-up will be stored and screen will step back to higher-level menu.

## Recording Priority

The RECORD PRIORITY allows the mixing of the various record methods to customize the individual site requirements.



The Quantum always looks for the method set to the highest record priority, best explained in an example:

If a system requires that between 8pm and 6am each day it should only record if Motion is seen, at a rate of 2 frames per second per camera. For the rest of the time each camera should record at 1 frame per second per camera. The Priority settings should be:

Priority 1: SCHEDULE (With the schedule set as previously described)

Priority 2: MOTION (The Normal record settings would be set to 1 frame per cam)

The Quantum will record in Schedule mode for the period of time that the schedule is set active for, once outside the scheduled time periods, e.g. in an inactive period of the schedule, the Quantum will then look to the second priority and then only record when motion is seen.



## SYSTEM

The SYSTEM SET menu is where all the non-recording based settings are configured

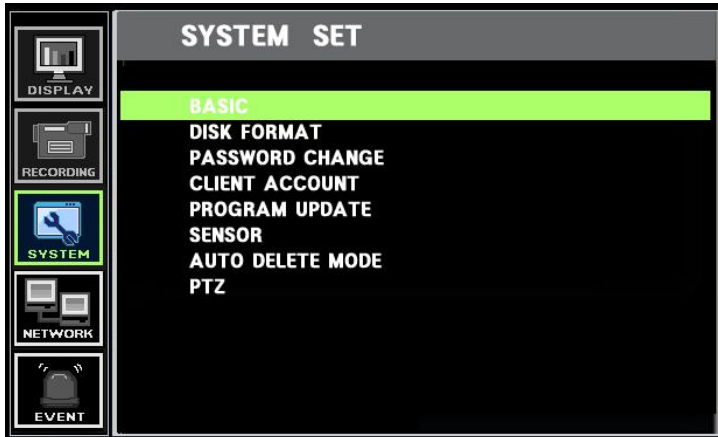

## Basic

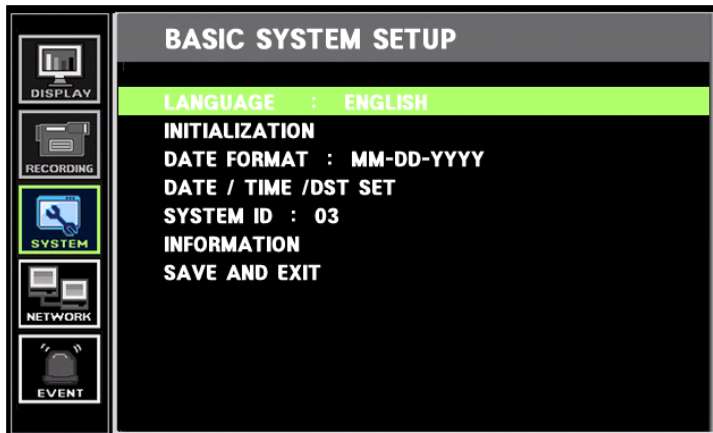

## Language

The default is English. French, Portuguese, Spanish, Italian, German, Dutch are also available.

## Initialization

All the menu value will be returned to the factory default. To carry out this function the system recording will have to be turned off.

### Date Format

Can select among the formats, mm-dd-yyyy / dd-mm-yyyy, yyyy-mm-dd. If date format needs to be changed, recording will have to be turned off.

### Date / Time / DST Set



### NOTE

#### **PLAYBACK FOLLOWING TIME CHANGE**

The DVR uses the time and date to index video on the hard disk drive so you can find it later. Changing the time can cause the DVR to work improperly when you try to play back video. If you set the hour ahead, this is not a problem. But, if you set the hour back, there will be more than one recording at the same time.

Such as during the October Daylight Saving Time changeover, if you try to search for video between 1 am and 2 am, the recorder may not operate properly because there will be two hours of recorded video during this time period. To view video during this overlapping time period, you must start playback before 1 am, then recorder will play both hours between 1 am and 2 a.m.

You cannot do a backward search through the overlapping time. But, you can do forward search.

### SYSTEM ID

The remote control can be used to control up to 16 Quantum's, the ID number on each can be set to a unique address so that the remote will only control one at a time if they are in close proximity.

Use the right arrow to change the ID number.

To select a unit on the remote control press the ID button, followed by the number, followed by the ID button again. The LED will flash slowly.

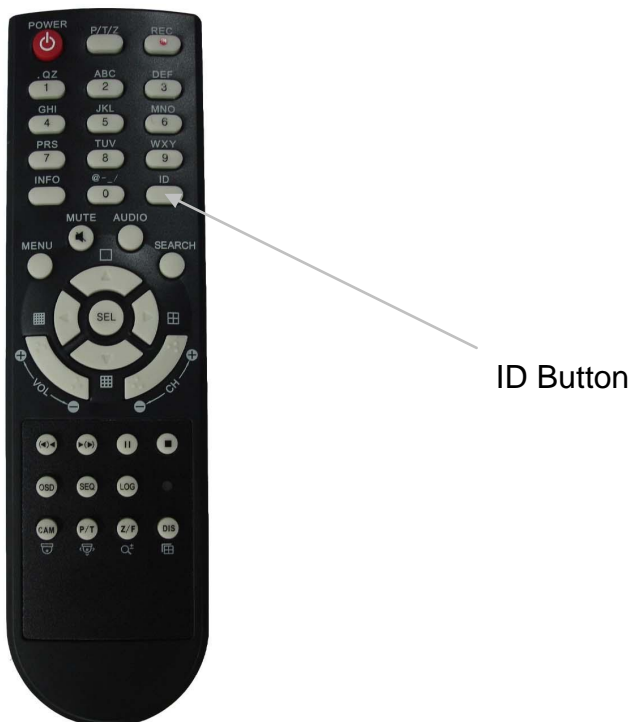

### Information

The Information Screen shows the hard disk size, current firmware revisions, IP address and MAC address

## Disk Format



Formatting of the drive is used when new drives are installed or you need to wipe all information on the disk.

## Password Change

The password can be change from the factory default to a more secure one, a note of any new password should be taken and stored in a secure place.

## CLIENT ACCOUNT



When viewing over a network up to 6 connections can be made simultaneously, one can have complete control e.g. view live and playback, and the other 5 can view live only.

### ADD NEW ACCOUNT

Network users can be set up under this menu; a name and password need to be entered for each account.

Once setup they will appear below in the Client List.

## PROGRAM UPDATE

Always turn off: Recording, Playback and Network access while upgrading the unit

The latest firmware version can be upgraded through USB 2.0 Port using Memory Stick. When the memory stick is inserted to the USB port on the front panel, the

following symbol  will be shown on the bottom right corner of monitor.

Enter “menu”-> “System Set”-> “Program Update”. If the system recognizes the new firmware then, “New program found” will be displayed on the screen.

Next press the “SELECT” button.

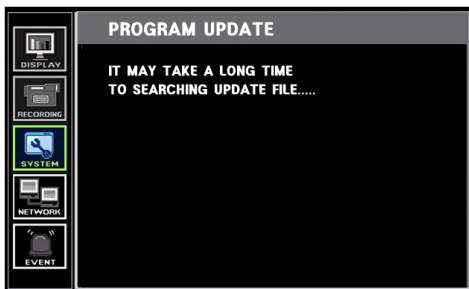

Processing percentage will be displayed.

**NOTE.** If the system doesn't recognize the new firmware, “New program not found” will be displayed.



2. USB compatibility has been tested successfully with: Lexar, Jumpdrive 128/256MB, Sandisk Mini, Cruzer 128MB & Cruzer Micro 256MB pen drives.

3. Always turn off: Recording, Playback and Network access while upgrading the unit

4. After updating program, reboot is required, simplest way is to pull the power plug out of the back, wait for 10 seconds and repower..

## SENSOR

The 4alarm inputs and 1 output on the rear of the Quantum can be configured to be normally open or closed.

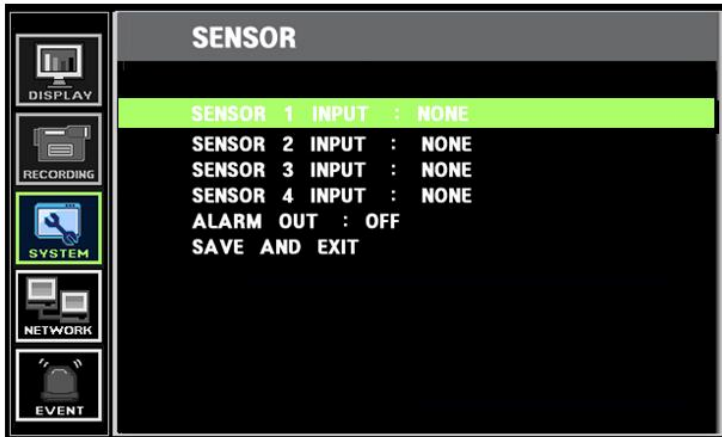

## AUTO DELETE MODE

Auto delete mode can be configured to prevent playback of images that are more than a defined number of days old. This is legal requirement in certain regions.

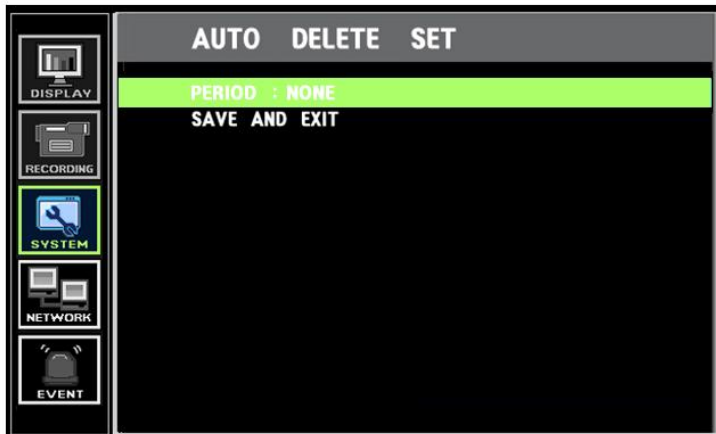



### PTZ SET-UP

1. Select the PTZ option within the System / Basic menu, the following screen will appear.

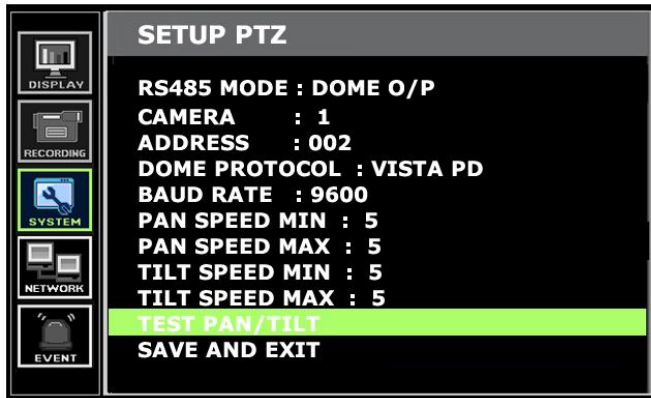

2. Select the Camera input number required,(e.g. the physical connection on the rear)
3. Set the RS485 Address given to the Dome camera
4. Set the Protocol Required: Vista PD, Pelco D or Pelco P
5. Set the BAUD rate: 9600 for Vista PD and 2400 for Pelco
6. Set the Max and Minimum pan and tilt speeds. When a left/right/up or down command is sent to the dome the dome will start at the min speed, after 2 seconds it will jump to the max speed. If 2 speeds are not required set both max and min to the same value. The higher the number is set to, the faster the speed.
7. Select TEST PAN /TILT to run a test routine
8. When settings are correct select SAVE AND EXIT.

### PTZ Control

To select the Telemetry mode press the MENU key followed by the SEL key, PTZ MODE will appear in the top right of the screen, as shown below.



Press the SEL key to show the following help screen.

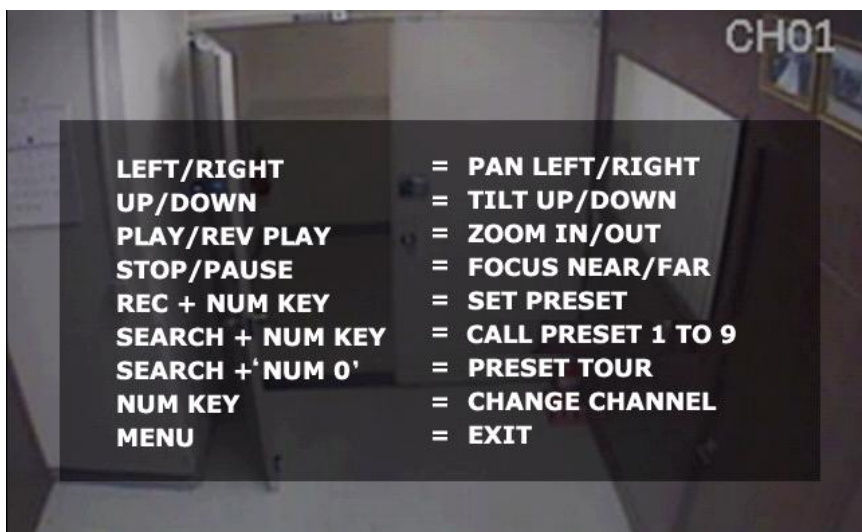

This details the various key presses required to control the PTZ cameras  
Press SEL to clear this from the screen.

## NETWORK

To enter Network set menu, system ask password (Default is 00000000).

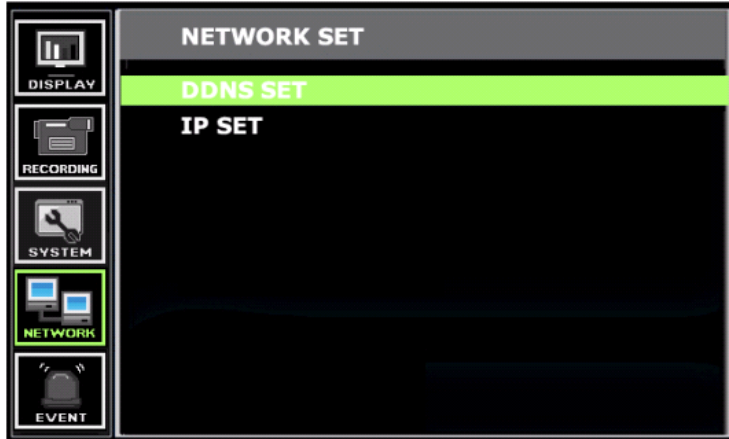

With in the Network Set menu the DDNS (Dynamic Domain Named Server) and IP addresses can be set.

## DDNS

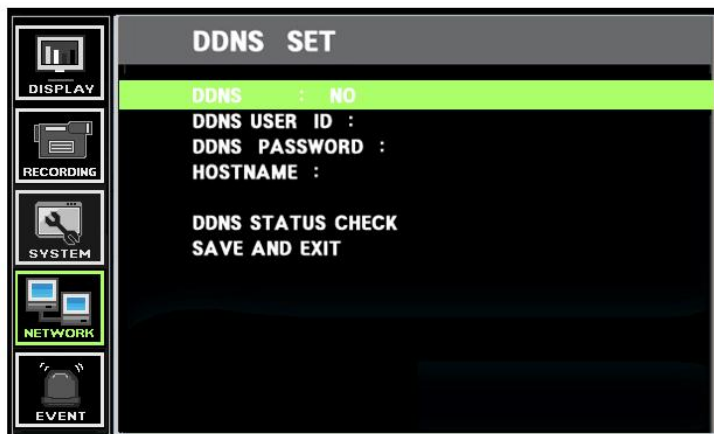

What is DDNS?

DDNS is a service that maps Internet domain names to IP addresses. DDNS serves a similar purpose to DNS: DDNS allows anyone hosting a Web or FTP server to advertise a public name to prospective users.

Unlike DNS that only works with static IP addresses, DDNS works with dynamic IP addresses, such as those assigned by an ISP or other DHCP server.

What this means is that the DVR does not need a Static IP address to be available for viewing remotely over the World Wide Web.

Please refer to Appendixes 4 and 5 for direction on how to set up the DDNS service.

## IP SET

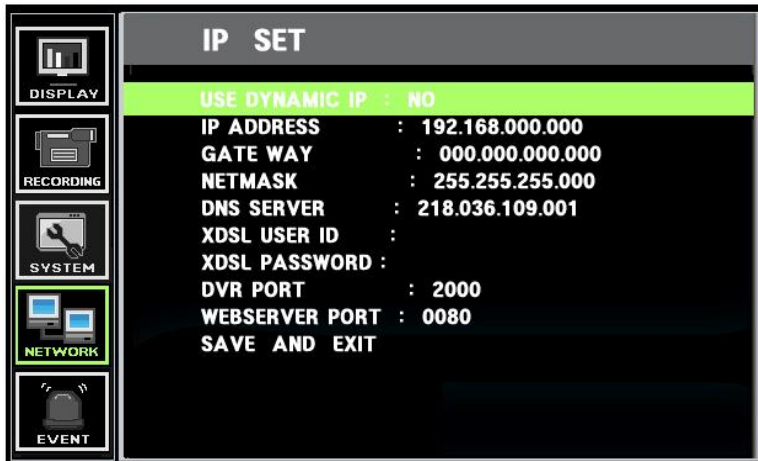

When a fixed IP address is being used, the Use Dynamic IP should be set to No  
The IP Address, Gateway and Subnet Mask need to be set, these will generally be given by the Network Manager.

XDSL refers to all types of Digital Subscriber Line such as ADSL and SDSL

## Event Notification

This section is used to inform the user as to an event occurring, this can simply be by the sounding of a buzzer or by sending an E-mail to a predefined address.

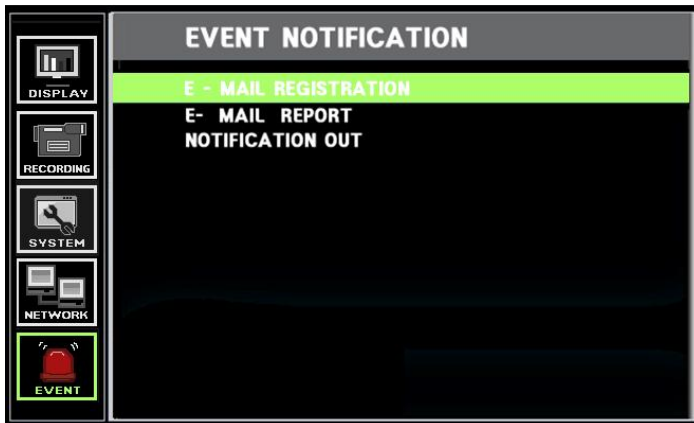

## E-Mail Registration

Within this section up to 3 users can be set-up to receive an email on the occurrence of an event such as Video Loss / Alarm / Motion or Power Loss. An E-mail will only be sent if the Quantum is sitting on a network with access to the Internet, e.g. through a router.



The e-mail addresses are set via the alphanumeric buttons on the front panel.

For SENDER MAIL ID and SENDER DOMAIN, this is best explained by an example, if the following is input:

SENDER MAIL ID: QUANTUM4

SENDER DOMAIN: NORBAIN.CO.UK

Then the receiver will receive a mail from [QUANTUM4@NORBAIN.CO.UK](mailto:QUANTUM4@NORBAIN.CO.UK)

Note: This is not a valid e-mail address for replies.

SEND TEST MAIL sends a test E-mail to the addresses so allowing the installer to verify if the setup is correct.

### E-mail Reports

As well as e-mail on event activations the Quantum can be set to send a report of what has happened daily / weekly or immediately. This sends a mail containing the log report.

### Notification Out

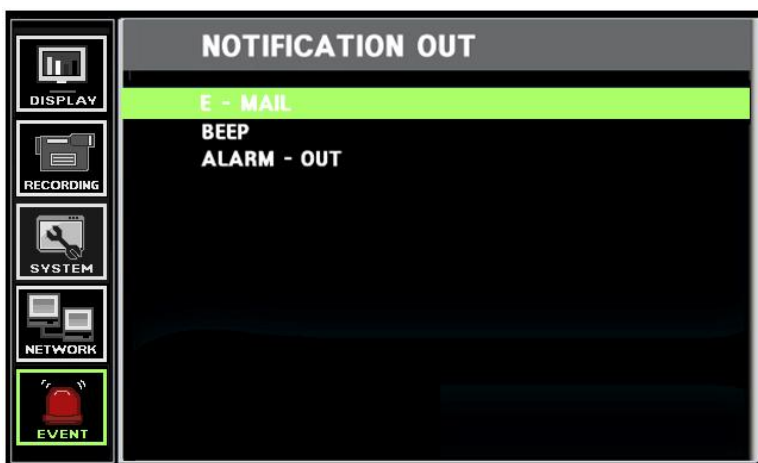

When an event (e.g. Video loss, Alarm, Motion or power loss) occurs the following actions can be triggered:

E-mail – As described in previous section

Beep – The buzzer can be sounded.

Alarm out – The relay contact on the rear of the unit can be closed.

## SEARCHING VIDEO FOOTAGE

To access the search option, press the SEARCH button on the front panel. The following screen will be displayed.

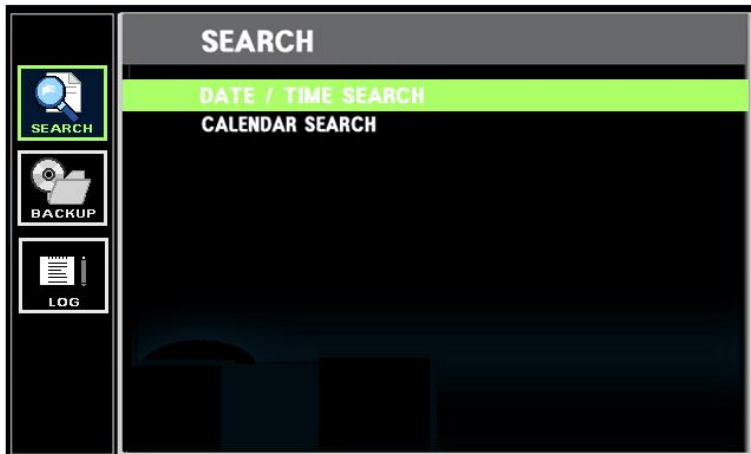

### Date / Time Search

If you select date/time search, the following will be shown.



**EVENT:** Allows the user to select between ALL, MOTION or ALARMS. Select required option by pressing the right arrow.

ALL – The search is for a block of video within the times defined

MOTION – The search is for any motion events within the times defined

ALARMS – The search is for any alarm activation within the times defined

**HDD:** Allows searching on either the INTERNAL hard drive or an EXTERNAL device plugged onto the USB port. Select required option by pressing the right arrow.

**DATE:** Allows the user to select the start time required for the search. Set the date by highlighting the DATE option , then press SEL the select button, use the alphanumeric buttons to select the time and date required.

Once the selection criteria is entered move to play by pressing the down button and press SEL to play the video.

### Calendar Search

Following screen shows when “Calendar search” is selected.

YEAR	2008					
MONTH	3					
SUN	MON	TUE	WED	THU	FRI	SAT
						1
2	3	4	5	6	7	8
9	10	11	12	13	14	15
16	17	18	19	20	21	22
23	24	25	26	27	28	29
30	31					

The Calendar search gives a graphical representation of when video is recorded on the hard drive.

The year and month can be selected, this month is shown as a calendar on the screen, any day which contains recorded video will be indicated by a highlighted number in white.

Move to the desired day by using the up / down / left / right buttons, Select the day by pressing SEL.



The following screen will be displayed.



In this example there is only recording between 4 and 5pm on the particular day, use the left and right button to move to the required hour and press SEL.

The following screen will be displayed



In this example the recording there is recorded video between 4.30 and 4.36. Use the left and right buttons to move to the time required and press SEL.

Video will start playing from the selected time.

### DOWN LOADING EVIDENCE

Once the required video has been found, it may be necessary to down load it for evidential purposes. This can be done either onto the internal CD/DVD-R writer or via the USB port on the front of the Quantum.

To do this press the SEARCH button and using the down button move to BACK UP, once highlighted press SEL, the following screen will be displayed.



#### Backup Device

This allows selection between the internal CD /DVD-R writer and the FLASH option via the USB port, when highlighted use the right arrow to toggle between the options.

#### Device Format

Format for **CD/DVD-R** is **not** needed. When using **CD/DVD-RW**, format **should** be done first.

#### File Format

EXCLUSIVE or AVI file options are available.

If evidence is downloaded as an AVI file it can be played with Windows Media Player (this format is not secure as evidence)

If evidence is downloaded as an Exclusive file, the Quantum will download bespoke player software on to the CD / DVD or USB device along with the evidence. This

means that no special software is required, by the reviewing PC. This format is secure and watermarked.

When File format is highlighted use the right and left buttons to toggle between the options.

### **From/ To**

You can set up the start and stop time which is required to be backed up to the internal CD/DVD-R or USD device.

Highlight this option, then press SEL, then use the alphanumeric buttons to set the time and date. Repeat for the end time.

### **Channel**

1. When you select the EXCLUSIVE file format, the number of channels to be downloaded can be selected. Anything from a single channel to all 16 can be selected.
2. When the AVI file format is selected only one channel can be downloaded.

### **Calculated Backup size**

Once the time and date and file format have been entered, it is necessary to confirm that the size of file created will not exceed the size of memory available on the disk or USB device. Move to Calculated Back Up Size and press SEL.

The Quantum will then calculate storage space required for download file. This will be displayed in the required space section. AS long as the Required space size is smaller than the Free/ total space, then move to Transfer.

### **Transfer**

When Transfer is highlighted press SEL, the downloading will start. Percentage done during downloading will be shown.

Note: Network should be disconnected during downloading to internal DVD/CD-R disk. If network is connected, connection will be terminated during "making backup file".

\* USB compatibility: the following have been tested

Lexar JumpDrive      128/256MB

SanDisk Mini Cruiser    128MB, SanDisk Cruiser Micro 256MB, 512GB, 1GB  
DVD/RW Plextor        PX-716UFL  
Lite-On CD/RW         (LTR-52327SX)

## LOG

The log file contains information on the following:

Alarm activations

Motion events

Power loss

Video loss

Remote access

A total of 1089 events can be recorded the oldest being overwritten when a new one occurs, they can be viewed all together or individual types as a list.



Select the type required and press SEL the list will be displayed as follows:



## VISTA – Viewer software

Each Quantum comes with a license fee viewer software to view the Quantum across a network.

To be able to do this the recommended minimum specification for the PC is as follows:

### Minimum PC specification (4, 8/16CH)

- > CPU: 4CH- Pentium IV min 750MHz over, 8/16CH- Pentium IV min 1.7GHz.
- > Graphic Memory: 4CH- min 32M, 8/16CH – min 64M.

### Installing software

When you put Vista Network installation CD into your PC, it will auto run and lead you through an installation wizard. Follow the instructions. Once the software is loaded it will automatically run.

The following window will appear. To connect to the Quantum, type in the units IP address then press “OK” button.



### Log In

When Log in window appears, type in the ID & Password. (Default ADMIN and 00000000)  
Then, click “OK”, which starts the live monitoring.

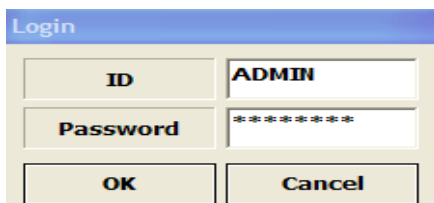

## Live Monitoring

The software is best viewed on the monitor resolution, 1024 x 768.

### Choosing cameras - Channel Button

Live cameras are indicated by a highlighted button. To select a single full screen view of any camera click on the corresponding button, this will turn green



## Multiscreen Views

Multiscreen division can be done during both live and playback. As seen in picture, 1, 4,8,9,16 division are available.



Click the relevant button for required multiscreen option

## Termination of live monitoring

Live monitoring will be terminated when user clicks the “Live Off”  button.

Live monitoring will be re-started when user pushes “Live On”  button.

## System & Local



SYSTEM refers to the DVR.



LOCAL refers to the Remote PC as client

## Recording & Playback



The buttons above are from the left: Step backward / Reverse play / Play / Pause / Record / Stop / Step forward.

Repeated pressing of the play or reverse buttons click makes speed increase.

Pause is temporary stop.

If user wants to play the video forward during reverse, push the stop key and then push play button.

## System & Local recording

- 1) System recording – allows the PC user to remotely turn the recording on and off.



To start the recording on the DVR via client PC, select SYSTEM, then click on the record button, it will turn red.

Note: Only Admin level users can control 'recording on/off' via the network connection.



To stop recording click the record button again, the system will ask for the password to be entered, then click OK

The record button will change to orange.

## Quantum Evolution installation and user manual

2) Local recording –allows the PC user to download information from the Quantum to the PC.



To record video onto the PC click the LOCAL button, it will turn green, and then click the record button, it will turn red.

Both Admin and User levels can carry out this



## Downloading of video from Quantum Hard drive to PC



This button is used to start the download process from Quantum to PC

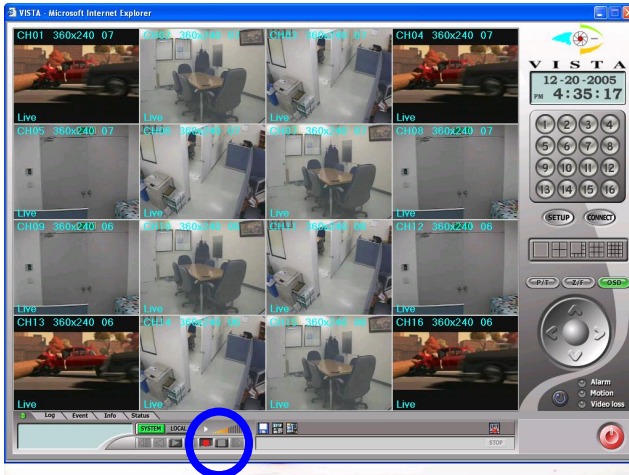

Click the Download button

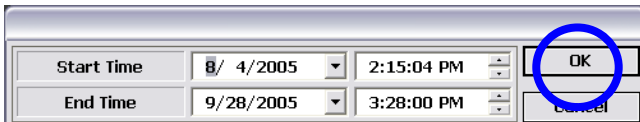

The following screen will appear, enter the start and end time then click "OK"

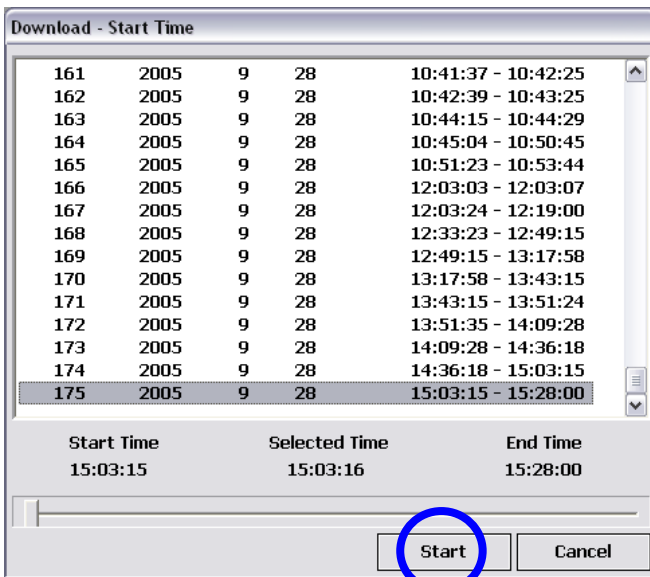

The Window on the left will show a list of video in 500Mb sections within the time period set.

Select the period within which the required start time sits, the exact time can be selected using the slider at the bottom of the screen. Once selected click "START"

## Quantum Evolution installation and user manual

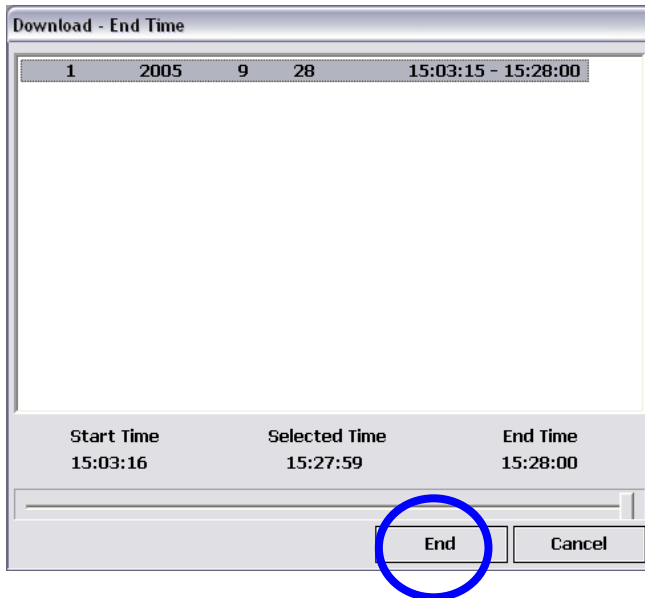

Follow the same routine to select the End Time of the section to be downloaded.

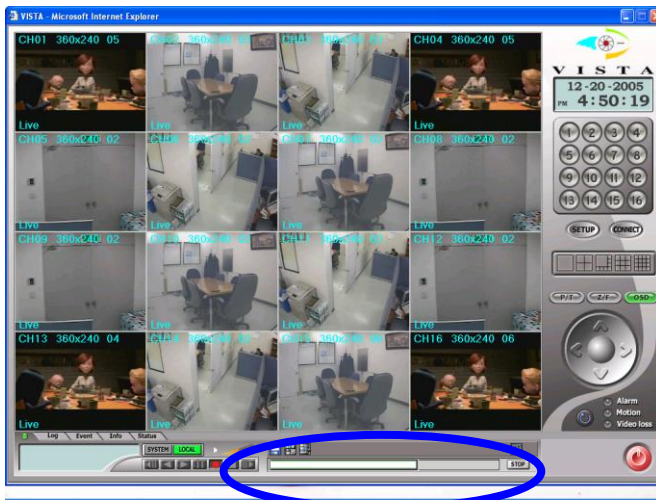

The process bar will be shown at the bottom of the screen to show progress.

Please wait till download is finished.



When downloading is finished, click the LOCAL button, which turns to green. Then, push play (▶) button.

## Quantum Evolution installation and user manual

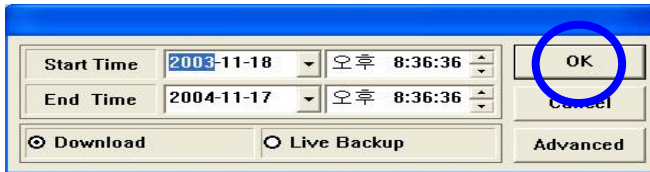

Select 'Start Time' & 'End Time' and check (v) 'Download'. Then click "OK".

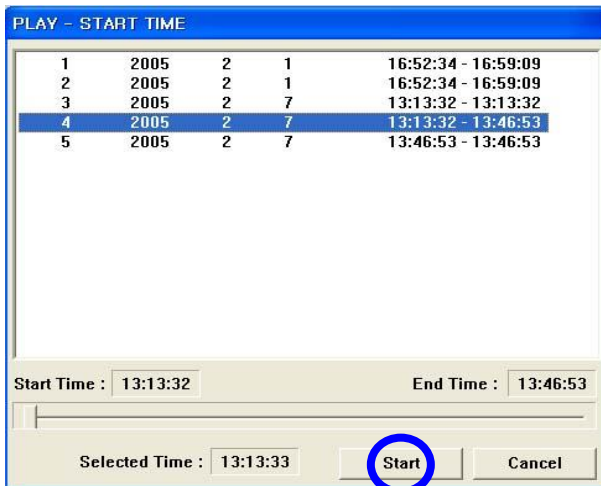

The download list on the left will be shown. Select the section, which you want to play.



The play back will be shown in the format shown on the left.

## Playback video downloaded to PC

To play back video downloaded to the PC.



Click the LOCAL button, it will turn green.



Next Click the Play (▶),

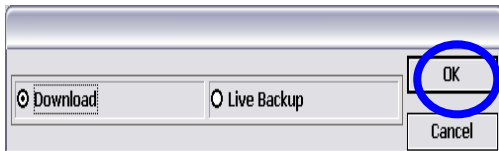

The window on the left is shown.

**BACKUP** - Refers to video downloaded from the system HDD to Client PC.

**LIVE BACKUP** – Refers to video which is saved direct from the live screen to the PC HDD.

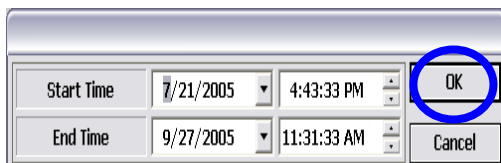

Click ok and box on the left will appear, set the start and stop times, then click “OK”

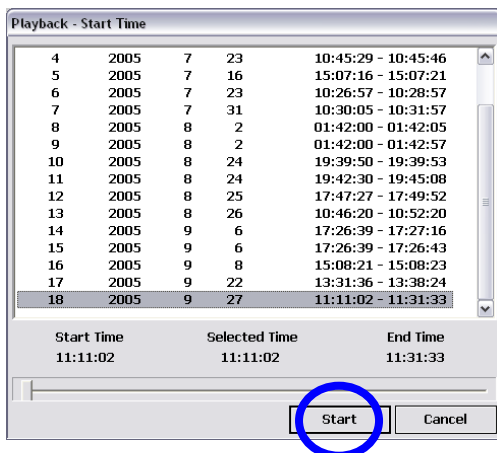

The following list will appear it will give the requested video broken down into 500Mb segments, highlight relevant segment and click “START”

## Quantum Evolution installation and user manual

Video will be displayed in the following screen, use the button described previously to pause / fast forward etc.



## Playback video on PC direct from Quantum Hard Drive

Playing back video on the PC direct from the hard disk storage on the Quantum.



Click the SYSTEM button, it will go green



Next click the Play button (▶),

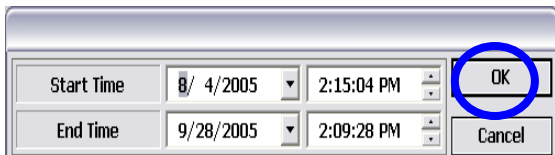

The window on the left will appear, select the start and stop time, then click "OK".

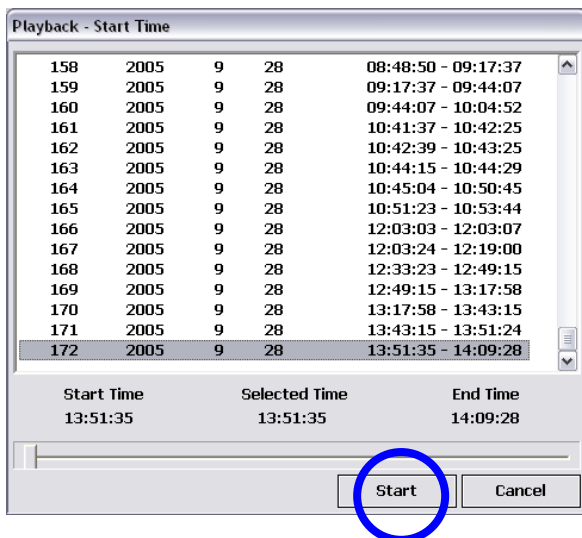

The Window on the left will show a list of video in 500Mb sections within the time period set. Highlight the relevant section and click "START"

## Quantum Evolution installation and user manual

Video will be displayed in the following screen, use the button described previously to pause / fast forward etc.



### PTZ CONTROL VIA THE SOFTWARE CLIENT

The software front end is capable of controlling PTZ cameras on site

#### Pan/Tilt, Zoom/Focus, OSD



**Pan / Tilt** - Using arrow key, controls the Pan/Tilt ( 4 channel doesn't support P/T/Z control)

**Zoom / Focus** - Using arrow key, controls Zoom, Focus (4channel doesn't support P/T/Z control)

**OSD** - Whether displays or not on OSD during live / playback



## SETUP



Click the Set-Up button

## REMOTE SET UP

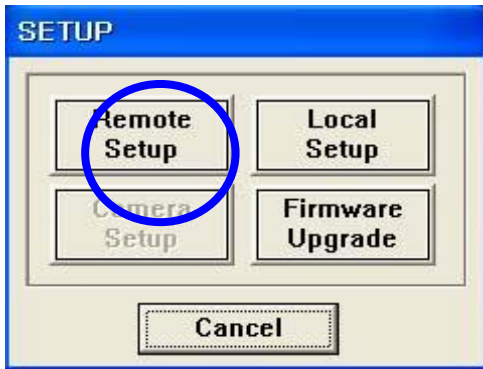

Setup menu is composed of:

- 1) Remote Setup – Set up Quantum
- 2) Local Setup –Set up of software on PC
- 3) Firmware Upgrade – Upgrading of Quantum firmware over the Network.

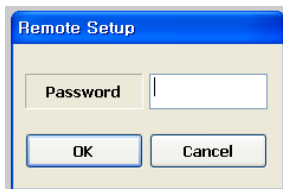

When you select 'Remote Setup' menu, Password is required to go into menu.

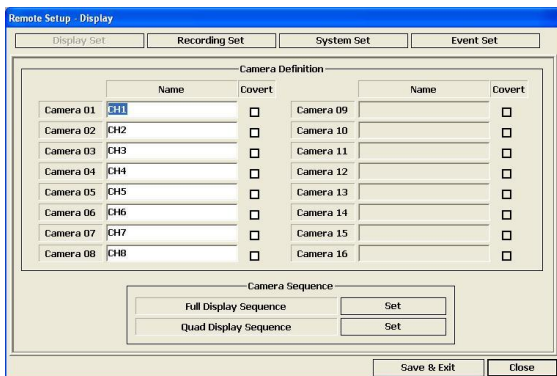

**Display Set** menu, Camera titles and sequences can be set from this page, click SAVE AND EXIT on completion.

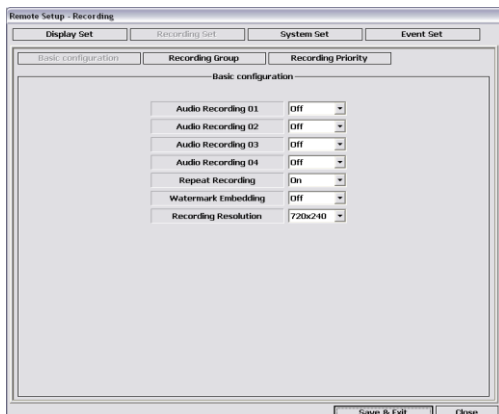

**Recording Set** menu, this has 3 sub-menus:

- 1) Basic Configuration –
  - a. Audio
  - b. Repeat record
  - c. Watermarking
  - d. Record resolution
- 2) Recording Group –
  - a. Normal
  - b. Alarm
  - c. Motion
  - d. Schedule
- 3) Record Priority.

# Quantum Evolution installation and user manual

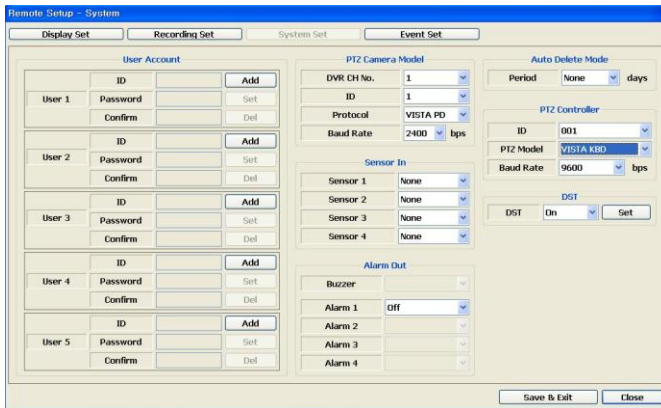

**System set menu** – This allows the setup of:

- User accounts and password
- PTZ control
- Alarm inputs (Sensors)
- Alarm out
- Auto delete mode

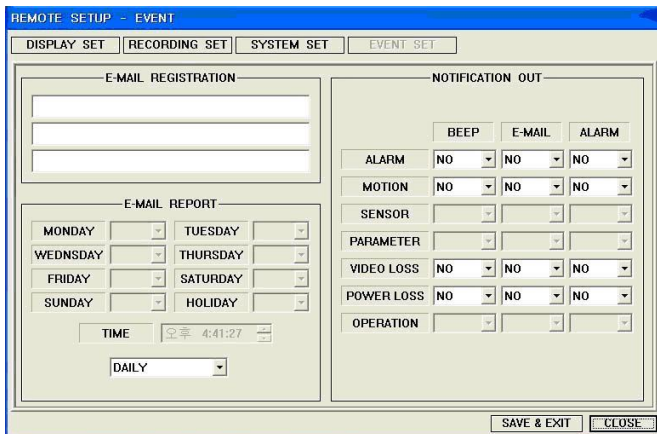

**Event Set menu** – This allows the setup of:

- E-mail registration
- E-mail reports
- Notification out

## Local setup



**Local setup menu** – allows the set up of the following items on the PC.

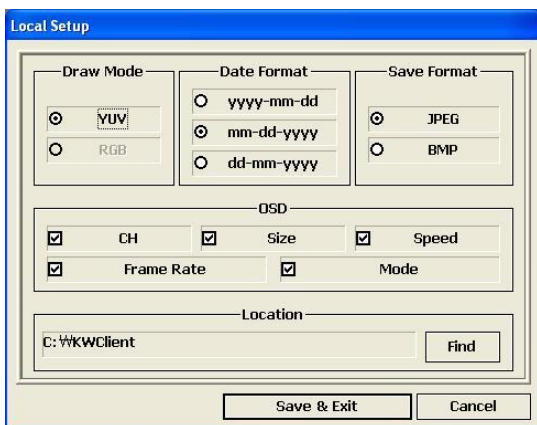

- 1) Draw Mode: User can select between YUV format using Direct X or RGB.
- 2) Date Format: Select the time/ date format.
- 3) Save Format: Select the saving file format from JPEG or BMP.
- 4) OSD:
  - (1) CH1, CH2, ...
  - (2) Size: Actual video size.  
NTSC - 720x240, 360x240,  
PAL – 720x288, 360x288
  - (3) Speed: Playback Speed
  - (4) Rate: Frame number per sec.
  - (5) Mode: Live (Live monitoring) /  
R-Play (Remote play) /  
L-Play (Local play)

### Firmware Upgrade



**Firmware Upgrade menu** – This allows the Quantum to be upgraded across the network.

The new version of firmware needs to be stored in C:\KWClient\Upgrade. If a newer version is found then a 'New Program Found!' message will be shown

If version is not higher in C:\KWClient\Upgrade folder, then a 'New Program Not Found' message will be displayed.

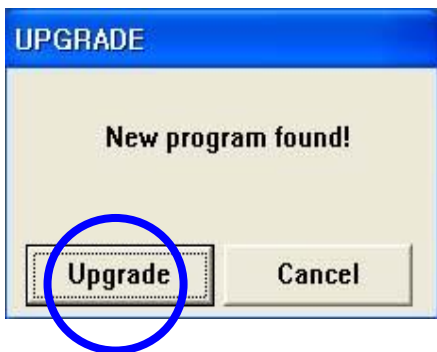

When 'New Program found' message is displayed, please click the 'Upgrade' button.

Note: For system stability, please "stop" the system recording, before upgrading.

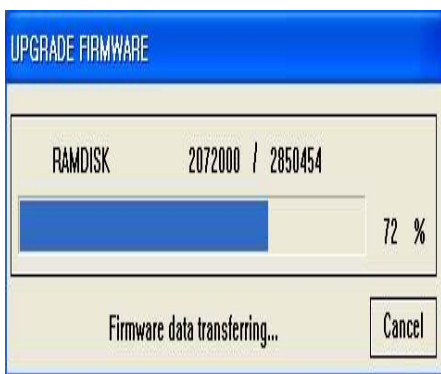

As the firmware upgrade proceeds this time bar will be shown.

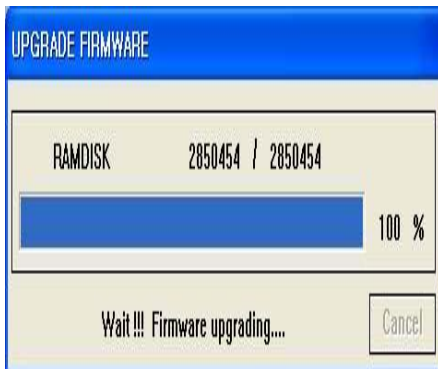

When firmware Upgrade is done successfully, 'Firmware Upgrade success!' message will be displayed.



The local system will re-boot automatically.

## Explanation of buttons on screen

### Image Save



This is for saving format. Either JPEG or BMP. The file will be stored C:\KWClient\Save.

### Stop



This is for stopping Downloading.

### Connect



Re-connecting when access has failed

### OSD



Whether displays or not on OSD during live / playback

### Log / Event / Info / Status



The relevant information like Log, Event, Info, Status will be shown as below.

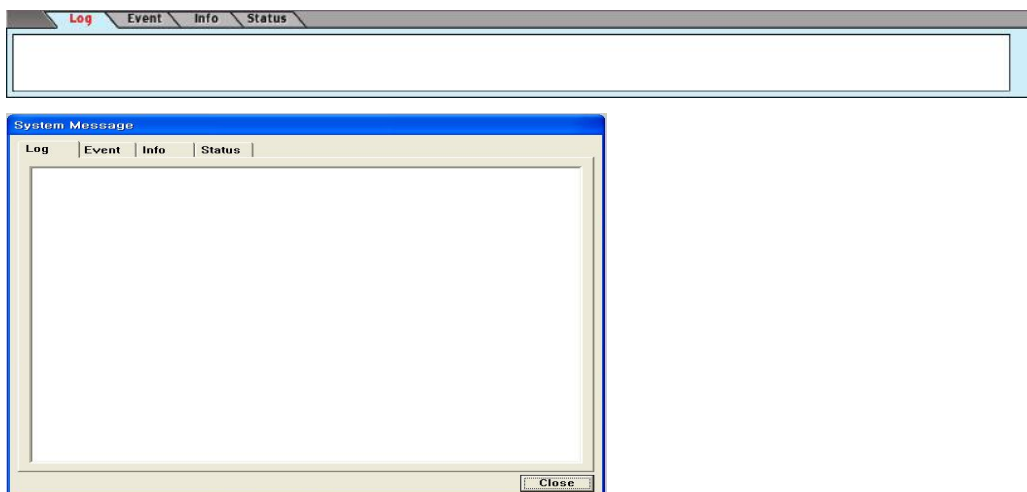

### Event Clear



The relevant OSD turns to green colour when DVR has an event like Alarm, Motion, and Video-loss.



Reset for event button (event clear)

### Timer



This shows the software PC timer. In live it shows the PC time. It shows the time the recording data belongs to during playback. The timer format is according to date format specified on the “local Setup”.

### Exit



## APPENDIX 1

### ALARM SENSOR INSTALLATION

#### 1. Components

- 1) External Sensor: 1
- 2) DVR System: 1

#### 2. Inner Circuit for Sensor Input

The inner circuit of Quantum DVR is as follows,

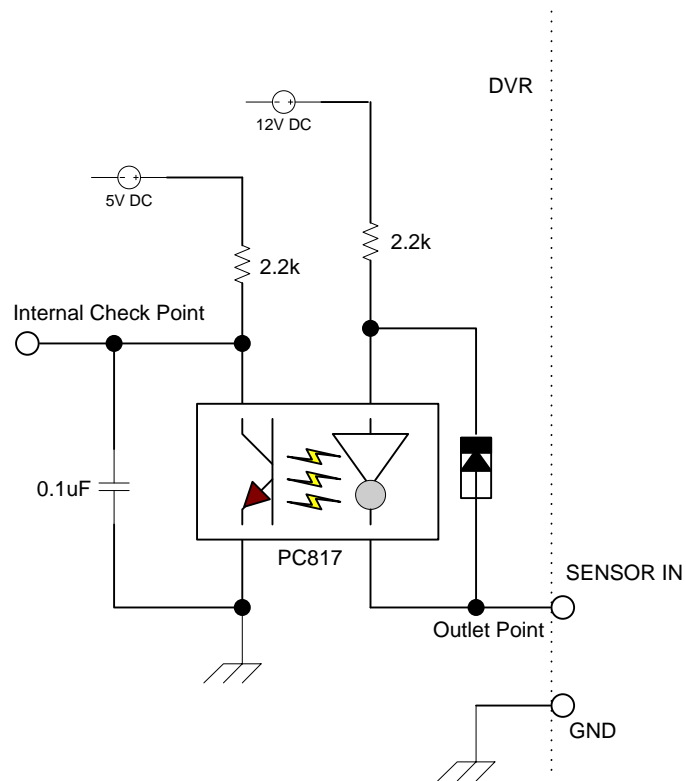

- ① PC817 : Photo Coupler
- ② The Specification of PC817



## ■ Absolute Maximum Ratings

Parameter		Symbol	Rating	Unit
Input	Forward current	IF	50	mA
	*1Peak forward current	I FM	1	A
	Reverse voltage	V R	6	V
	Power dissipation	P	70	mW
Output	Collector-emitter voltage	V CEO	35	V
	Emitter-collector voltage	V ECO	6	V
	Collector current	IC	50	mA
	Collector power dissipation	P C	150	mW
Total power dissipation		P tot	200	mW
*2Isolation voltage		V iso	5 000	V rms
Operating temperature		T opr	-30 to +100	°C
Storage temperature		T stg	-55 to +125	°C
*3Soldering temperature		T sol	260	°C

\*1 Pulse width  $\leq 100 \mu s$ , Duty ratio : 0.001

\*2 40 to 60% RH, AC for 1 minute

\*3 For 10 seconds

## ■ Electro-optical Characteristics

Parameter		Symbol	Conditions	MIN.	TYP.	MAX.	Unit
Input	Forward voltage	V F	IF = 20mA	-	1.2	1.4	V
	Peak forward voltage	V FM	IFM = 0.5A	-	-	3.0	V
	Reverse current	IR	V R = 4V	-	-	10	$\mu A$
	Terminal capacitance	Ct	V = 0, f = 1kHz	-	30	250	pF
Output	Collector dark current	ICEO	V CE = 20V	-	-	10 <sup>-7</sup>	A
Transfer characteristics	*4Current transfer ratio	CTR	IF = 5mA, V CE = 5V	50	-	600	%
	Collector-emitter saturation voltage	V CE( sat)	IF = 20mA, IC = 1mA	-	0.1	0.2	V
	Isolation resistance	R ISO	DC500V, 40 to 60% RH	5 x 10 <sup>10</sup>	10 <sup>11</sup>	-	$\Omega$
	Floating capacitance	Cf	V = 0, f = 1MHz	-	0.6	1.0	pF
	Cut-off frequency	fc	V CE = 5V, IC = 2mA, RL = 100 $\Omega$ , -3dB	-	80	-	kHz
	Response time	Rise time	tr	V CE = 2V, IC = 2mA, RL = 100 $\Omega$	-	4	18
Fall time		tf		-	3	18	$\mu s$

### 1. SENSOR Install Processing

① Please refer the below block diagram.

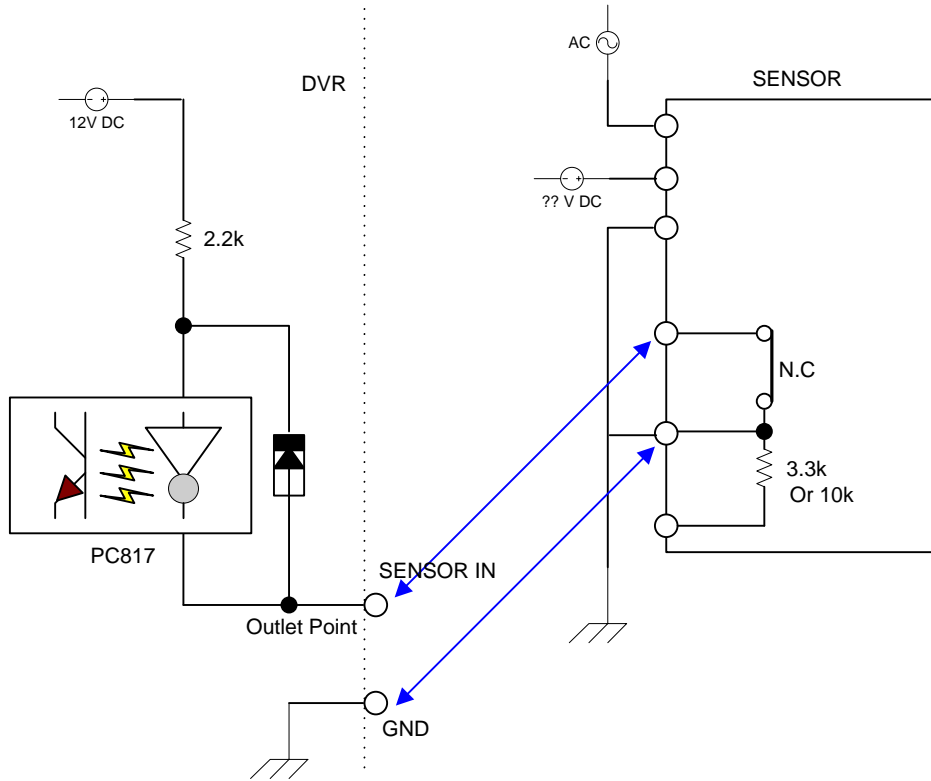

## APPENDIX 2

### DYNAMIC IP (Supporting DDNS Server)

1. Visit [www.ddns-dvr.com](http://www.ddns-dvr.com) to get the DDNS user ID & PW as well as Host name.

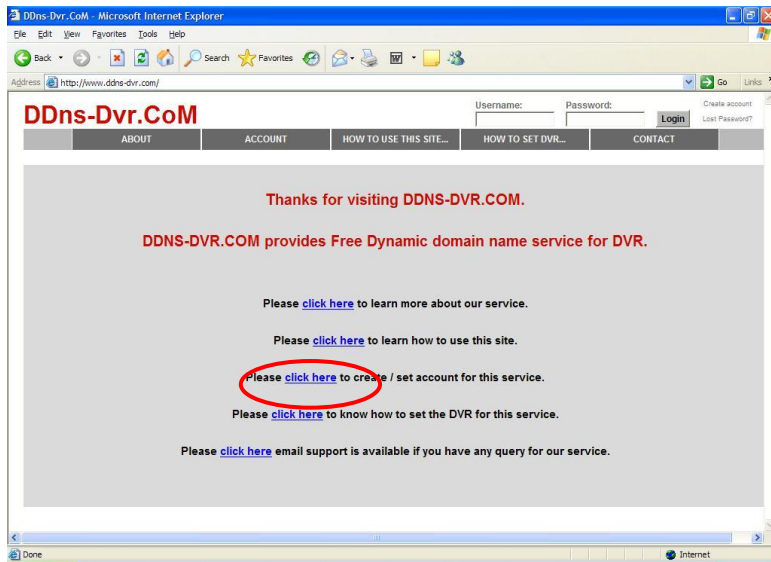

2. Click to create / set account of “Dynamic DNS”.

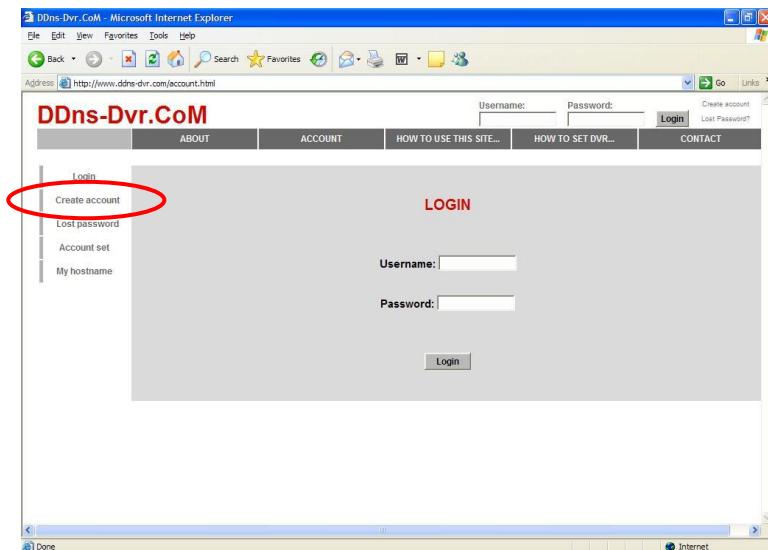

3. Select “Create Account” menu.

## 4. Create Account.

The screenshot shows the 'CREATE ACCOUNT' page on the DDns-Dvr.CoM website. The page is viewed in Microsoft Internet Explorer. The address bar shows the URL: [http://www.ddns-dvr.com/create\\_account.php](http://www.ddns-dvr.com/create_account.php). The page has a navigation menu with the following items: ABOUT, ACCOUNT, HOW TO USE THIS SITE..., HOW TO SET DVR..., and CONTACT. The 'ACCOUNT' menu item is selected. The main content area is titled 'CREATE ACCOUNT' and contains a form with the following fields:

- Username:  Check ID
- Password:
- E - mail:
- Hostname:  .DDns-Dvr.CoM
- IP Address:  203.229.230.243

At the bottom of the form, there are two buttons: 'Create' and 'Backward'. A red circle highlights the 'Create account' link in the left sidebar.

- > Fill in all blanks in order to create new account.  
ID & Password will be emailed you when the account is created well.

## APPENDIX 3

### SETUP FOR DVR PORT/ WEB SERVER PORT USING IP SHARING ROUTER

(Port Forwarding)



1) To use IP sharing Router, “Use Dynamic IP” should be set to “NO”.

- DVR Port: This can be set to any number between 2000 to 65535.

- Web Server Port: this can be set to any number between 2000~65535, as long as it is not the same as the DVR Port number

2) Setup “virtual server” on IP sharing Router

It is for setting virtual server to forward IP which is allotted to DVR.

> For example,

DVR-1, IP : 192.168.10.11, DVR Port : 9000, Web Server Port : 9001

If DVR-1 is configured as above, the virtual server on IP sharing router is as follows.

1) PC Server Name : DVR-1(IP 192.168.10.11)

Protocol : TCP, Internal Port : 9000, External Port : 9000

2) PC Server Name : DVR-1 (IP 192.168.10.11)

Protocol : TCP, Internal Port : 9001, External Port : 9001

\* For more detail, please refer to relevant IP sharing manual.

(3) ‘DDNS’ Setup on IP sharing router

DDNS configuration is not needed in case of fixed IP.

- (4) To connect DVR-1 with Internet Explorer, <http://dvr-1.ddns-dvr.com:9001>,  
to connect DVR-1 with CD installer, <http://dvr-1.ddns-dvr.com:9000>.

## APPENDIX 4

### MAKING A PARTITION ON AN EXTERNAL USB HARD DRIVE

To back up to USB HDD, the USB HDD should be formatted first on PC. The Quantum EVO supports the FAT32 file system, of which maximum size is 100GB for one partition. Please refer to the following procedure to make a partition and format on PC.

\*If the HDD capacity is under 100GB, don't need to make a partition and simply connect to DVR directly.

1. Select Control panel-> administrative Tools.

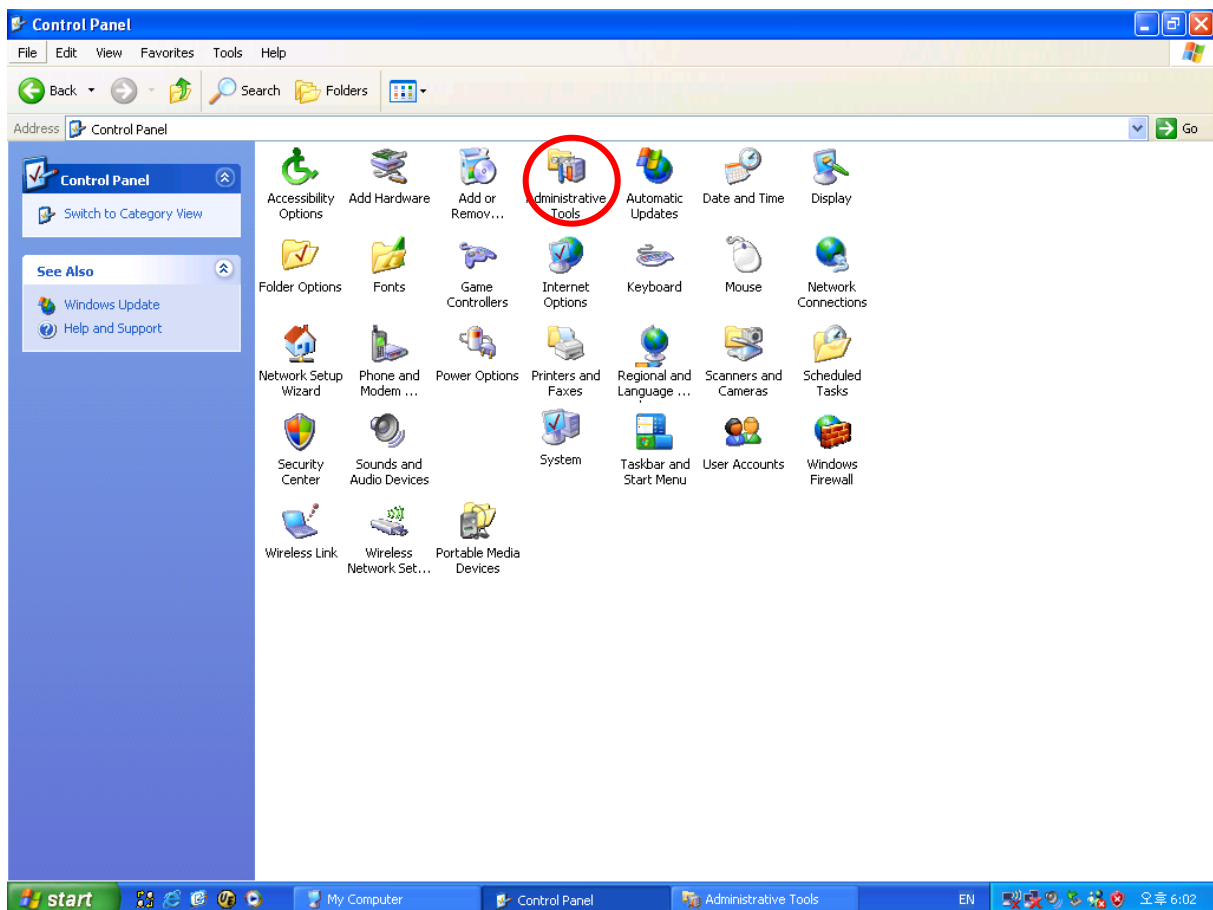

## 2. Select “Computer Management”

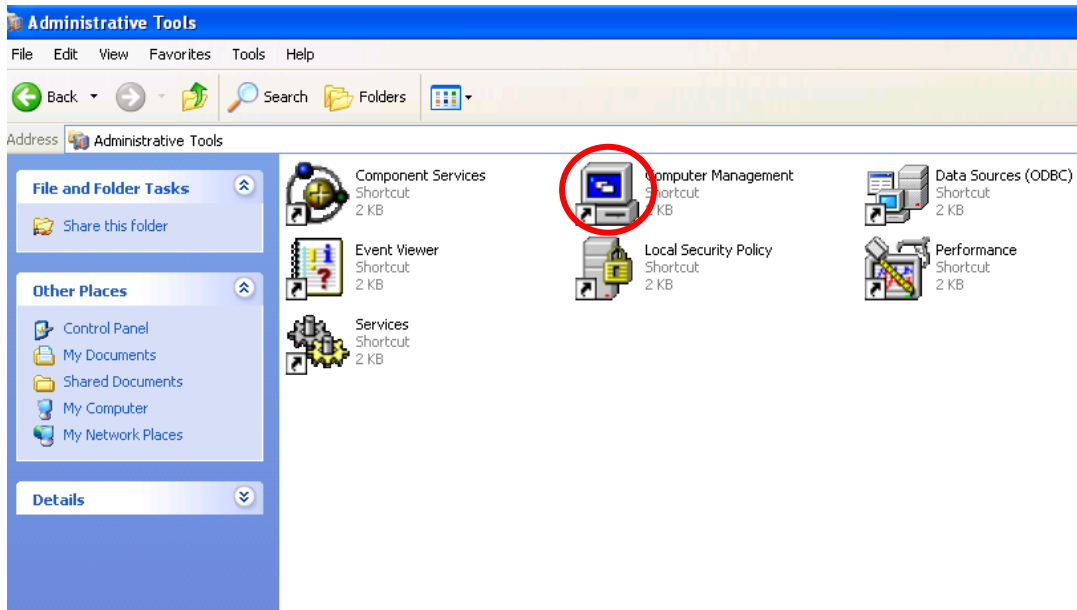

## 3. Select “Disk Management”.

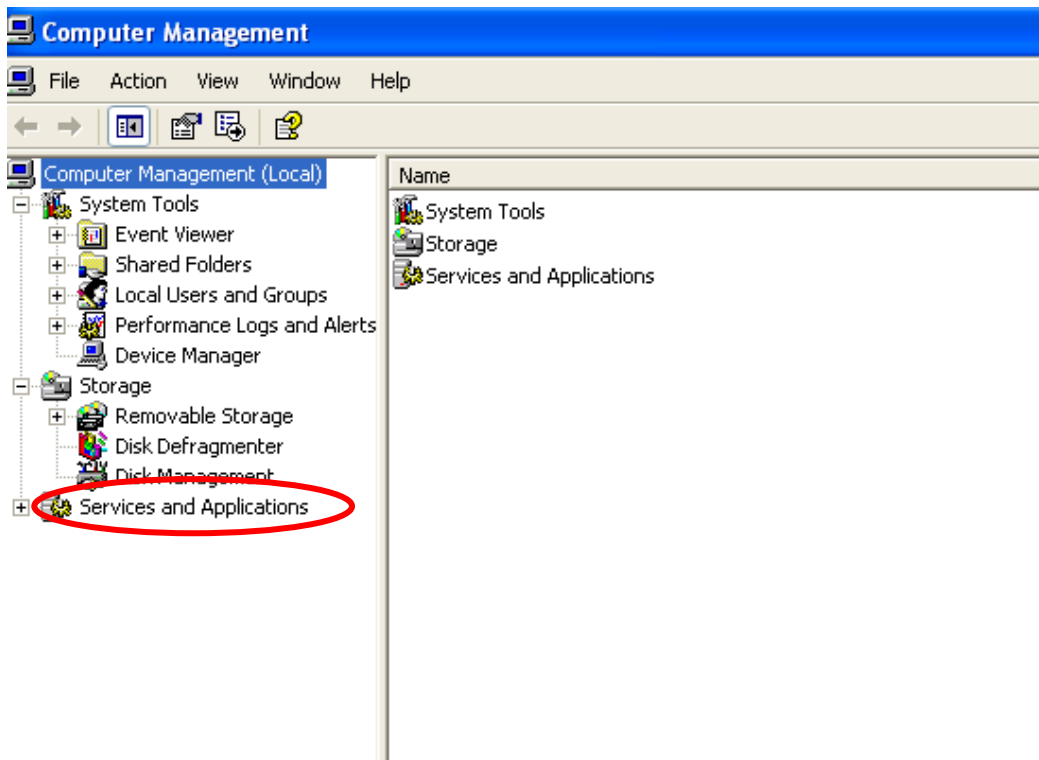



4. Click right mouse button and select “New Partition”.

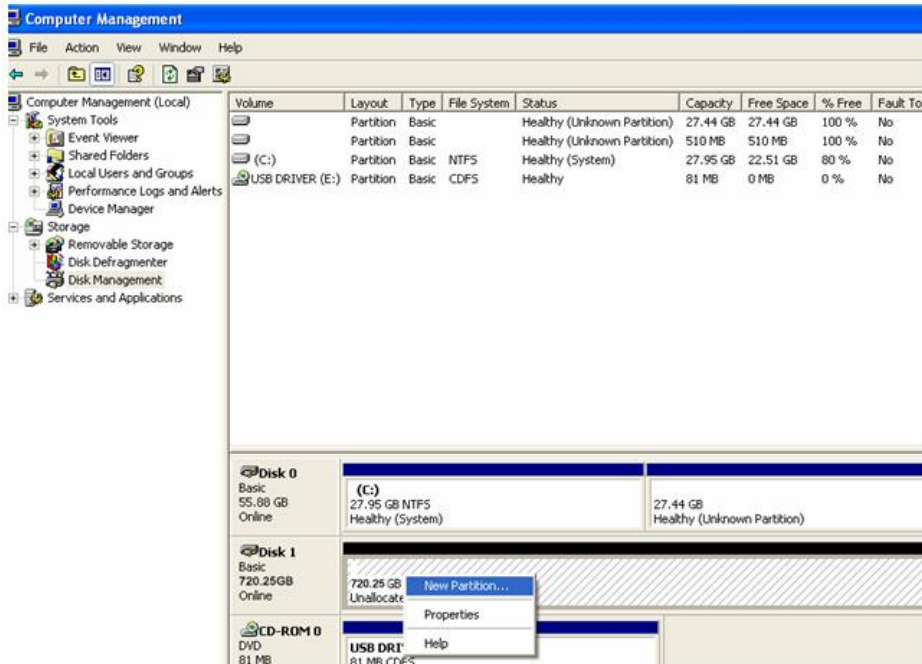

5. Follow “New Partition Wizard” procedure as below.

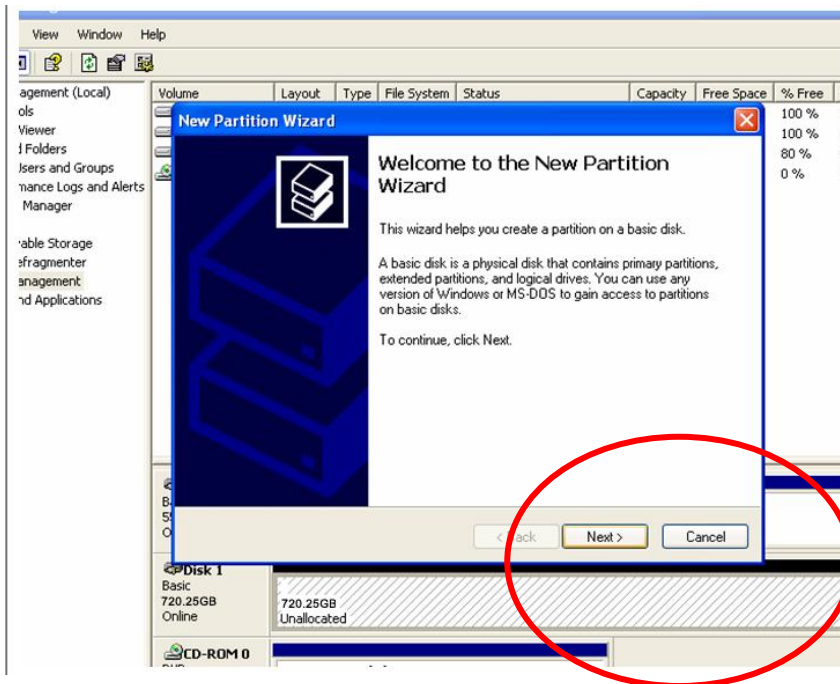

6. Select the Primary partition option.

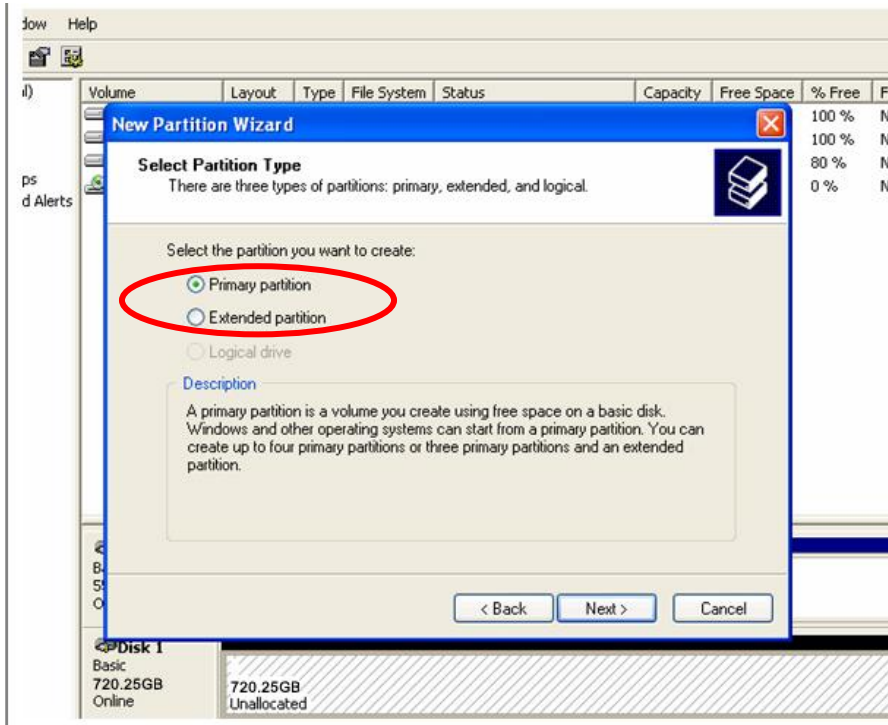

7. Maximum is 100GB at FAT32 file format.

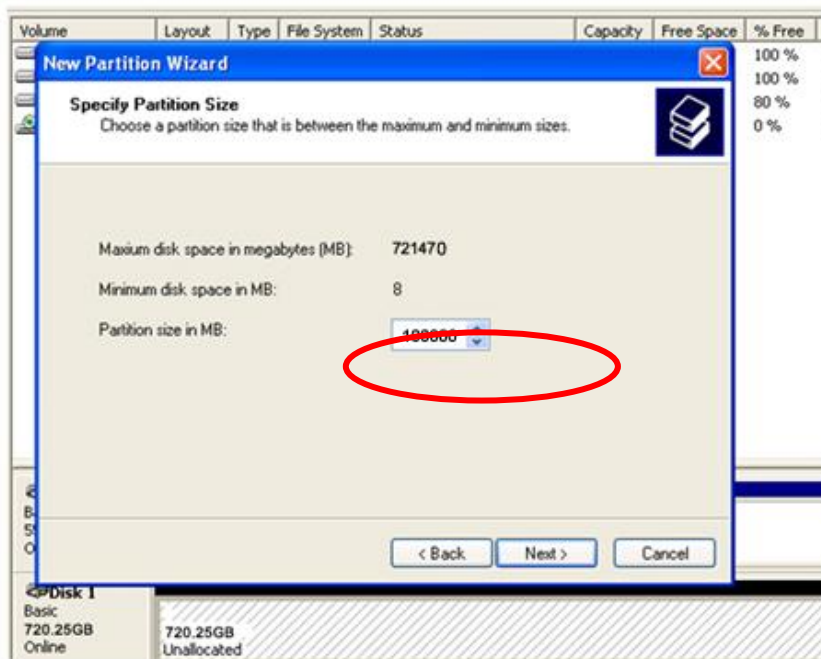

## 8. Assign drive letter

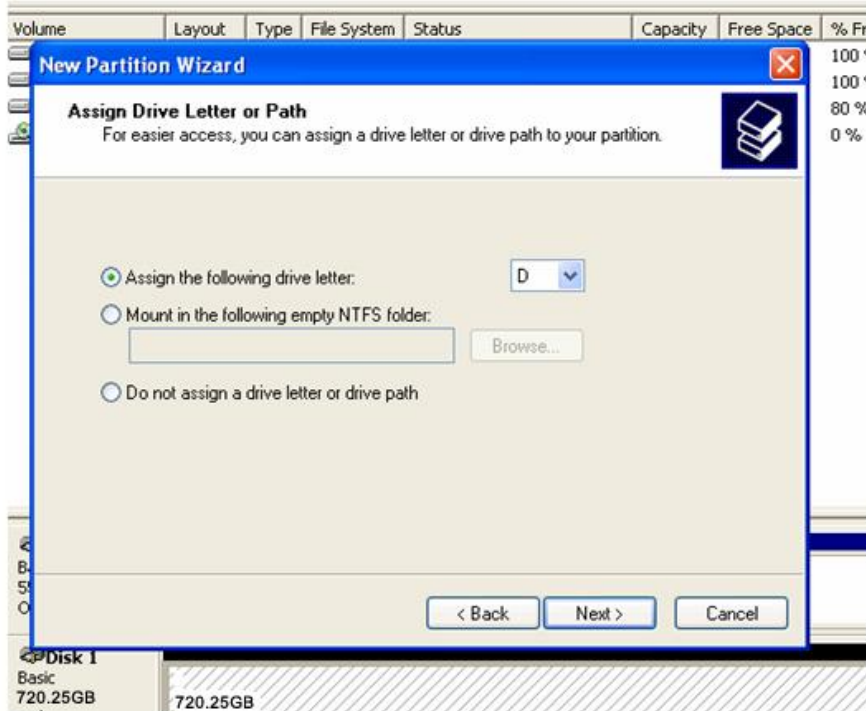

## 9. Format the partition to FAT32

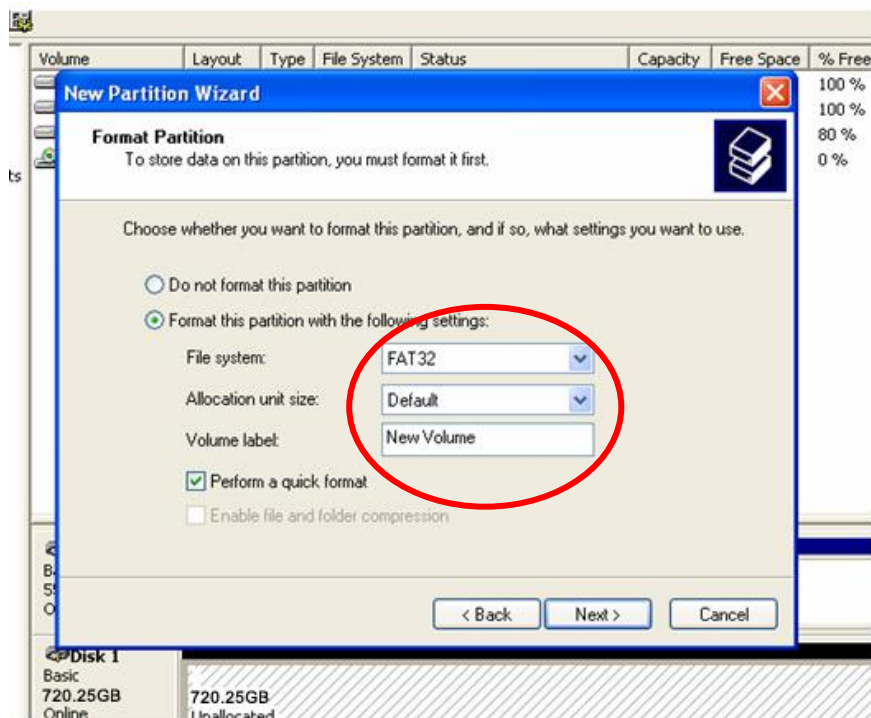

10. At this stage, New Partition has been made.



11. Check New partition was created correctly.(Format will run automatically)

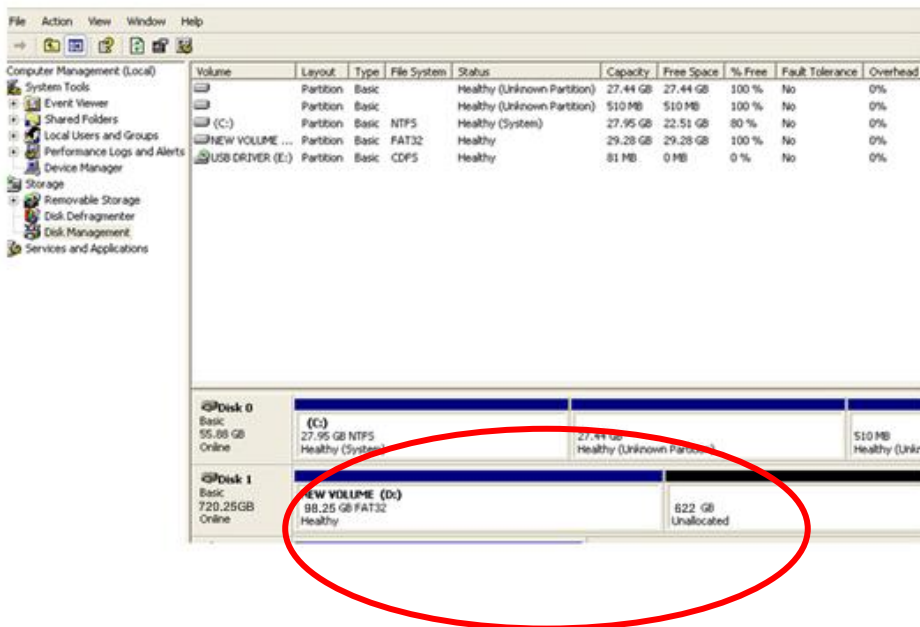

12. Check New Partition was created correctly

# Quantum Evolution installation and user manual

## APPENDIX 5

### SPECIFICATION

Model		MPEG-4 120fps DVR			
		4CH USB Backup only / 4CH	8CH	16CH	
Video	Camera Input(Ntsc,Pal)	4	8	16	
	Output	1 BNC, 1 S-Video, 1 VGA			
Audio	Audio Input	1 RCA	4 RCA		
	Output	1 RCA			
Sensor in / Alarm Out		4/1			
Operating System		Embedded Linux OS			
Display	Speed	120fps	240fps	480fps	
	Resolution(Pixel)	720 X 480(NTSC), 720X576(PAL)			
	Split Screen	1,4	1, 4, 8, SEQ.	1, 4, 8, 16, SEQ.	
Recording	Compression	MPEG-4			
	Resolution(Pixel)	720X240, 360 X 240 (NTSC) / 720 X 288, 360 X 288 (PAL)			
	Picture Quality	3 Steps (High, Middle, Low)			
	Mode	Normal, Motion, Alarm, Schedule			
	Priority	Alarm > Motion > Schedule > Normal			
	Speed	Total	120fps(360X240), 60fps(720X240) / 100fps(360X288), 50fps(720X288)		
		Each Channel	NTSC	30fps(360X240) 15fps(720X240)	15fps(360X240) 7.5fps(720X240)
PAL			25fps(360X288) 12.5fps(720X288)	12.5fps(360X288) 6.25fps(720X288)	6.25fps(360X288) 3.125fps(720X288)
Water Marking & Scrambling		Our Own Algorithm			
Playback	Display	1,4	1,4,8	1,4,8,16	
	Search Mode	Date & Time, Calendar, Event			
	Speed	Normal, REW & FF(Recorded Speed X2, X4, X16), Frame to Frame, Pause			
	Device	Internal HDD			
	Still Image Capture & Save	JPEG Compression or AVI Format & USB I/F Device(Memory Stick)			
Network	Network Interface	Ethernet			
	Protocol	TCP/IP, SMTP, HTTP, DHCP, PPPOE(ADSL)			
	Serial Communicaton	RS-485 1EA	RS-232 1EA, RS-485 1EA		
	Application	Windows 2000 / XP(PC Client System) / Vista			
	Web Browser	Internet Explorer 5.0 Over(DVRs Control or Viewing), Network CD			
	Event Transport	Event notification when event occurs			
Back Up	Interface	USB 2.0			
	Backup Device	External Device	Internal CD&DVD-RW/External HDD,CD&DVD-RW,Network,Memory Stick		
Control	Motion Detection	Each Control / Channel			
		Sensitivity : 3 Steps for each channel			
		Area : Programmable motion detection area for each camera individually			
	Alarm Hold Time	5~240 SEC			
	Event Log	Up to the 256 events(Alarm, Motion, Video&Power Loss, Power&Record On/Off)			
	Remote Controller	NIL	IR Remote Control		
Pan/Tilt Camera	Control From RS485 Interface				
Others	HDD	1HDD	Supports Max. X 2HDDs (SATA)		
	Power Source	100~240V AC, 50~60HZ			
	Power Consumption	36W	70W		
	Operating Temperature	5~40℃ (41~104F)			
	Relative Humidity	Maxium 80% Non-Considering			
	Weight	Net	4.0Kg( 4ch USB Backup only ) / 6.0Kg		
		Gross(Box)	5.0Kg( 4ch USB Backup only ) / 7.0Kg		
	Dimension	Net	350(W)X250(D)X70(H)mm ( 4ch USB Backup only ) / 450(W)X370(D)X90(H)mm		
Gross(Box)		400(W)X340(D)X170(H)mm ( 4ch USB Backup only ) / 500(W)X460(D)X190(H)mm			

\*Design and product specifications subject to change without notice\*

Subject to change without notice

NORBAIN SD LTD  
210 Wharfedale Road  
Winnersh Triangle  
Wokingham  
Berkshire  
RG41 5TP  
United Kingdom  
01189 125 000